

**HORIBA**  
Scientific

# Instruction Manual

Ammonia Electrode  
5002S-10C

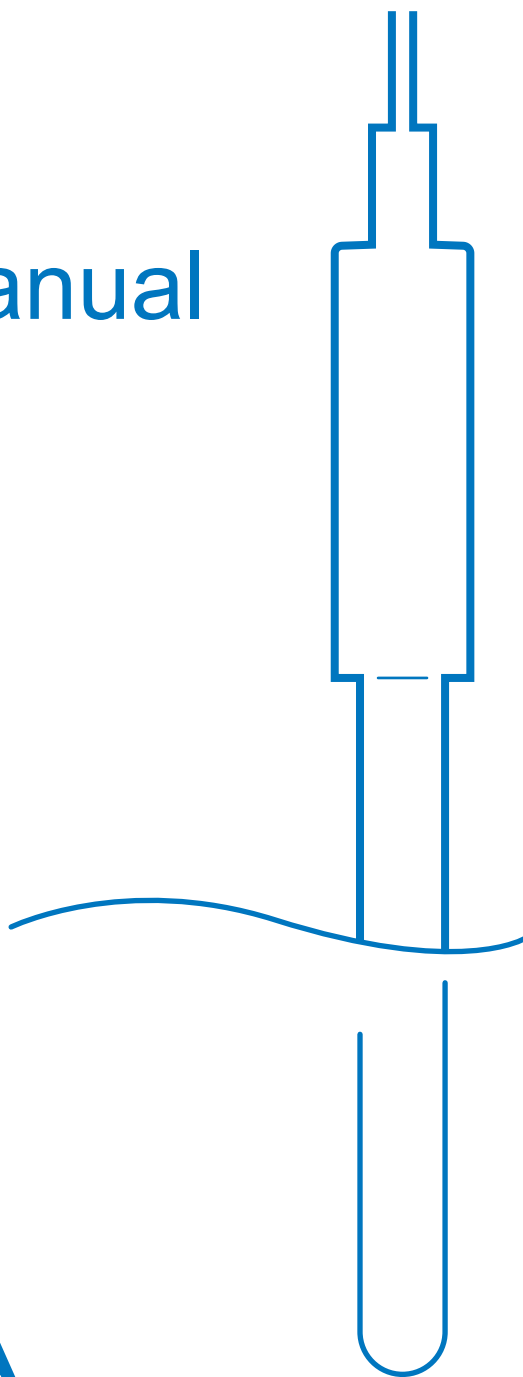

**LAQUA**  
ELECTRODE

# Preface

This manual describes operation of the ammonia electrode.

Be sure to read this manual before using the product to ensure proper and safe operation of the product.

Also safely store the manual so it is readily available whenever necessary.

Please contact HORIBA Advanced Techno if any points regarding safety come to your attention during use.

Product specifications and appearance, as well as the contents of this manual are subject to change without notice.

## ■ Warranty and responsibility

---

This product is not covered by warranty because it is a consumable item. HORIBA Advanced Techno Co., Ltd. SHALL NOT BE LIABLE FOR ANY DAMAGES RESULTING FROM ANY MALFUNCTIONS OF THE PRODUCT, ANY ERASURE OF DATA, OR ANY OTHER USES OF THE PRODUCT.

## ■ Trademarks

---

- QR code is a trademark of DENSO WAVE INCORPORATED.
- Company names and brand names are either registered trademarks or trademarks of the respective companies. (R), (TM) symbols may be omitted in this manual.

## ■ Regulations

---

### ◆ EU regulations

<p><b>Conformable standards</b> This equipment conforms to the following standards:</p> <p> <b>RoHS: EN50581</b> 9. Monitoring and control instruments</p>	<p><b>Authorised representative in EU</b> HORIBA UK Limited 2 Dalston Gardens, Stanmore, Middx HA7 1BQ, UK</p>
---	--

## ◆ China regulations

### 标记的意义 Meaning of Marking



本标记适用在中华人民共和国销售电器电子产品，标记中央的数字表示环境保护使用期限的年数。（不是表示产品质量保证期间。）只要遵守这个产品有关的安全和使用注意事项，从制造日开始算起在这个年限内，不会给环境污染、人体和财产带来严重的影响。请不要随意废弃本电器电子产品。

This marking is applied to electric and electronic products sold in the People's Republic of China. The figure at the center of the marking indicates the environmental protection use period in years. (It does not indicate a product guarantee period.) It guarantees that the product will not cause environment pollution nor serious influence on human body and property within the period of the indicated years which is counted from the date of manufacture as far as the safety and usage precautions for the product are observed. Do not throw away this product without any good reason.

### 产品中有害物质的名称及含量

#### Name and amount of hazardous substance used in a product

部件名称 Unit name	有害物质 Hazardous substance					
	铅 Lead (Pb)	汞 Mercury (Hg)	镉 Cadmium (Cd)	六价铬 Hexavalent chromium (Cr (VI))	多溴联苯 Polybromo- biphenyl (PBB)	多溴二苯醚 Polybromo- diphenyl ether (PBDE)
本体 Main unit	×	○	×	○	○	○
电缆 Cable	×	○	○	○	○	○

本表格依据 SJ/T 11364 的规定编制。  
This form is prepared in accordance with SJ/T 11364

○：表示该有害物质在该部件所有均质材料中的含量均在 GB/T 26572 规定的限量要求以下。  
Denotes that the amount of the hazardous substance contained in all of the homogeneous materials used in the component is below the limit on the acceptable amount stipulated in the GB/T 26572.

×：表示该有害物质至少在该部件的某一均质材料中的含量超出 GB/T 26572 规定的限量要求。  
Denotes that the amount of the hazardous substance contained in any of the homogeneous materials used in the component is above the limit on the acceptable amount stipulated in the GB/T 26572.



## ■ For your safety

---



### ◆ Hazard classification and warning symbols

Warning messages are described in the following manner. Read the messages and follow the instructions carefully.

- **Hazard classification**



 <b>DANGER</b>	This indicates an imminently hazardous situation which, if not avoided, will result in death or serious injury. This is to be limited to the most extreme situations.
 <b>WARNING</b>	This indicates a potentially hazardous situation which, if not avoided, could result in death or serious injury.
 <b>CAUTION</b>	This indicates a potentially hazardous situation which, if not avoided, may result in minor or moderate injury. It may also be used to alert against unsafe practices.

- **Warning symbols**

	Description of what should be done, or what should be followed
	Description of what should never be done, or what is prohibited

## ◆ Safety precautions

This section provides precautions for using the product safely and correctly and to prevent injury and damage. The terms of DANGER, WARNING, and CAUTION indicate the degree of imminency and hazardous situation. Read the precautions carefully as it contains important safety messages.

 <b>CAUTION</b>	
	<p><b>Precautions for chemicals</b></p> <p>Solutions used for calibration and measurement must not come in contact with the skin, or consumed.</p> <p>These solutions stimulate the eyes and skin. If these solutions come in contact with your skin or eyes, flush immediately with running water.</p> <p>If you drink these solutions by accident, immediately seek medical advice.</p> <p>When you handle these solutions, make sure to wear latex gloves, protective glasses, etc.</p>
	<p><b>Precautions against cuts and incisions</b></p> <p>You may get injured by glass fragments.</p> <p>The electrode inside the main unit is made of glass.</p> <p>Be careful not to break it.</p>

## ■ Product handling information

---

### ◆ Operational precautions

Use of the product in a manner not specified by the manufacturer may impair the protection provided by the product. And it may also reduce product performance.

Exercise the following precautions:

- Use the supplied internal solution for the ammonia electrode. Using any other internal solutions may cause measurement errors.
- If the membrane of the glass electrode for pH measurement is dry, soak the membrane of the glass electrode for pH measurement in the internal solution for at least 12 hours. Using it in a dry state will cause measurement errors.
- Do not get the electrode connector wet or touch it with dirty hands. It may cause a failure.
- Do not touch a hard surface with the electrode. It may cause a failure.
- Only use the product including accessories for their intended purpose. HORIBA Advanced Techno assumes no liability when they are used for any other products.





### ◆ Disposal of the product

When disposing of the product, follow the related laws and/or regulations of your country.

## ■ Manual information

### ◆ Description in this manual

The following explains the icons used in this manual.

Icon	Meaning
 Note	This interprets the necessary points for correct operation and notifies the important points for handling the product.
 Tip	This indicates reference information.
	This indicates the part where to refer for information.
 View video	This indicates that you can access the instruction video on the web page. Access the webpage by using the QR Code.

### ◆ Original language

This is the English translation of an original Japanese document.

### ◆ Documents related to this product

The following documents are related to this product.

- **Ammonia Electrode Instruction Manual (this manual)**

This manual mainly discusses how to operate the ammonia electrode.

- **Meter Instruction Manual**

This manual mainly discusses how to operate the meter to which the ammonia electrode is connected.

- **Electrode Stand Instruction Manual**

This manual mainly discusses how to operate the electrode stand which holds the ammonia electrode. The electrode stand is optional for the portable meter.

# Memo



# Contents

<b>Before Use</b>	<b>1</b>
Confirmation of the items included in the package . . . . .	2
About this product . . . . .	3
Measurement procedure . . . . .	5
<b>Electrode Preparation</b>	<b>7</b>
Assembling the electrode . . . . .	8
Rinsing the electrode . . . . .	12
Connecting the electrode to the meter . . . . .	13
<b>Calibration</b>	<b>15</b>
Standard solutions . . . . .	16
Calibration operation . . . . .	17
<b>Measurement</b>	<b>27</b>
Requirements for sample and standard solutions . . . . .	28
Measurement hints . . . . .	29
Measurement units . . . . .	30
Measurement operation . . . . .	31
<b>After Measurement</b>	<b>35</b>
How to keep the electrode . . . . .	36

## **Maintenance** **37**

---

Storage . . . . .	38
Consumables . . . . .	41

## **Troubleshooting** **47**

---

When accurate measurement is not possible . . . . .	48
---	----

## **Reference** **53**

---

Ammonia electrodes . . . . .	54
Characteristics of ammonia electrode . . . . .	57

## **Material** **63**

---

Specifications . . . . .	64
External dimensions . . . . .	65
Consumables . . . . .	66

# Figures

Fig. 1	Included items . . . . .	2
Fig. 2	System configuration. . . . .	3
Fig. 3	Names of parts . . . . .	4
Fig. 4	Structure of ammonia electrode . . . . .	54
Fig. 5	Abundance ratio between ammonia $\text{NH}_3$ and ammonium ion $\text{NH}_4^+$ . . . . .	55
Fig. 6	Conversion from ammonium ions $\text{NH}_4^+$ to ammonia $\text{NH}_3$ . . . . .	55
Fig. 7	Calibration curve of ammonia electrode . . . . .	57

# Tables

Table 1	Ammonium ion concentration measurement unit conversion table . . . . .	30
Table 2	Check list . . . . .	48
Table 3	Relationship between temperature of ion selective electrode and theoretical slope . . . . .	58
Table 4	Relationship between temperature of ammonia electrode and theoretical slope . . . . .	59
Table 5	Specifications of ammonia electrode . . . . .	64
Table 6	Consumables . . . . .	66

# Before Use

This chapter describes what you should know before using the product.

---

## Confirmation of the items included in the package ..... 2

---

## About this product ..... 3

Product features.....3

System configuration .....3

Names of parts.....4

---

## Measurement procedure ..... 5

# Confirmation of the items included in the package

Open the package and make sure that the following items are included.

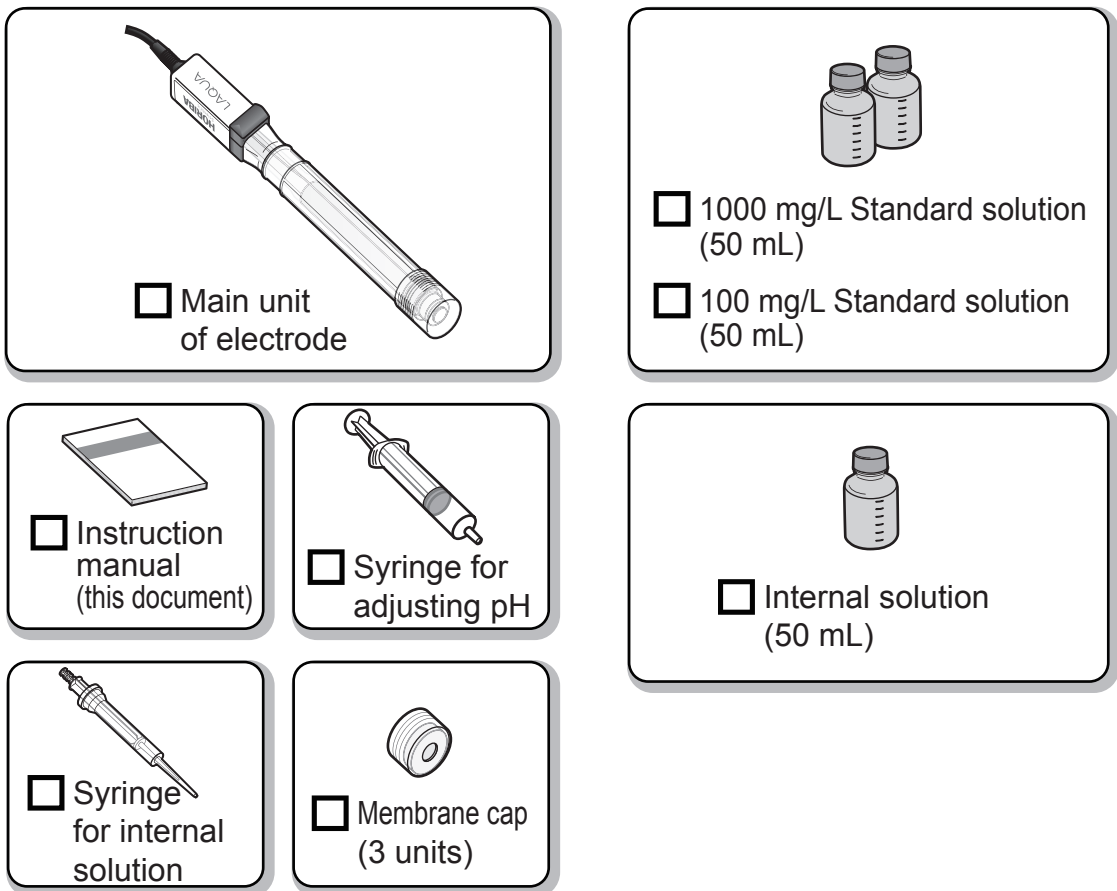



Fig. 1 Included items

This product is a consumable item. For details on purchasing an electrode and reagent, refer to "Consumables" (  page 66).

# About this product

## ■ Product features

The ammonia electrode is configured by a glass electrode for pH measurement, a support pipe, and a membrane cap. The tip of the glass electrode for pH measurement is made of a pH glass ion selective membrane, and the tip of the support pipe has a membrane cap provided with a membrane attached to it.

This product has the following features.

- Ammonium ion concentration can be measured with this one electrode.
- The ammonia electrode consisting of membrane and liquid junction of the glass electrode for pH measurement has a double junction structure. This minimizes the interference on the electrode potential caused by the entry of gas into the internal solution.

## ■ System configuration

This product is used with the meter of HORIBA Advanced Techno connected, which is sold separately. Electrode stand(\*) is also available.

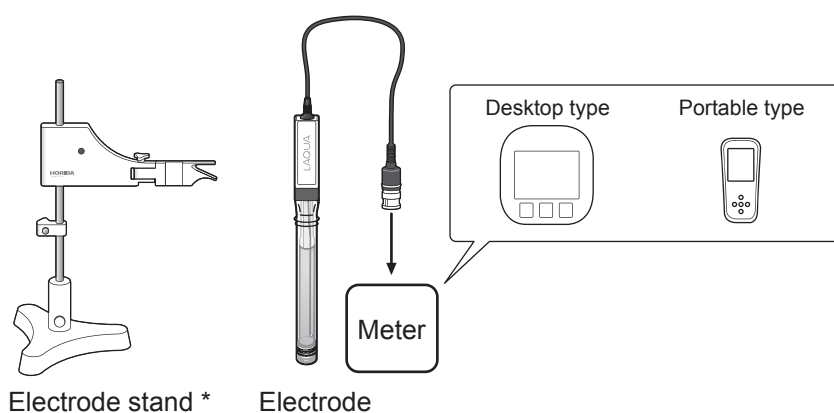

\* This stand is optional for the portable meter.

Fig. 2 System configuration

Refer to the meter instruction manual for more details.

## ■ Names of parts

This product consists of the parts shown in the figure below.

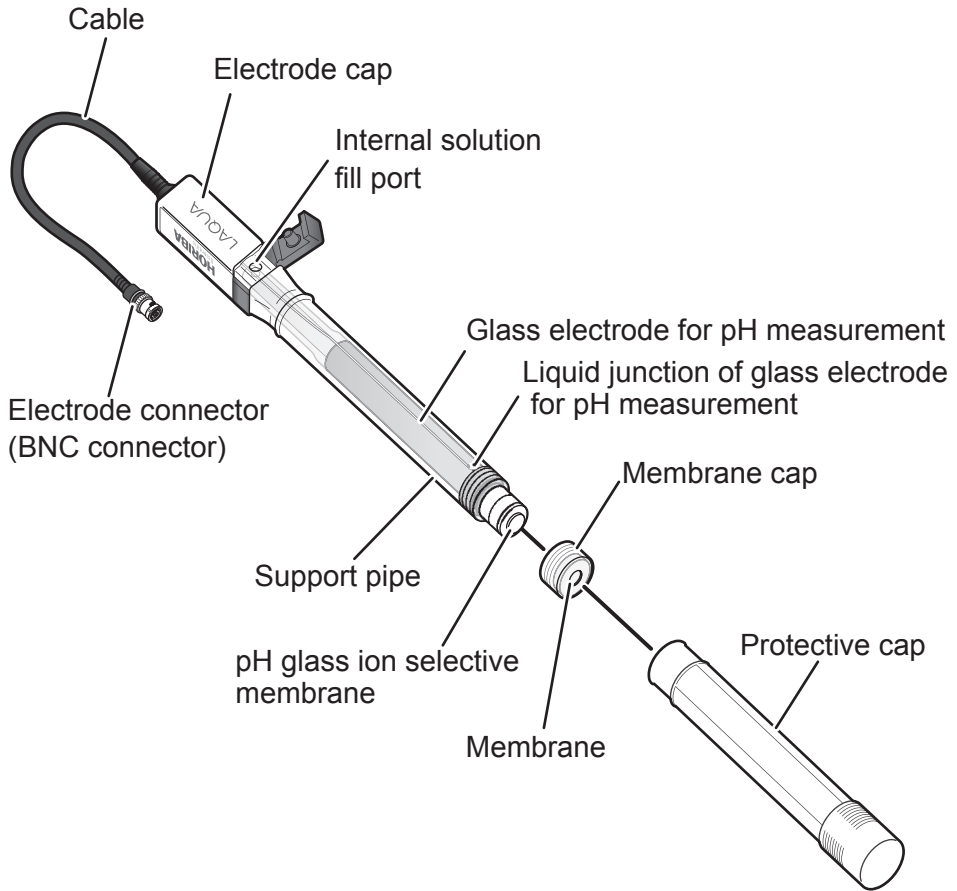

Fig. 3 Names of parts



# Measurement procedure

The following figure shows the procedure for measuring the ammonium ion concentration.

## 1 Measurement preparation

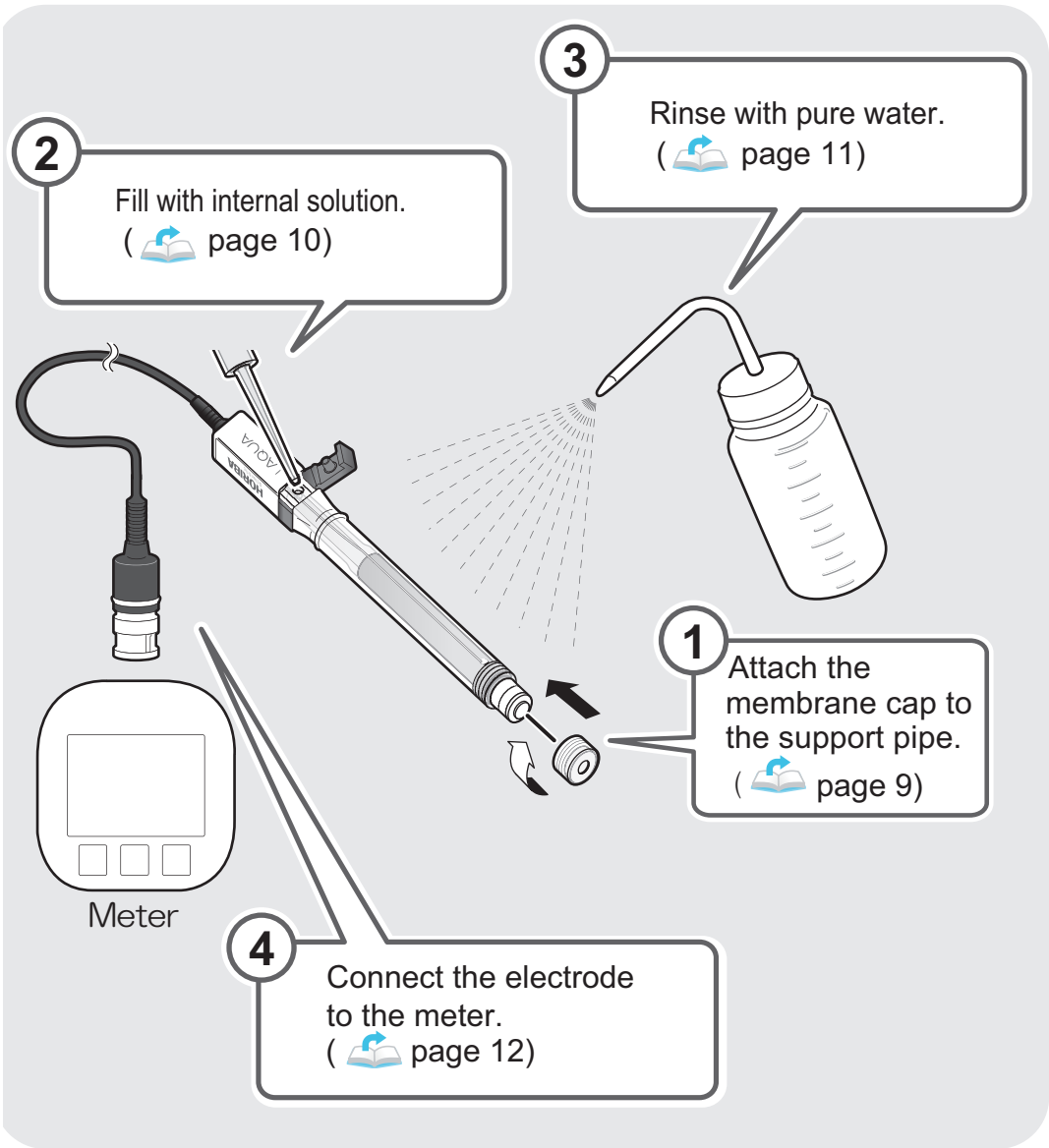

## 2 Calibration

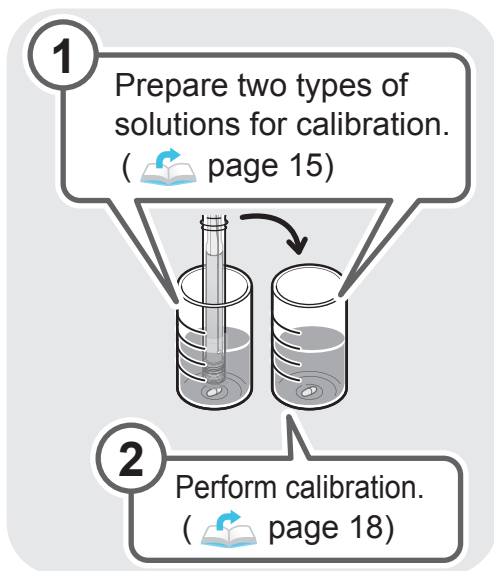

In the following cases, perform conditioning of the electrode before calibration.

- Before the first use
- Before use after storage for one week or longer
- If the electrode is less responsive
- After the replacement of the membrane cap

For details on conditioning, refer to “Conditioning of the electrode”(📖 page 21).

## 3 Measurement

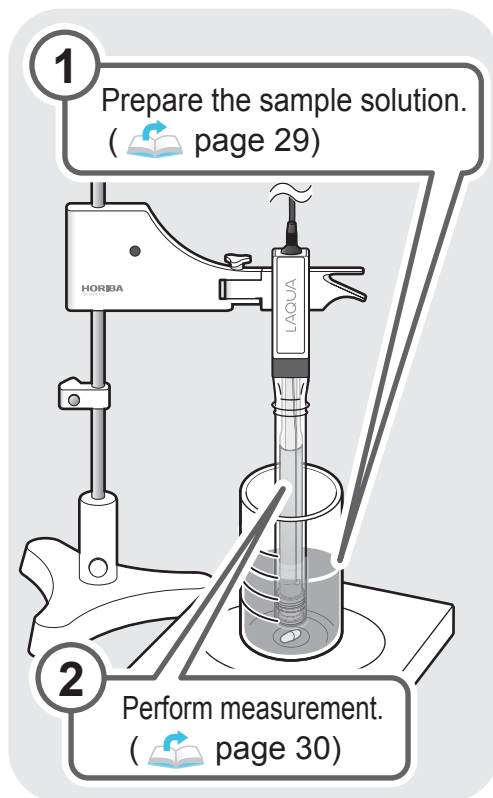

## 4 After measurement

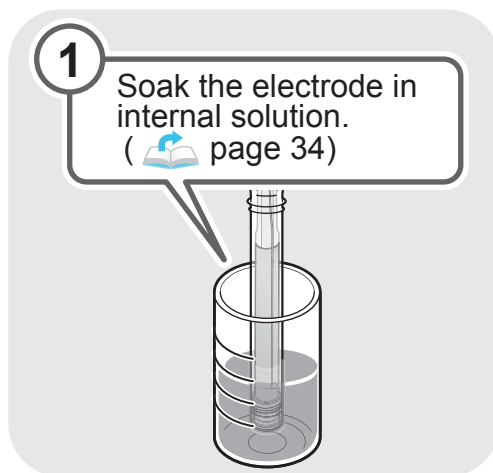

**When the electrode will not be used for one week or longer, store it as described on page 38.**

# Electrode Preparation

This chapter describes the preparation that must be performed before using the product.

<b>Assembling the electrode .....</b>	<b>8</b>
<b>Rinsing the electrode.....</b>	<b>12</b>
<b>Connecting the electrode to the meter .....</b>	<b>13</b>

# Assembling the electrode

When using the product, assemble the electrode and fill it with internal solution as described in the following procedure.

View video



Note

- Be sure to fill with internal solution before use.
- Use the internal solution included in the package or available as a consumable sold separately by HORIBA Advanced Techno. (  “Consumables” (page 66))

Items to be prepared



Main unit of electrode



Membrane cap



Internal solution



Syringe for internal solution

## 1 Remove the protective seal completely.

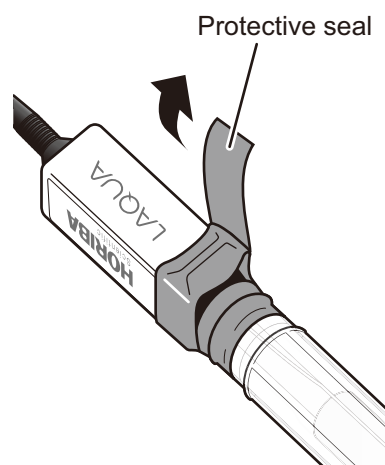

Tip

When disposing of the protective seal, follow the local rules and regulations.

## 2 Remove the protective cap.

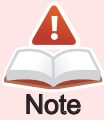
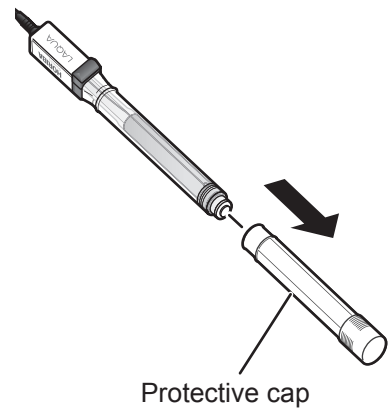

Note

Take care to ensure that the internal solution in the protective cap does not come out while removing.



Tip

When disposing of the standard solution in the protective cap, follow the local rules and regulations.

## 3 Wipe off the moisture.

Wipe off the moisture using soft and clean lint-free paper or cloth.

## 4 Fill the internal solution inside until it reaches around 1 mm height inside the membrane cap.

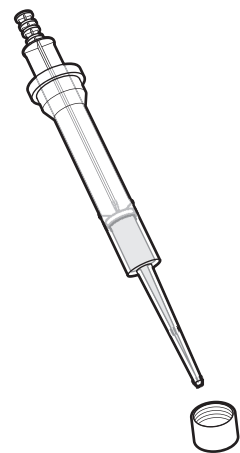

**5** Firmly attach the membrane cap by turning it clockwise.

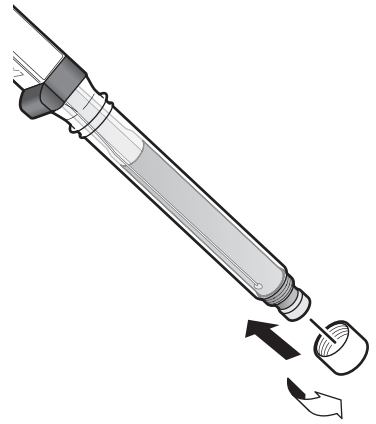

**6** Open the rubber stopper of the internal solution fill port.

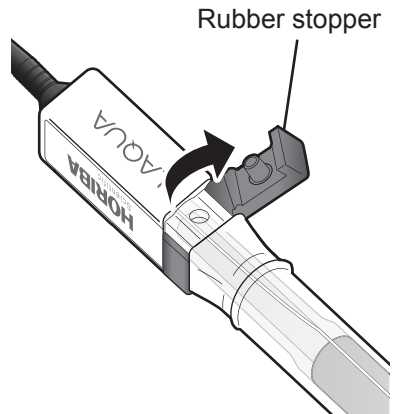

**7** Fill the internal solution with the syringe until it comes up to the line shown in the figure with arrow.

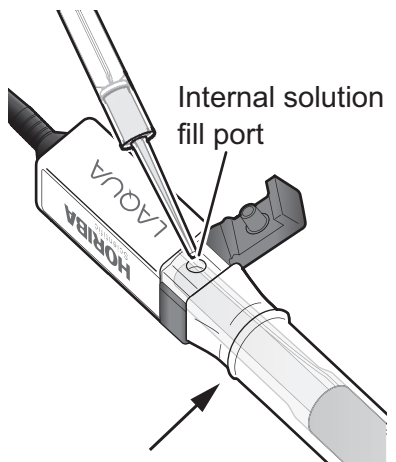

## 8 Close the rubber stopper of the internal solution fill port.

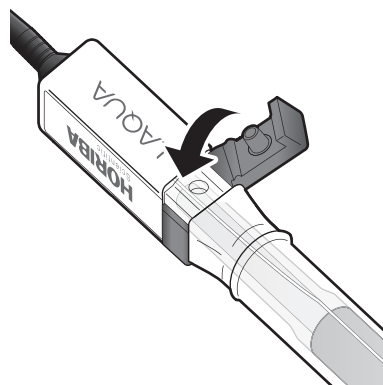

Note

- Before use, leave the membrane cap attached on the electrode soaked in the beaker filled with the internal solution for 15 minutes or longer. (  "Conditioning of the electrode" (page 21))
- Take sufficient care to ensure that the glass electrode for pH measurement and membrane cap do not get scratched. If scratched, it may result in shortening of the lifespan.

# Rinsing the electrode

Make sure that no dirt and other foreign matters have adhered to the electrode before measurement. If dirt and other foreign matters have adhered to the electrode, rinse the electrode as described in the following procedure.

View video



## 1 Rinse the electrode with pure water.

Make sure that the membrane part has been well rinsed with pure water.

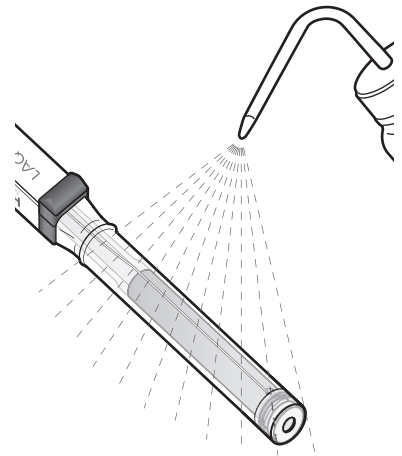

## 2 Wipe off the moisture.

Wipe off the moisture using soft and clean lint-free paper or cloth.

## 3 Make sure that there are no dirt adhered to the area around the membrane.

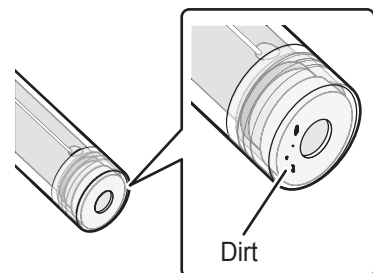

Note

If dirt is adhered, the measurement may not be performed accurately. Rinse the electrode with pure water again.



# Connecting the electrode to the meter

Connect the electrode to the meter.

For details on the connector of the meter to which the electrode will be connected, refer to the instruction manual of the meter.

View video



## 1 Connect the electrode connector to the meter.

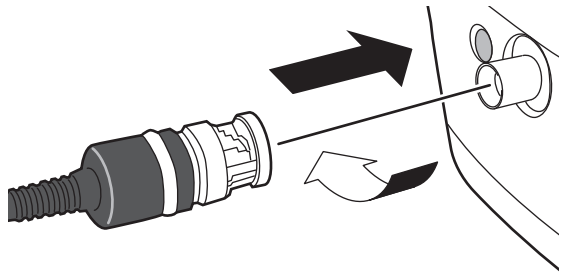

When disconnecting the electrode from the meter, disconnect it in the opposite direction from step 1.

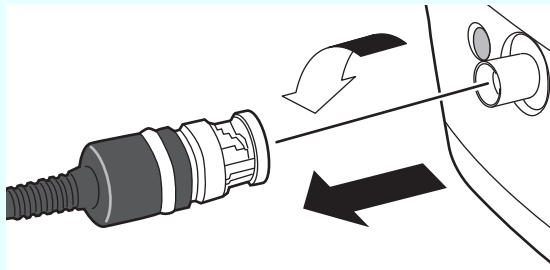

# Memo

# Calibration

This chapter describes calibration.

<b>Standard solutions.....</b>	<b>16</b>
<b>Calibration operation .....</b>	<b>17</b>

# Standard solutions

The following standard solutions are used for calibration and measurement.

- **1000 mg/L  $\text{NH}_4^+$  standard solution**  
Use the standard solution included in the package or available as consumables by HORIBA Advanced Techno.
- **100 mg/L  $\text{NH}_4^+$  standard solution**  
Use the standard solution included in the package or available as consumables by HORIBA Advanced Techno.
- **10 mg/L  $\text{NH}_4^+$  standard solution**  
Prepare this by pouring 50 mL of the 100 mg/L  $\text{NH}_4^+$  standard solution into a 500 mL volumetric flask and filling up to 500 mL with pure water.



# Calibration operation

Measure standard solutions in ascending order of ion concentration to create calibration curves in the meter (  “Ammonia electrodes” (page 54)).  
Perform calibration once every day or before measurement as appropriate.

## Before operation



Note

- Be sure to fill with internal solution and rinse the electrode before the calibration operation. (  “Assembling the electrode” (page 8), “Rinsing the electrode” (page 12))
- Perform conditioning in the following cases:
  - Before the first use
  - Before use after storage for one week or longer
  - If the electrode is less responsive
  - After the replacement of the membrane cap (  Note on page 21)

Items to be prepared



Standard solutions



pH-adjusting ionic strength adjuster\*



Syringe for adjusting pH

- \* : Prepare 5 mol/L aqueous solution of sodium hydroxide, or use the pH-adjusting ionic strength adjuster (referred to as pH-adjusting ISA in the rest of this document) available as consumables. (  “Consumables” (page 41))

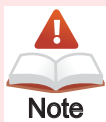

Note

- Prepare at least two types of standard solution with different concentrations.
- Always use new standard solution for calibration.
- After the standard solutions (50 mL) included in the package is used up, use the standard solution (500 mL) available as consumables.



## 1 Set the meter as shown below.

Set the valence as shown in the table on the right.

Setting item	Setting value
Valence	-1



Note

**OH<sup>-</sup> concentration is actually measured by the electrode after ammonium ion is converted to OH<sup>-</sup>. That is why the valence is set to -1 although the valence of the ammonium ion is +1. (  “Ammonia electrodes” (page 54))**

## 2 Prepare the standard solutions.

Prepare the two types of standard solution to create ammonium ion concentration ratio 1:10.

For example, if the sample solution concentration is 250 mg/L, prepare standard solutions of 100 mg/L and 1000 mg/L. This case is used as an example in the following steps.



Note

**Always use new standard solution for calibration.**

### 3 Prepare the first solution for calibration.

- (1) Put 50 mL of 100 mg/L standard solution into a 100 mL beaker.
- (2) Add 1 mL of pH-adjusting ISA.
- (3) Stir the solution slowly with a magnetic stirrer.

(1) 100 mg/L standard solution

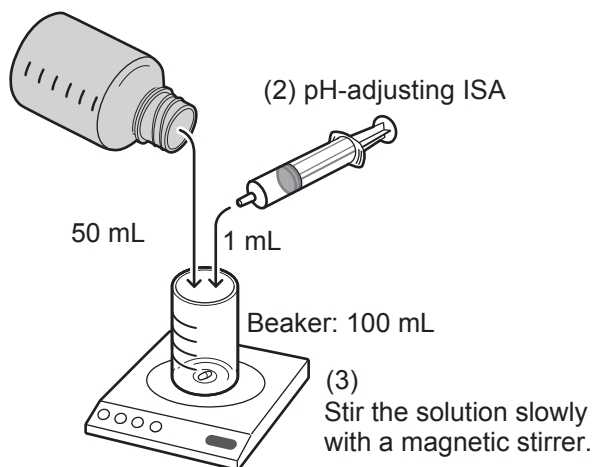

Note

It is best to control the stirring speed so that the stir bar will rotate 3 or 4 turns per second.

If swirling occurs on the surface, the stirring speed is too fast. Reduce the speed to a level where swirling does not occur.



Note

#### Additive amount of pH-adjusting ISA

In the case using different volume from the example, note that the volume ratio shall be the standard solution: the pH-adjusting ISA = 50:1.

## 4 Prepare the second solution for calibration.

- (1) Put 50 mL of 1000 mg/L standard solution into a 100 mL beaker.
- (2) Add 1 mL of pH-adjusting ISA.
- (3) Stir the solution slowly with a magnetic stirrer.

(1) 1000 mg/L standard solution

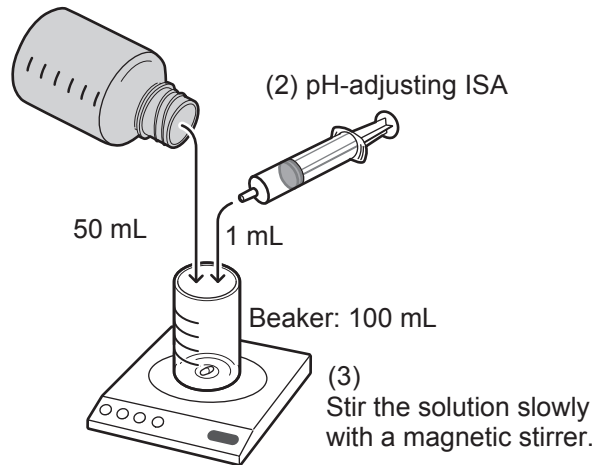

## 5 Rinse the electrode with pure water.

Make sure that the membrane part has been well rinsed with pure water.

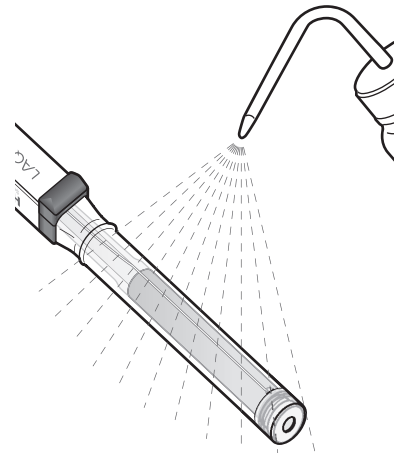

## 6 Wipe off the moisture.

Wipe off the moisture using soft and clean lint-free paper or cloth.



## Conditioning of the electrode

Soaking the electrode in an internal solution is called conditioning. In the following cases, perform the conditioning for 15 minutes or longer before calibration.



Note

- Before the first use
- Before use after storage for one week or longer
- After the replacement of the membrane cap

If the electrode is less responsive, perform conditioning for 2 hours or longer (conditioning for 12 hours is recommended).

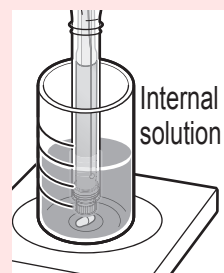

## 7 Soak the electrode in the first solution for calibration prepared in step 3.

Soak the membrane cap fully into the solution for calibration.

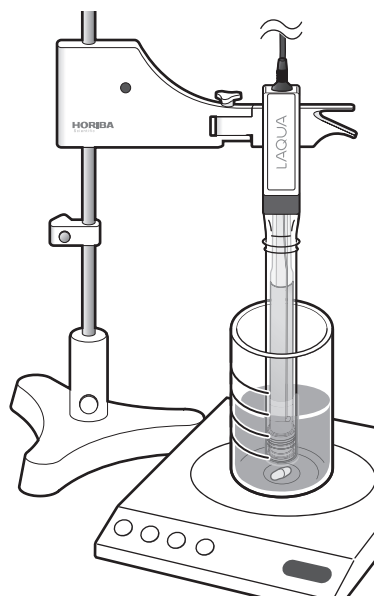

Note

Do not touch the stir bar with the electrode. It may damage the electrode.



Tip

It is recommended to place the electrode in the electrode stand.

- 8** Shake the electrode to remove any air bubbles remaining on the membrane.

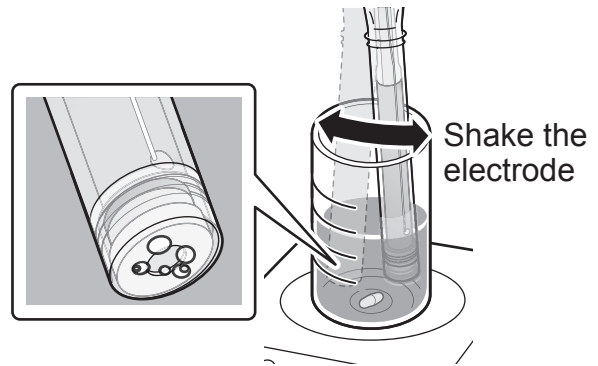

Note

- If air bubbles remain on the membrane, it may result in inaccurate measurement.
- Do not hit the beaker with the electrode. It may result in inaccurate measuring.

View video



- 9** Perform the first calibration.

Wait for a stable reading and perform the first calibration as described in the Meter Instruction Manual.

- 10** When the first calibration is finished, take out the electrode from the solution for calibration.

## 11 Rinse the electrode with pure water.

Make sure that the membrane part has been well rinsed with pure water.

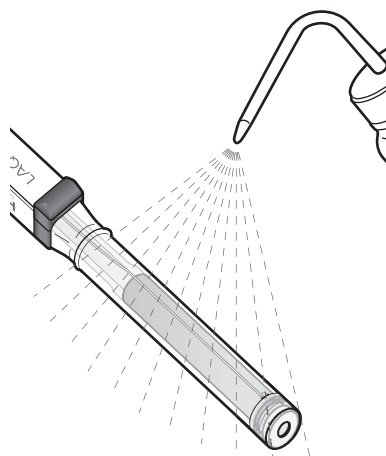

Electrode Preparation

## 12 Wipe off the moisture.

Wipe off the moisture using soft and clean lint-free paper or cloth.

## 13 Soak the electrode in the second solution for calibration prepared in step 4.

Soak the membrane cap fully into the solution for calibration.

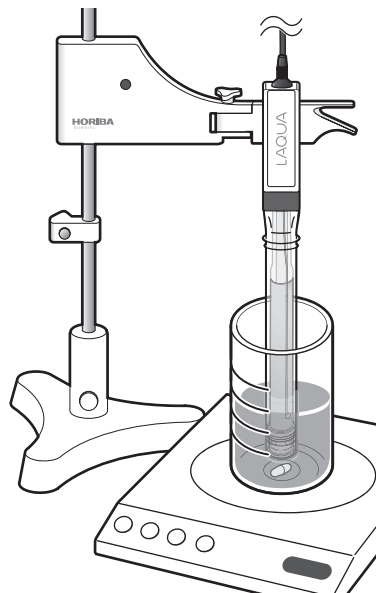

Calibration

Measurement



Note

**Do not touch the stir bar with the electrode. It may damage the electrode.**



Tip

It is recommended to place the electrode in the electrode stand.

After Measurement

## 14 Shake the electrode to remove any air bubbles out of the membrane.

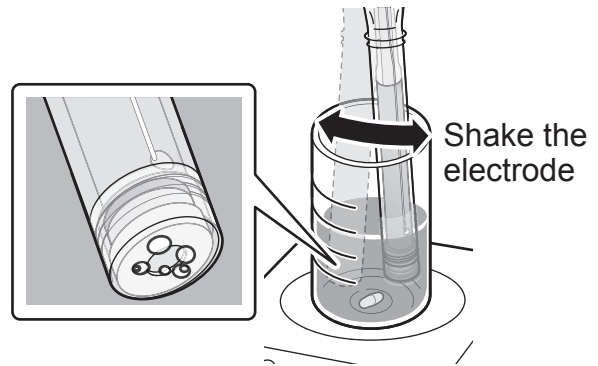

Note

- If air bubbles remain on the membrane, it may result in inaccurate measurement.
- Do not hit the beaker with the electrode. It may result in inaccurate measuring.

View video



## 15 Perform the second calibration.

Wait for a stable reading and perform the second calibration as described in the Meter Instruction Manual.

When the second calibration is finished, the slope (%) of the electrode is displayed.

## 16 Check the slope (%) on the meter.

For details on how to check the slope (%), refer to the Meter Instruction Manual.

Check that slope is at least 80%.

If the slope is less than 80%, the measurement may not be performed accurately.

The possible causes of calibration failure are:

- Membrane is dirty or broken
- Change in the internal solution concentration
- Change in composition and concentration of the standard solution
- Bubble inside the membrane cap



Note

Refer to “When accurate measurement is not possible” (  page 48) to resolve the cause and perform the calibration again.

**17** When the second calibration is finished, take out the electrode from the solution for calibration.

**18** Rinse the electrode with pure water.

Make sure that the membrane part has been well rinsed with pure water.

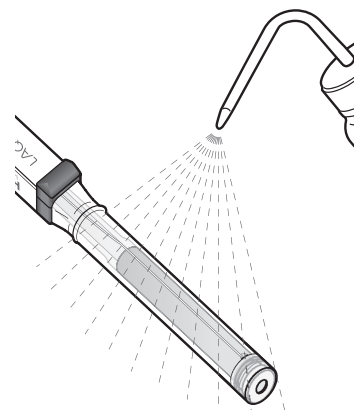

**19** Wipe off the moisture.

Wipe off the moisture using soft and clean lint-free paper or cloth.



Tip

When disposing of the standard solution, and paper or cloth soaked in the standard solution, follow the local rules and regulations.

# Memo

# Measurement

This chapter describes measurement.

---

<b>Requirements for sample and standard solutions .....</b>	<b>28</b>
<b>Measurement hints .....</b>	<b>29</b>
<b>Measurement units .....</b>	<b>30</b>
<b>Measurement operation.....</b>	<b>31</b>

# Requirements for sample and standard solutions

The requirements for sample solutions and standard solutions are as follows:

- The temperatures of sample solution and standard solution shall be kept at 50°C or less. Exceeding 50°C may cause electrode deterioration.
- The standard solution in calibration and the sample solution in measurement shall have almost the same temperature. Match the temperature as close as possible by, for example, using a thermostatic bath. The temperature difference may cause measurement error.
- The pH-adjusting ISA shall be added into the sample solution (  Step1 of " Measurement operation" (page 31)). If not, the measurement can not be performed accurately.



# Measurement hints

- A gradual rise in solution temperature due to the magnetic stirrer generating heat may cause an apparent potential drift.  
When it happens, reduce the influence of the temperature changes by covering the magnetic stirrer with heat insulation such as polystyrene foam or using a thermostatic bath.
- Soak the membrane cap fully into the sample solution during measurement.
- If the pH of the sample solution has exceeded the measurable pH range, accurate measurement may not be possible (  “Impact of pH” (page 58)).

# Measurement units

This product can measure ammonium ion concentration in three types of units. Refer to the following table to convert the measurement unit.

Table 1 Ammonium ion concentration measurement unit conversion table

Ammonium ion concentration [mol/L]	Ammonium ion concentration [mg/L]	Ammonia nitrogen concentration [mg/L]
$1 \times 10^{-4}$	1.804	1.4
$1 \times 10^{-3}$	18.04	14
$1 \times 10^{-2}$	180.4	140
$1 \times 10^{-1}$	1804	1400

# Measurement operation

## Before operation



Note

- The calibration characteristics vary depending on the temperature. The standard solution in calibration and the sample solution in measurement shall have almost the same temperature. Match the temperature as close as possible by, for example, using a thermostatic bath. The temperature difference may cause measurement errors.
- Measure the sample solution only once after adding the pH-adjusting ISA.  
Also, perform the measurement immediately after adding the pH-adjusting ISA.  
The ammonia in the stirred sample solution gets diffused as time passes, causing the measurement result to vary.

Items to be prepared



Syringe for adjusting pH



pH-adjusting ISA\*

- \* : Prepare 5 mol/L aqueous solution of sodium hydroxide, or purchase the pH-adjusting ISA available as consumables.  
(  "Consumables" (page 66))

# 1 Prepare the sample solution.

In this section, the case using sample solution (250 mg/L) is used as an example in the following steps.

(1) Put 50 mL of sample solution (concentration of 250 mg/L) in a 100 mL beaker.

(2) pH-adjusting ISA: 1 mL

(2) Add 1 mL of pH-adjusting ISA.

(3) Stir the solution slowly with a magnetic stirrer.

(1) Sample solution (250 mg/L): 50 mL  
Beaker: 100 mL

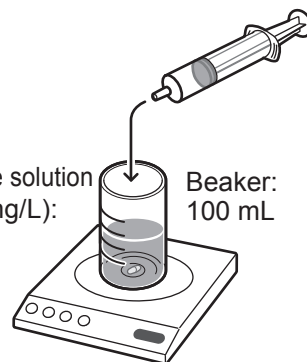

(3) Stir the solution slowly with a magnetic stirrer.



Note

**It is best to control the stirring speed so that the stir bar will rotate 3 or 4 turns per second. If swirling occurs on the surface, the stirring speed is too fast. Reduce the speed to a level where swirling does not occur.**



Note

## About the amount of pH-adjusting ISA

**In the case using different volume from the example, note that the volume ratio shall be the sample solution: the pH-adjusting ISA = 50:1**

# 2 Rinse the electrode with pure water.

Make sure that the membrane part has been well rinsed with pure water.

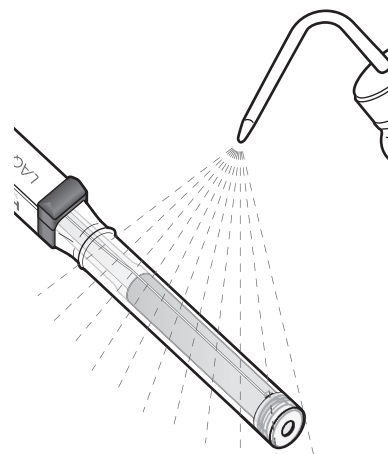

### 3 Wipe off the moisture.

Wipe off the moisture using soft and clean lint-free paper or cloth.

### 4 Soak the electrode in the sample solution prepared in step 1.

Soak the membrane cap fully into the sample solution.

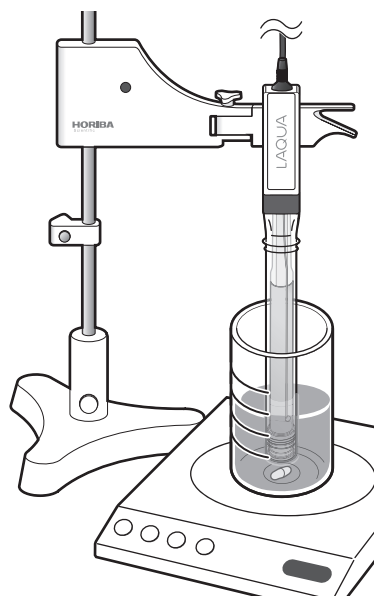

Note

**Do not touch the stir bar with the electrode. It may damage the electrode.**



Tip

It is recommended to place the electrode in the electrode stand.

### 5 Shake the electrode to remove any air bubbles remaining on the membrane.

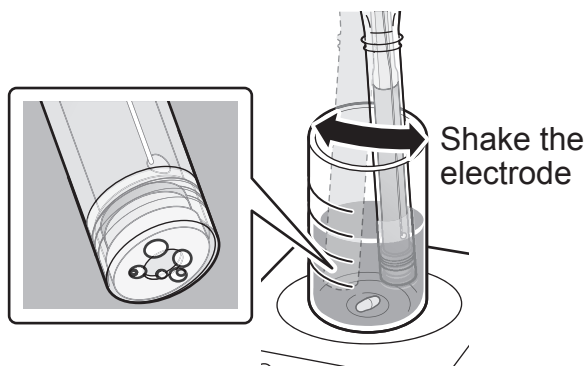

Electrode Preparation

Calibration

Measurement

After Measurement



Note

- If air bubbles remain on the membrane, it may result in inaccurate measurement.
- Do not hit the beaker with the electrode. It may result in inaccurate measuring.

View video



## 6 Perform the measurement.

Wait for a stable reading and measure the ion concentration as described in the Meter Instruction Manual.

## 7 When the measurement of the ion concentration is finished, take out the electrode from the sample solution.

## 8 Rinse the electrode with pure water.

Make sure that the membrane part has been well rinsed with pure water.

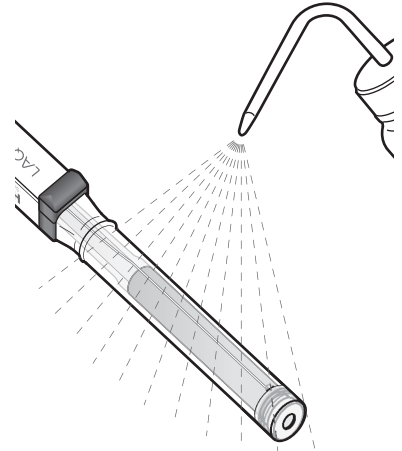

## 9 Wipe off the moisture.

Wipe off the moisture using soft and clean lint-free paper or cloth.

# After Measurement

This chapter describes how to keep the electrode after measurement.

---

**How to keep the electrode..... 36**

# How to keep the electrode

Make sure the electrode used for measurement is kept soaked in the internal solution until the next measurement is started.

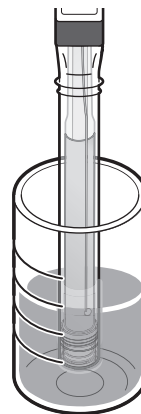

Note

**When the electrode will not be used for one week or longer, store it as described on page 38.**



# Maintenance

This chapter describes the storage procedure of the electrode as well as the lifespan and replacement procedure of each part.

---

## **Storage ..... 38**

Main unit of electrode .....38

---

## **Consumables ..... 41**

Consumables and replacement periods .....41

---

## **Membrane cap replacement ..... 43**

# Storage

When the electrode will not be used for one week or longer, store it as described in the following procedure.

## ■ Main unit of electrode

---

- 1** Turn the electrode with the membrane cap upward and remove the membrane cap by turning it counterclockwise.

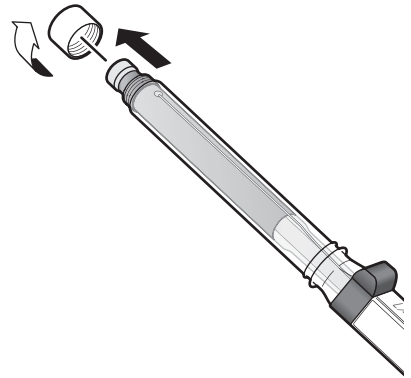

- 2** Drain the internal solution by turning the electrode with the membrane cap downward and opening the rubber stopper of the internal solution fill port.

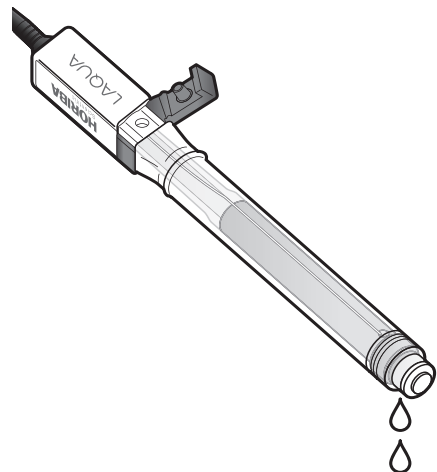

- 3** Close the rubber stopper of the internal solution fill port.

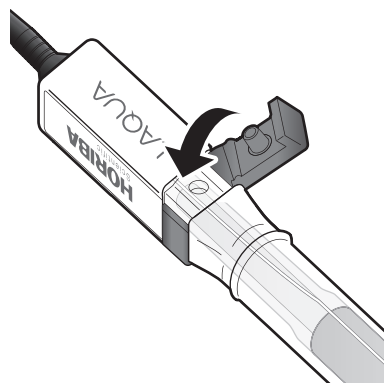

- 4** Rinse the membrane cap and the electrode with pure water.

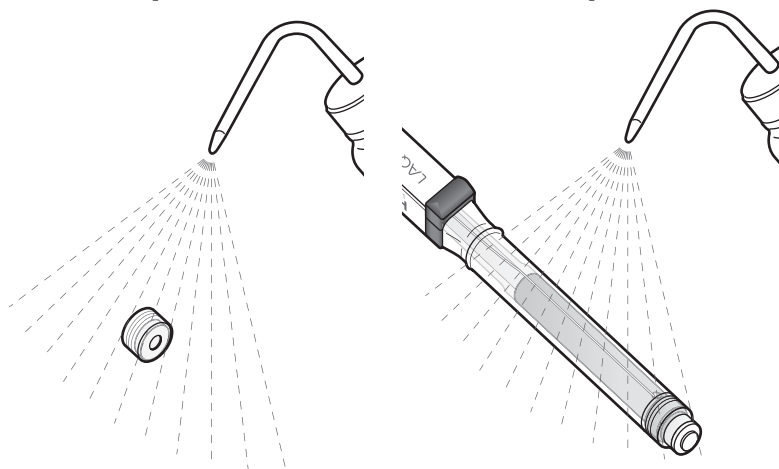

## 5 Wipe off the moisture.

Wipe off the moisture using soft and clean lint-free paper or cloth.

## 6 Make sure that there are no dirt or crystals of internal solution adhered to the area around the glass electrode for pH measurement and support pipe.

If dirt remains, repeat steps 4 and 5.

## 7 Fill 6 mL of the internal solution with the syringe into the protective cap.

## 8 Attach the protective cap.

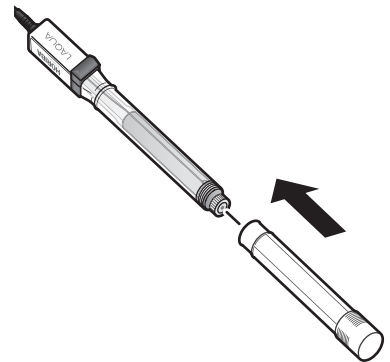

Note

- Store the glass electrode for pH measurement and the membrane cap safely without any damage.
- Do not get water and foreign matters inside of the protective cap when attach it to the electrode. It may shorten the lifespan.
- When you will use the electrode again, perform operation from filling with internal solution (  “Assembling the electrode” (page 8)).

# Consumables

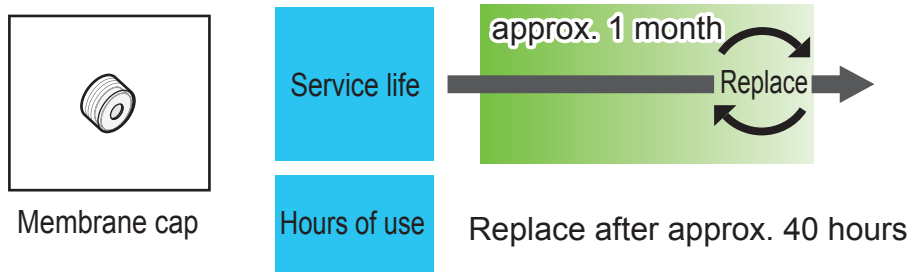

## ■ Consumables and replacement periods

The consumables that need to be replaced and the replacement periods are as follows. Replace each part at the appropriate timing to ensure accurate measurement.



Replace consumables at the period whichever occurs first; approx. one month after purchase or after approx. 40 hours of use depending on sample solution, measurement frequency, and measurement environment.

### • Membrane cap replacement guide

When the slope displayed on the meter is less than 80% during calibration, clean the electrode (  “How to keep the electrode” (page 36)) and perform the calibration operation again. If the slope is still less than 80% after that, replace the membrane cap. If the response time is getting longer, also replace the membrane cap (  “Response time” (page 60)).



Tip

- The main unit of the electrode and ion electrode tip are not repairable parts.

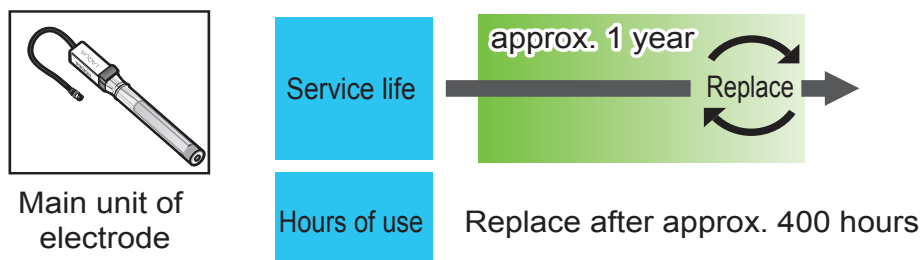

Replace consumables at the period whichever occurs first; approx. one year after purchase or after approx. 400 hours of use, depending on sample solution, measurement frequency, and measurement environment.



Note

**Single piece of the electrode main unit is not available for sale.**

**When replacing the main unit of electrode, purchase the ammonia electrode including the membrane cap (3200698386).**

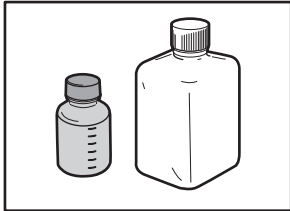

Standard solution

Use this up before the expiration date displayed on the bottle.

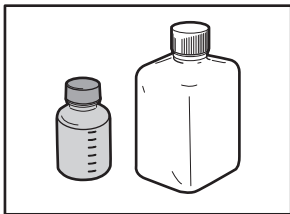

Internal solution

Use this up before the expiration date displayed on the bottle.



pH-adjusting ISA

Use this up before the expiration date displayed on the bottle.

## ■ Membrane cap replacement

Replace the membrane cap as described in the following procedure.

- 1** Turn the electrode with the old membrane cap upward and remove the old membrane cap by turning it counterclockwise.

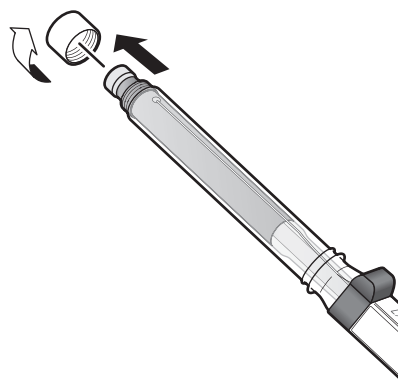

Tip

When disposing of the old membrane cap, follow the local rules and regulations.

- 2** Drain the internal solution by turning the electrode with the membrane cap downward and opening the rubber stopper of the internal solution fill port.

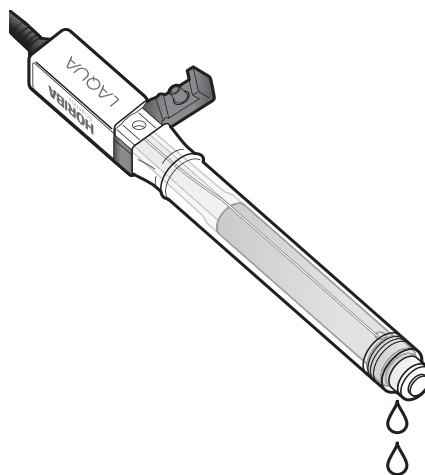

- 3** Fill the internal solution inside until it reaches around 1 mm height inside the membrane cap.

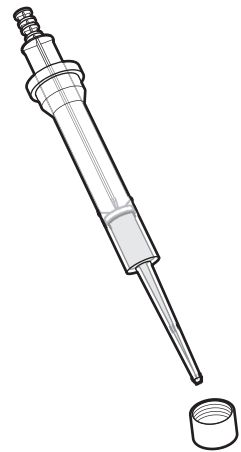

- 4** Firmly attach the membrane cap by turning it clockwise.

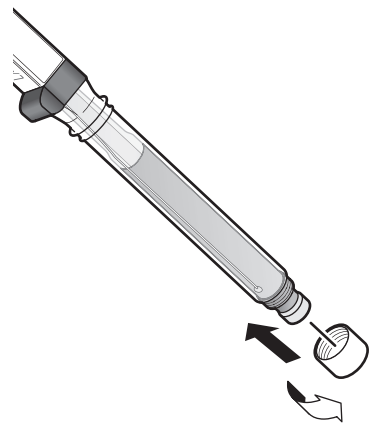

- 5** Fill the internal solution with the syringe until it comes up to the line shown in the figure with arrow.

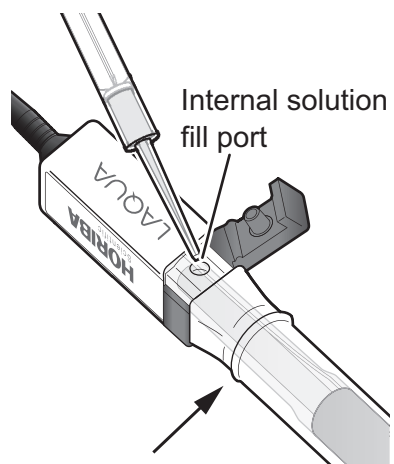



## 6 Close the rubber stopper of the internal solution fill port.

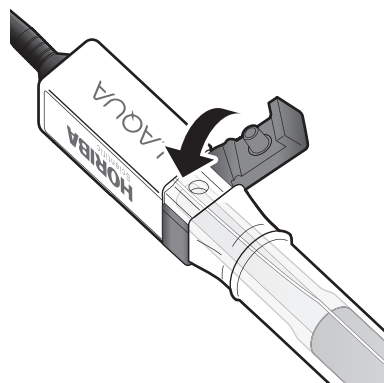

Note

- Before use, leave the membrane cap attached on the electrode soaked in the beaker filled with the internal solution for 15 minutes or longer. (  "Conditioning of the electrode" (page 21))
- Take sufficient care to ensure that the glass electrode for pH measurement and membrane cap do not get scratched. If scratched, it may result in shortening of the lifespan.

# Memo

# Troubleshooting

This chapter describes the measures to take when accurate measurement is not possible.



---







<b>When accurate measurement is not possible.....</b>	<b>48</b>
---	-----------







# When accurate measurement is not possible





When accurate measurement is not possible, check the following.





Table 2 Check list

Check item	Solution	View in video
Are the temperatures of the standard solution and sample solution the same?	The standard solution in calibration and the sample solution in measurement shall have almost the same temperature. Match the temperature as close as possible by, for example, using a thermostatic bath. The temperature difference may cause measurement errors. (  “Requirements for sample and standard solutions” (page 28))	—
Is the stirring solution speed appropriate?	It is best to control the stirring speed so that the stir bar will rotate 3 or 4 turns per second. If swirling occurs on the surface, the stirring speed is too fast. Reduce the speed to a level where swirling does not occur. (  “Impact of stirring” (page 59))	

Check item	Solution	View in video
Is the temperature of the solution being stirred rising?	A gradual rise in solution temperature due to the magnetic stirrer generating heat may cause an apparent potential drift. Reduce the influence of the temperature changes by covering the magnetic stirrer with heat insulation such as polystyrene foam or using a thermostatic bath. (  “Measurement hints” (page 29))	—
Is measurement being performed while air bubbles are on the membrane?	Shake the electrode to remove any air bubbles remaining on the membrane. If air bubbles remain on the membrane, it may result in inaccurate measurement. (  Note on page 34)	
Is a solution at a temperature outside the measurement temperature range being measured?	Adjust the temperature of the solution so that it is within the measurement temperature range before measurement. If not, it may cause measurement errors as well as damages or deterioration to the electrode. (  “Specifications” (page 64))	—
Is the electrode dirty?	Rinse the electrode. A dirty electrode will cause measurement errors or a decrease in the response rate during calibration. (  “Rinsing the electrode” (page 12))	

Check item	Solution	View in video
Has the internal solution been replaced?	Replace the internal solution before each measurement. If not, the internal solution concentration will change and it will cause measurement error.	 
Is there a sufficient amount of internal solution?	Make sure that the surface of the solution is just below the internal solution fill port. If it is not sufficient, fill the internal solution sufficiently. (  Step 7 of “Assembling the electrode” (page 10))	
Was the standard solution made using pure water?	Prepare the standard solution using pure water. Preparing the standard solution with water other than pure water will cause measurement errors. (  “Standard solutions” (page 16))	—
Is calibration performed before each measurement?	Perform calibration before each measurement. (  “Calibration operation” (page 17))	—
Is the electrode temperature is same as measurement place?	Wait until the temperature of the electrode becomes the temperature of that place before using the electrode.	—

Check item	Solution	View in video
Has the standard solution expired?	<p>If the standard solution has expired, replace it with a new one. Use up the standard solution within approximately 3 months after opening the bottle. Do not return the standard solution to its bottle once it has come out of the bottle.</p> <p>(  “Consumables” (page 41))</p>	—
Has conditioning of the membrane being performed?	<p>Before performing calibration, soak the electrode with the membrane in the internal solution for 15 minutes or longer. If not, it may cause measurement errors or decrease in the response rate during calibration.</p> <p>(  Note on page 21)</p>	—
Is there any perforation in the membrane?	<p>Check that when a 1 mL of sodium hydroxide is added to 50 mL of pure water, the measured value does not fluctuate by more than 60 mV. If the measured value fluctuates by more than 60 mV, there is a perforation in the membrane. Replace the membrane cap.</p> <p>(  “Membrane cap replacement” (page 43))</p>	—
Has a pH-adjusting ISA been added?	<p>Perform measurement after adding a pH-adjusting ISA in both the standard solution and sample solution.</p> <p>(  “Calibration operation” (page 17))</p> <p>(  “Measurement operation” (page 31))</p>	—

Check item	Solution	View in video
Has the membrane cap been attached properly?	Attach the membrane cap properly. If the membrane cap is loose, the standard solution or sample solution may enter inside the electrode resulting in a measurement error. (  "Assembling the electrode" (page 8))	—
Has the glass electrode for pH measurement been stored in the dry state?	If it has been stored in the dry state, it may cause measurement errors or decrease in the response rate during calibration. Perform conditioning before calibration. (  Note on page 21) If it will not be used for one week or longer, store it according to the storage procedure. (  "Storage" (page 38))	—
Are there air bubbles inside the membrane cap?	If there are air bubbles between the membrane and the pH glass ion selective membrane, it may cause measurement errors or calibration errors. Please check the assembly procedure. (  "Assembling the electrode" (page 8))	—



# Reference

This chapter describes general matters regarding ammonia electrodes.

---

## **Ammonia electrodes ..... 54**

---

## **Characteristics of ammonia electrode ..... 57**

Measurement range .....	57
Impact of pH .....	58
Impact of temperature .....	58
Impact of stirring .....	59
Impact of coexistent substances .....	60
Response time .....	60
Standard solutions .....	61

# Ammonia electrodes

The structure of the ammonia electrode is shown in Fig. 4.

The ammonia electrode is configured by a glass electrode for pH measurement, a support pipe, and a membrane cap. The tip of the glass electrode for pH measurement is made of a pH glass ion selective membrane, and the tip of the support pipe has a membrane cap provided with a membrane attached to it. The internal solution is filled between the support pipe and the glass electrode for pH measurement.

The membrane attached to the membrane cap allows only gases (including gases dissolved in aqueous solutions) to permeate through.

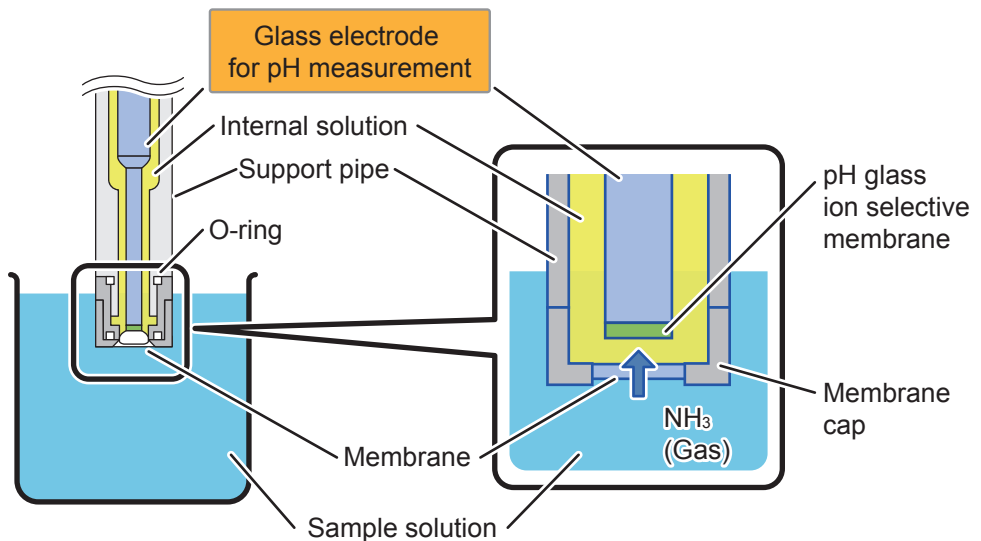

Fig. 4 Structure of ammonia electrode

The abundance ratio between the ammonium ion  $\text{NH}_4^+$  and ammonia  $\text{NH}_3$  based on the pH value is shown in Fig. 5.

It is understood that when the pH value becomes 12 or more (alkalinity), most of the ammonium ions  $\text{NH}_4^+$  convert to ammonia  $\text{NH}_3$ .

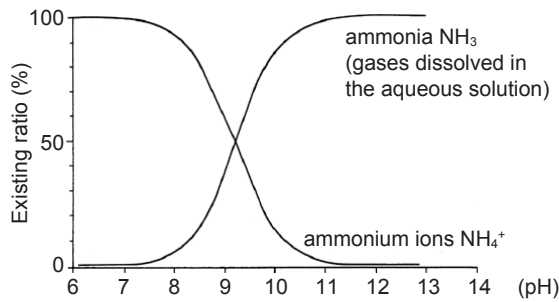

Fig. 5 Abundance ratio between ammonia  $\text{NH}_3$  and ammonium ion  $\text{NH}_4^+$

Therefore, when the pH value of the sample solution to be measured is adjusted to 12 or more, most of the ammonium ions  $\text{NH}_4^+$  in the sample solution are converted to ammonia  $\text{NH}_3$  (gases dissolved in the aqueous solution), and as a result, ammonia  $\text{NH}_3$  can permeate through the membrane.

For example, when sodium hydroxide  $\text{NaOH}$  is added to the sample solution and the pH is adjusted to 12 or more, ammonium ions  $\text{NH}_4^+$  convert to ammonia  $\text{NH}_3$  through binding with hydroxide ions  $\text{OH}^-$ .

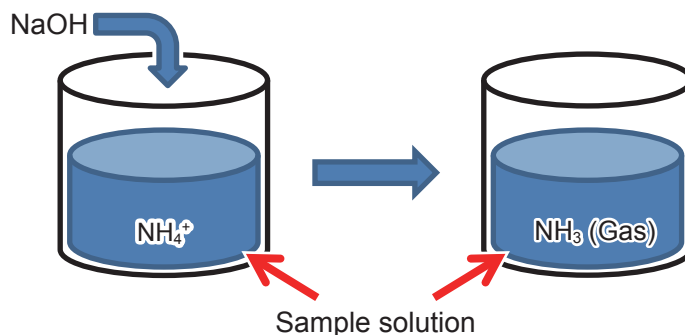
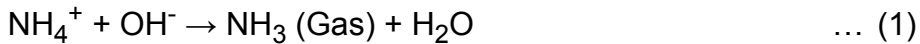
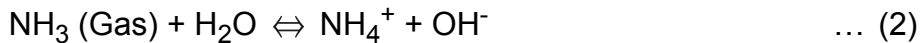

Fig. 6 Conversion from ammonium ions  $\text{NH}_4^+$  to ammonia  $\text{NH}_3$

The ammonia  $\text{NH}_3$  that has been converted to gas permeates through the membrane, and disassociates into ammonium ions  $\text{NH}_4^+$  and hydroxide ions  $\text{OH}^-$  in the internal solution.



The expression shown below can be obtained if the disassociation constant is assumed to be  $K$ .

$$\frac{[\text{NH}_4^+] [\text{OH}^-]}{[\text{NH}_3]} = K [\text{H}_2\text{O}] = K'$$

Here, the [Molecular formula] and the [Ionic formula] respectively indicate the concentration of molecules and ions. Moreover,  $[\text{H}_2\text{O}]$  is constant.

When the log of both sides is taken and the ammonia concentration  $\text{pNH}_3 = -\log [\text{NH}_3]$  and  $\text{pK}' = -\log K'$  is assumed, the expression shown below can be obtained.

$$\text{pNH}_3 = -\text{pK}' - \log [\text{NH}_4^+] - \log [\text{OH}^-] \quad \dots (3)$$

On the other hand, the disassociation constant  $K_w$  of water can be obtained by the expression shown below.

$$K_w = [\text{H}^+] [\text{OH}^-]$$

When the log of both sides is taken and  $\text{pH} = -\log [\text{H}^+]$  and  $\text{pK}_w = -\log K_w$  is assumed, the expression shown below can be obtained.

$$\log [\text{OH}^-] = \text{pH} - \text{pK}_w \quad \dots (4)$$

Thus, the following expression for determining the ammonia concentration  $\text{pNH}_3$  can be obtained from the expressions (3) and (4).

$$\begin{aligned} \text{pNH}_3 &= -\text{pH} - \log [\text{NH}_4^+] + \text{pK}'' \\ \text{where } \text{pK}'' &= -(\text{pK}_w + \text{pK}') \end{aligned} \quad \dots (5)$$

If ammonium chloride  $\text{NH}_4\text{Cl}$  is used as the internal solution, a large number of ammonium ions  $\text{NH}_4^+$  will exist in the internal solution, and therefore, the  $\log [\text{NH}_4^+]$  of the second term on the right of the expression (5) is considered to be almost constant.

Therefore, the ammonia concentration  $\text{pNH}_3$  becomes proportionate to the pH value, and if the pH value is measured, the ammonia concentration  $\text{pNH}_3$  can be determined.

Thus, the ammonium ion concentration is determined by the measured ammonia concentration because almost of the ammonium ion is converted to the ammonia.

# Characteristics of ammonia electrode

## ■ Measurement range

The range where linearity is established between the logarithm of the ion concentration and the electromotive force is called the measurement range.

In general, the range for measuring ion concentration using ammonia electrodes is a maximum of around  $1 \times 10^{-1}$  mol/L and a minimum of around  $1 \times 10^{-6}$  mol/L to  $1 \times 10^{-5}$  mol/L.

Furthermore, when lower concentration is measured where the linearity is not established, perform calibration at two points in the lower concentration range.

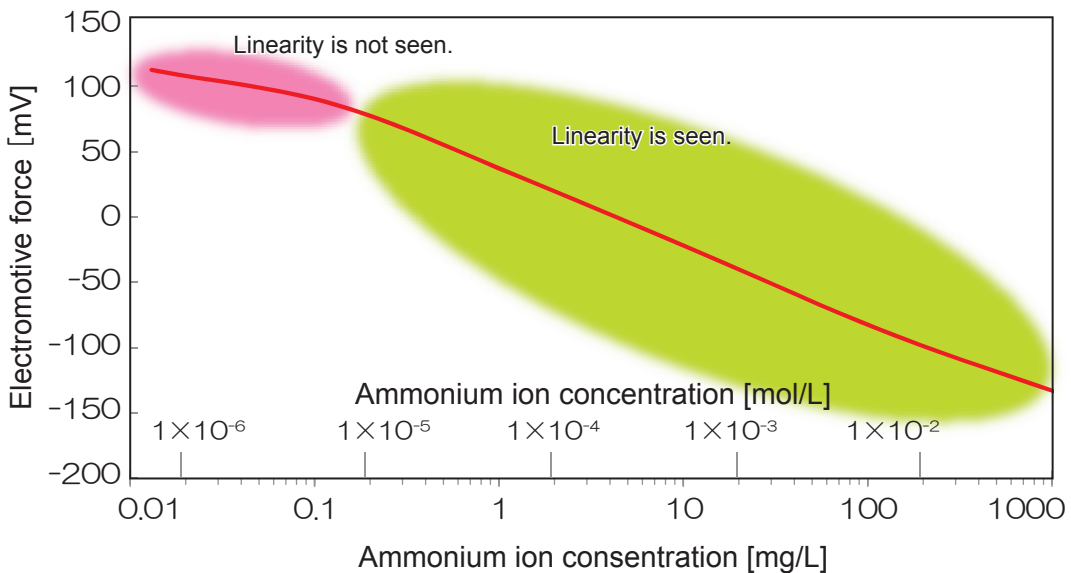

Fig. 7 Calibration curve of ammonia electrode

## ■ Impact of pH

The ammonia electrode can be used in the specified pH range. The impact of the pH may cause a decrease in the slope of the ammonia electrode, or parallel shifting of the calibration curve.

To prevent these effects, add an appropriate amount of pH-adjusting ISA to keep the pH of the solution constant in advance.

## ■ Impact of temperature

The potential gradient measured by the ion electrode method\* is impacted by the temperature of the sample solution in accordance with the Nernst equation\*\*. The higher the temperature is, the larger the potential gradient is. The lower the temperature is, the smaller the potential gradient is.

The standard solution in calibration and the sample solution in measurement shall have almost the same temperature. Match the temperature as close as possible.

- \* : This is the method to measure the ion concentration by measuring potential difference between ion selective electrode and reference electrode soaked in the sample solution.
- \*\* : This is the equation which shows the logarithmic proportional relationship between the potential gradient and the ion concentration (activity) in a sample solution.

Table 3 Relationship between temperature of ion selective electrode and theoretical slope

Unit: mV/decade (mV/concentration change of 10 times)

		Temperature (°C)						
		0	10	20	25	30	40	50
Theoretical slope	Monovalent ions	54.20	56.18	58.16	59.16	60.15	62.13	64.11
	Divalent ions	27.10	28.09	29.08	29.58	30.07	31.07	32.06

The optimal way to minimize the impact of temperature on the measurement of the ammonium ion concentration is to reduce the difference between the temperature of the standard solution in calibration and the temperature of the sample solution in measurement to  $\pm 1^\circ\text{C}$ . The following table shows the change in the theoretical slope of the ammonia electrode depending on the temperature of the ammonia electrode.

Table 4 Relationship between temperature of ammonia electrode and theoretical slope

Temperature [°C]	Theoretical slope of ammonia electrode [mV/decade] (mV/concentration change of 10 times)
0	54.20
10	56.18
20	58.16
25	59.16
30	60.15
40	62.13
50	64.11

If the temperature of the sample solution in measurement differs from the temperature of the standard solution in calibration, perform calibration again.

When the electrode is moved to a place that has a different temperature, wait until the temperature of the electrode becomes same as the temperature of that place before using the electrode.

## ■ Impact of stirring

The impacts on the measurement of the electromotive force by stirring the sample solution inappropriately are, for example, slow response, inability to measure the low concentration solution, and the change of the electrode potential.

It is best to control the stirring speed so that the stir bar will rotate 3 or 4 turns per second.

If swirling occurs on the surface, the stirring speed is too fast. Reduce the speed to a level where swirling does not occur.

## ■ Impact of coexistent substances

---

Because ammonia electrode determines ammonia concentration by measuring pH change in inner solution caused by ammonia gas permeating through the membrane, presence of acidic or basic gas other than ammonia causes error. Such acidic gas as  $\text{H}_2\text{S}$  or  $\text{CO}_2$ , however, is ionized in alkali region and does not exist as acidic gas, so that no problem is created as long as the sample is measured in alkaline state.

On the other hand, the presence of volatile amine, gives error on indication because it generates basic gas under alkaline state.

In any sample in which organic solvent such as acetone and alcohol is included, the membrane is damaged or permeated by the organic solvent so that indication becomes unstable to inhibit measurement.

## ■ Response time

---

The response times of ammonia electrodes differ depending on factors such as ammonium ion concentration, temperature, and the stirring speed. In general, the response time tends to be shorter when the ion concentration is high and longer when the ion concentration is low.

Furthermore, the response time may become shorter when a high concentration solution is measured after measuring a low concentration solution, while the opposite case may cause the response time to become longer.

The time required to reach a reading value that is 95% stabilized is within one minute in the case of a standard solution with a concentration ranging from 10 mg/L to 100 mg/L.



## ■ Standard solutions

---

### ◆ Selecting standard solutions

- Perform calibration using standard solutions of 100 mg/L and 1000 mg/L. Approximate concentrations can be measured.
- For more accurate measurements, prepare standard solutions which have the following concentration relationship for calibration.

Standard solution with low concentration < Sample solution < Standard solution with high concentration

In this case, prepare two standard solutions so that the concentration of one of the two standard solutions is approximately 1/10 of that of the other standard solution.

### ◆ Temperatures of the standard solution and sample solution

When taking measurements, match the temperature of the standard solution in calibration and the temperature of the sample solution in measurement.

This reduces the errors in the ion concentration measurement due to the electromotive force changes caused by the temperature changes of the glass electrode for pH measurement.

Measurement errors become larger as the difference between the temperatures of the standard solution and sample solution becomes larger.

### ◆ Handling of standard solutions after use

Do not return a standard solution to its original container after it has been used once.

The composition and concentration of the standard solution will have changed, which will cause measurement errors because accurate calibration will not be possible.

### ◆ Storing standard solutions

Put the standard solution in a container that can be hermetically sealed, seal the container hermetically, and store it in a cool and dark place. If standard solution is stored in a state in which it is open to the atmosphere, the concentration will change due to, for example, evaporation and the mixing of impurities.

# Memo

# Material

This chapter describes the specifications, external dimensions, and consumables of the product.

---

**Specifications ..... 64**

---

**External dimensions ..... 65**

---

**Consumables ..... 66**

# Specifications

The following table shows the specifications of the product.

Table 5 Specifications of ammonia electrode

Item	Description
Operating temperature range	0°C to 50°C
Internal electrode	Ag/AgCl (silver/silver chloride) electrode
Internal solution	0.1 mol/L NH <sub>4</sub> Cl
Wetted part (part contacting sample solution) material	PTFE, PVC, PSU
Measurement range	0.01 mg/L to 18000 mg/L as NH <sub>4</sub> <sup>+</sup> (5×10 <sup>-7</sup> mol/L to 1 mol/L as NH <sub>4</sub> <sup>+</sup> )
Measurement accuracy (*1)	±2%
pH range (*2)	pH 12 or more (5×10 <sup>-7</sup> mol/L to 1 mol/L as NH <sub>4</sub> <sup>+</sup> )
Potential gradient (*3)	-54 mV/decade to -62 mV/decade
Insulation resistance	5×10 <sup>10</sup> Ω
Portion to be placed	From membrane to internal solution fill port
Connector and cable length	BNC, 1 m

\*1: The measurement accuracy is the difference between the measured value and the assigned value of the 100 mg/L standard solution after the two points calibration using the 10 mg/L and the 100 mg/L standard solutions. The temperature in the calibration and in the measurement is 25°C

\*2: The ion concentration value enclosed in ( ) is the measurable pH tolerance range.

However, the tolerance range differs depending on the ion concentration.

\*3: This is the electrode potential gradient in the calibration using the 10 mg/L and the 100 mg/L standard solutions at 25°C.

# External dimensions

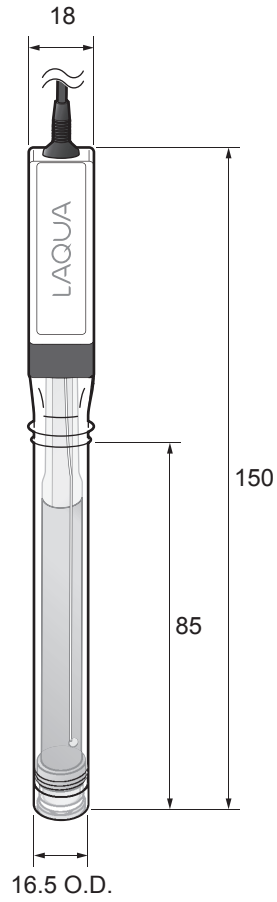

[Unit: mm]

# Consumables

Consumables can be purchased from your nearest local representative by notifying the product name and the part number.

Table 6 Consumables

Product name	Model	Specifications	Part number
Ammonia electrode	5002S -10C	-	3200698386
Ammonia electrode membrane cap	-	Membrane cap (3 units)	3200705774
1000 mg/L ammonium ion standard solution	500 -NH4 -SH	500 mL	3200697171
100 mg/L ammonium ion standard solution	500 -NH4 -SL	500 mL	3200697172
Ammonia electrode inner filling solution (Internal solution)	500 -NH3 -IFS	500 mL	3200697173
Ionic strength adjuster for Ammonia electrode (pH-adjusting ISA)	500 -NH3 -ISA	500 mL	3200697174

# **HORIBA**Advanced Techno

31, Miyanonishi-cho, Kisshoin Minami-ku, Kyoto 601-8306, Japan

<http://www.horiba-adt.jp>

---

For any questions regarding this product, please contact your local agency, or inquire from the following website.

[http://global.horiba.com/contact\\_e/index.htm](http://global.horiba.com/contact_e/index.htm)

---