

Instruction Manual

Benchtop pH/ORP/ION Meter

LAQUA-PH1100

LAQUA-PH1200

LAQUA-PH1300



■ Preface

This manual describes the operation of the following instrument.

Brand (pet name): LAQUA
Series name: Benchtop pH/Water Quality Analyzer
Model: LAQUA-PH1100, LAQUA-PH1200, LAQUA-PH1300
Model description: Benchtop pH/ORP/ION Meter

Be sure to read this manual before using the product to ensure proper and safe operation of the product. Also safely store the manual so it is readily available whenever necessary.

Product specifications and appearance, as well as the contents of this manual are subject to change without notice.

● Warranty and responsibility

HORIBA, Ltd. warrants that the Product shall be free from defects in material and workmanship and agrees to repair or replace free of charge, at option of HORIBA, Ltd., any malfunctioned or damaged Product attributable to responsibility of HORIBA, Ltd. for a period of Two (2) years from the delivery unless otherwise agreed with a written agreement. In any one of the following cases, none of the warranties set forth herein shall be extended;

- Any malfunction or damage attributable to improper operation
- Any malfunction attributable to repair or modification by any person not authorized by HORIBA, Ltd.
- Any malfunction or damage attributable to the use in an environment not specified in this manual
- Any malfunction or damage attributable to violation of the instructions in this manual or operations in the manner not specified in this manual
- Any malfunction or damage attributable to any cause or causes beyond the reasonable control of HORIBA, Ltd. such as natural disasters
- Any deterioration in appearance attributable to corrosion, rust, and so on
- Replacement of consumables

HORIBA, LTD. SHALL NOT BE LIABLE FOR ANY DAMAGES RESULTING FROM ANY MALFUNCTIONS OF THE PRODUCT, ANY ERASURE OF DATA, OR ANY OTHER USES OF THE PRODUCT.

● Trademarks

- Microsoft, Windows, Windows Vista are registered trademarks or trademarks of Microsoft Corporation in the United States and other countries.

Other company names and brand names are either registered trademarks or trademarks of the respective companies. (R), (TM) symbols may be omitted in this manual.

Check Items

■ Check Items

● Items in package

After opening the package, check for damage on the instrument and that the standard accessories (see below) all exist.

If damage or defects are found on the product, contact your dealer.



Instrument

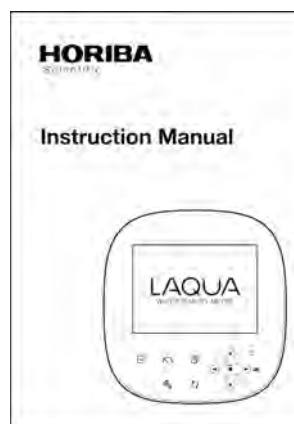

Instruction manual
(this book)

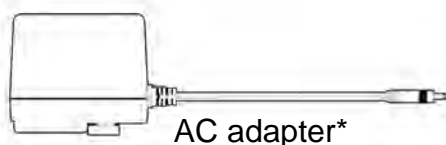

AC adapter*

① Australia	② China	③ Europe	④ Korea	⑤ U.K., Singapore	⑥ USA, Canada, Taiwan

*: The AC adapter includes 6 plug adapters. Referring to the above table, attach the appropriate plug adapter to the AC adapter depending on the country to be used.

Regulations

■ Regulations

● EU regulations

● Conformable standards

This equipment conforms to the following standards:



EMC:	EN61326-1 Class B, Basic electromagnetic environment
Safety:	EN61010-1
RoHS:	EN50581 9. Monitoring and control instruments

Warning: This product is not intended for use in industrial environments. In an industrial environment, electromagnetic environmental effects may cause the incorrect performance of the product in which case the user may be required to take adequate measures.

● Installation environment

This product is designed for the following environment.

- Overvoltage category II
- Pollution degree 2

● Information on disposal of electrical and electronic equipment and disposal of batteries and accumulators

The crossed out wheeled bin symbol with underbar shown on the product or accompanying documents indicates the product requires appropriate treatment, collection and recycle for waste electrical and electronic equipment (WEEE) under the Directive 2012/19/EU, and/or waste batteries and accumulators under the Directive 2006/66/EC in the European Union.

The symbol might be put with one of the chemical symbols below. In this case, it satisfies the requirements of the Directive 2006/66/EC for the object chemical.

This product should not be disposed of as unsorted household waste.

Your correct disposal of WEEE, waste batteries and accumulators will contribute to reducing wasteful consumption of natural resources, and protecting human health and the environment from potential negative effects caused by hazardous substance in products.

Contact your supplier for information on applicable disposal methods.

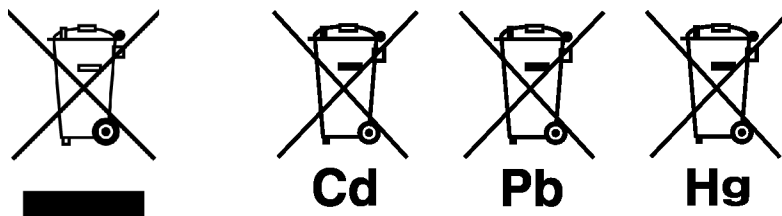

● Authorised representative in EU

HORIBA UK Limited
2 Dalston Gardens, Stanmore, Middx HA7 1BQ, UK

Regulations

● FCC rules

Any changes or modifications not expressly approved by the party responsible for compliance shall void the user's authority to operate the equipment.

● Warning

This equipment has been tested and found to comply with the limits for a Class A digital device, pursuant to part 15 of the FCC Rules. These limits are designed to provide reasonable protection against harmful interference when the equipment is operated in a commercial environment. This equipment generates, uses, and can radiate radio frequency energy and, if not installed and used in accordance with the instruction manual, may cause harmful interference to radio communications.

Operation of this equipment in a residential area is likely to cause harmful interference in which case the user will be required to correct the interference at his own expense.

● Korea certification

● B급 기기 (가정용 방송통신기자재)

이 기기는 가정용(B 급) 전자파적합기기로서 주로 가정에서 사용하는 것을 목적으로 하며, 모든 지역에서 사용할 수 있습니다.

● Taiwan battery recycling mark



Regulations

● China regulation

标记的意义

Meaning of Marking

マークの意味

本标记适用在中华人民共和国销售电器电子产品，标记中央的数字表示环境保护使用期限的年数。(不是表示产品质量保证期间。)只要遵守这个产品有关的安全和使用注意事项，从制造日开始算起在这个年限内，不会给环境污染、人体和财产带来严重的影响。请不要随意废弃本电器电子产品。

This marking is applied to electric and electronic products sold in the People's Republic of China. The figure at the center of the marking indicates the environmental protection use period in years. (It does not indicate a product guarantee period.) It guarantees that the product will not cause environment pollution nor serious influence on human body and property within the period of the indicated years which is counted from the date of manufacture as far as the safety and usage precautions for the product are observed. Do not throw away this product without any good reason.



本マークは、中華人民共和国で販売される電気電子製品に適用され、マークの中央の数字は環境保護使用期限の年数を意味します(製品の品質保証期間を示すものではありません)。この製品に関する安全や使用上の注意をお守り頂く限り、製造日から起算するこの年限内では、環境汚染や人体や財産に深刻な影響を及ぼすことはありません。本製品をみだりに廃棄しないでください。

Regulations

产品中有害物质的名称及含量

Name and amount of hazardous substance used in a product

部件名称 Unit name	有害物质 Hazardous substance					
	铅 Lead (Pb)	汞 Mer- cury (Hg)	镉 Cad- mium (Cd)	六价铬 Hexa- valent chrom- ium (Cr (VI))	多溴联苯 Poly bromo- biphenyl (PBB)	多溴二苯醚 Poly bromo- diphenyl ether (PBDE)
本体 Main unit	×	○	○	○	○	○
电池 Battery	×	○	○	○	○	○
AC适配器 AC adapter ^{*1}	×	○	○	○	○	○
电缆 Cable	×	○	○	○	○	○
支架 Stand ^{*2}	○	○	○	○	○	○
打印机 Printer ^{*2}	×	○	○	○	○	○
电极 Electrode ^{*2}	×	○	×	○	○	○

本表格依据 SJ/T 11364 的规定编制。

This form is prepared in accordance with SJ/T 11364.

○：表示该有害物质在该部件所有均质材料中的含量均在 GB/T 26572 规定的限量要求以下。

Denotes that the amount of the hazardous substance contained in all of the homogeneous materials used in the component is below the limit on the acceptable amount stipulated in the GB/T 26572.

×：表示该有害物质至少在该部件的某一均质材料中的含量超出 GB/T 26572 规定的限量要求。

Denotes that the amount of the hazardous substance contained in any of the homogeneous materials used in the component is above the limit on the acceptable amount stipulated in the GB/T 26572.

*1: 本部件的环保使用期限为10年。 The environmental protection use period of this product is 10 years.

*2: 选配件 Optional products

For Your Safety

■ For Your Safety

● Hazard classification and warning symbols

Warning messages are described in the following manner. Read the messages and follow the instructions carefully.

● Hazard classification

 **DANGER**

This indicates an imminently hazardous situation which, if not avoided, will result in death or serious injury. This is to be limited to the most extreme situations.

 **WARNING**

This indicates a potentially hazardous situation which, if not avoided, could result in death or serious injury.

 **CAUTION**

This indicates a potentially hazardous situation which, if not avoided, may result in minor or moderate injury. It may also be used to alert against unsafe practices.

● Warning symbols



Description of what should be done, or what should be followed



Description of what should never be done, or what is prohibited

● [DEU] Sicherheitsinformation

Lesen Sie vor der Verwendung des Produkts unbedingt diese Anleitung, um den ordnungsgemäßen und sicheren Betrieb des Produkts zu gewährleisten. Bewahren Sie die Anleitung sicher auf, damit sie bei Bedarf jederzeit zur Hand ist.

Die Inhalt dieser Anleitung können ohne Vorankündigung geändert werden.

● Installationsumgebung

Dieses Produkt ist nicht zum Gebrauch in industriellen Umgebungen, wie in EN61326-1 definiert, vorgesehen.

In einer industriellen Umgebung können die elektromagnetischen Störungen eventuell zu Produktfehlfunktionen führen. Um dieses Produkt unter solchen Umständen verwenden zu können, muss der Benutzer ggf. angemessene Maßnahmen ergreifen.

Das Produkt ist gemäß EN61010-1 für die folgende Umgebung vorgesehen.

- Überspannungskategorie II
- Verschmutzungsgrad 2

For Your Safety

● [FRA] Informations de sécurité

Veillez à lire le présent manuel avant d'utiliser le produit de manière à garantir son utilisation correcte et sûre. De même, rangez le manuel dans un lieu sûr de manière à pouvoir vous y reporter lorsque cela est nécessaire.

Le contenu du présent manuel peut être modifié sans notification préalable.

● Environnement d'installation

Ce produit n'est pas destinés à une utilisation dans des environnements industriels, tels que définis dans la norme EN61326-1.

Dans un environnement industriel, les interférences électromagnétiques peuvent entraîner un dysfonctionnement du produit. Pour utiliser le produit dans ce type d'environnements, l'utilisateur peut avoir à prendre des mesures appropriées.

Le produit est conçu pour l'environnement suivant, tel que défini dans la norme EN61010-1.

- Catégorie de surtension II
- Degré de pollution 2

● [ITA] Informazioni sulla sicurezza

Leggere attentamente questo manuale prima di utilizzare il prodotto al fine di utilizzarlo in modo sicuro e adeguato. Inoltre, conservare in un luogo sicuro il manuale per poterlo consultare se necessario.

Le contenuti di questo manuale sono soggetti a modifiche senza preavviso.

● Ambiente di installazione

Questo prodotto non è stati progettati per essere utilizzati in ambienti industriali, secondo la norma EN61326-1.

In un ambiente industriale, le interferenze elettromagnetiche potrebbero causare un malfunzionamento del prodotto. Per utilizzare il prodotto in tali ambienti, all'utente potrebbe essere richiesto di adottare le contromisure necessarie.

Il prodotto è designato per il seguente ambiente, definito nello standard EN61010-1.

- Categoria di sovratensione II
- Livello di inquinamento 2

● [SWE] Säkerhetsinformation

Se till att du läser denna handbok innan du börjar använda produkten för en korrekt och säker användning av den. Spara sedan handboken på en säker och lättåtkomlig plats så att du kan konsultera den när så behövs.

Innehållet i denna handbok kan komma att ändras utan föregående meddelande därom.

● Installationsmiljö

Detta produkten är ej avsedda för användning i industriella miljöer enligt riktlinjerna i EN61326-1.

Om den används i industrimiljöer kan de elektromagnetiska störningarna orsaka tekniska fel hos produkten. Om produkten ska användas i sådana miljöer kan användaren behöva vidta lämpliga åtgärder för att lösa dessa problem.

Produkten är utformad för användning i följande miljöer, i enlighet med SS-EN 61010-1.

- Överspänningskategori II
- Föroreningsgrad 2

For Your Safety

● [SPA] Información de seguridad

Asegúrese de leer este manual antes de utilizar el producto para garantizar un uso correcto y seguro del mismo. Asimismo, guarde de forma segura el manual para que esté disponible siempre que sea necesario.

El contenido de este manual están sujetos a cambios sin previo aviso.

● Entorno de instalación

Este producto está diseñado para su uso en entornos industriales, tal y como se define en EN61326-1.

En un entorno industrial, las interferencias electromagnéticas pueden provocar un funcionamiento incorrecto del producto. Para usar el producto en tales entornos, el usuario debe tomar las medidas adecuadas.

El producto se ha diseñado para el siguiente entorno, definido en EN61010-1.

- Categoría de sobretensión II
- Nivel de contaminación 2

● [POL] Informacje dotyczące bezpieczeństwa

Przed przystąpieniem do użytkowania tego produktu należy dokładnie zapoznać się z niniejszą instrukcją, aby zapewniona była prawidłowa i bezpieczna eksploatacja produktu. Instrukcję przechowywać w bezpiecznym miejscu, aby w razie potrzeby była zawsze dostępna.

Treść niniejszej instrukcji może ulec zmianie bez wcześniejszego powiadomienia.

● Środowisko instalacji

Ten produkt nie są przeznaczone do użytkowania w środowisku przemysłowym, zgodnie z definicją określoną w normie EN61326-1.

W środowisku przemysłowym zakłócenia elektromagnetyczne mogą powodować nieprawidłowe działanie produktów. Możliwe, że aby użytkować produkt w takich środowiskach, użytkownik będzie musiał podjąć stosowne środki zaradcze.

Produkt jest przeznaczony do użycia w poniższym środowisku zdefiniowanym w normie EN61010-1.

- Kategoria przepięciowa II
- Stopień zanieczyszczenia 2

For Your Safety

● [NLD] Veiligheidsinformatie

Lees deze handleiding voordat u dit product gebruikt zodat u het op de juiste manier en veilig kunt gebruiken. Bewaar de handleiding goed zodat u hem wanneer nodig kunt raadplegen.

De inhoud van deze handleiding kunnen zonder voorafgaande kennisgeving worden gewijzigd.

● Installatieomgeving

Dit product is niet bedoeld voor gebruik in een industriële omgeving zoals gedefinieerd in EN 61326-1.

In een industriële omgeving kan de elektromagnetische interferentie de werking van dit product storen. Voor gebruik van het product in een dergelijke omgeving moet de gebruiker mogelijk maatregelen treffen om de storing te verhelpen.

Het product is ontworpen voor de volgende omgeving, gedefinieerd in EN 61010-1.

- Overspanningscategorie II
- Vervuilingsgraad 2

● [JPN] 安全情報

ご使用になる前に、本書を必ずお読みください。お読みになった後は必要なときにすぐに取り出せるように大切に保管してください。

本書に記載されている内容は予告なく変更される場合があります。あらかじめご了承ください。

● 設置環境

本製品は、EN61326-1 で定義される工業環境で使用することを想定した製品ではありません。

工業環境においては、電磁妨害の影響を受ける可能性があり、その場合には使用者が適切な対策を講ずることが必要となる場合があります。

本製品は、EN61010-1 で定義される以下の環境用に設計されています。





- 過電圧カテゴリー II
- 汚染度 2



For Your Safety

● Safety precautions

This section provides precautions for using the product safely and correctly and to prevent injury and damage. The terms of DANGER, WARNING, and CAUTION indicate the degree of imminency and hazardous situation. Read the precautions carefully as it contains important safety messages.

● Instrument and electrode

 WARNING	
	Do not use an unspecified AC adapter. Otherwise, it may heat up or be ignited resulting in a fire or an accident.
	Do not disassemble or modify the instrument. Otherwise, it may heat up or be ignited resulting in a fire or an accident.
	Fire <ul style="list-style-type: none">• For your safety, make sure to unplug the power plug from the electrical outlet when not in use.• Clear dust on the power plug periodically (a few times a year). If the power supply cord is left plugging into the electrical outlet for a long period of time, electrical tracking may occur due to dust and moisture, and it may result in an ignition or a fire.
	Fire or electric shock <ul style="list-style-type: none">• Do not bundle the power supply cord during use.• Do not damage the power supply cord nor apply an excessive load to it, such as bending and stretching it repeatedly, putting a heavy thing on it.• If it cannot be plugged into an electrical outlet firmly, stop use of the power supply cord. If may result in overheating, a fire, an electrical shock, or breakdown.

 CAUTION	
	Harmful chemicals Some ion electrodes are used with hazardous standard solutions. Handle them with care. If the internal solution comes in contact with the skin, wash it off immediately. If it gets into the eyes, flush with plenty of water and then consult a doctor.
	Harmful chemicals The internal solution of pH electrode is highly concentrated potassium chloride (3.33 mol/L KCl). If the internal solution comes in contact with the skin, wash it off immediately. If it gets into the eyes, flush with plenty of water and then consult a doctor.

For Your Safety



CAUTION

**Broken glass**

Broken glass may cause injury. The outer tube and tip of an electrode are made of glass. Handle them with care.



Do not use the RS-232C or USB communication and the AC adapter under wet or humid conditions. Otherwise, it may cause a fire, electric shock, or breakage.

Product Handling Information

■ Product Handling Information

● Operational precautions (instrument)

- Only use the product including accessories for their intended purpose.
- Do not drop, crash, or give any physical impact on the instrument.
- Do not immerse the instrument into alcohol, organic solvent, strong acid, strong alkaline, or the like. The instrument body contains ABS resin, acrylic resin, and some rubber parts.
- If the instrument is dropped into water or gets wet, wipe it using soft cloth. Do not heat to dry it with a hair-dryer (or the like).
- Use fingers to press the operation keys or the touch panel. Do not use a hard object like a metal stick or rod.
- Be careful not to let water into the instruction inside. The instrument is not water-proof.
- To disconnect an electrode or interface cable, hold the connector and pull it off. If you pull at the cable, it may cause a breakage.
- The touch panel is capacitance-type. Make sure to turn OFF the power before cleaning the panel. If you wipe it with the power ON, it may cause instrument malfunction.
- RS-232C or USB communication between the instrument and a personal computer (referred to as PC in the rest of this document) may fail because of environmental conditions, such as (radio/electromagnetic) noise.
- Make sure to use the provided power supply cable to power this product.

● Environmental conditions for use and storage

- Temperature: 0°C to 45°C
- Humidity: under 80% in relative humidity and free from condensation

Avoid the following conditions.

- Strong vibration
- Direct sunlight
- Corrosive gas environment
- Close to an air-conditioner
- Direct wind
- Dusty environment

● Transportation

When transporting the instrument, repackage it in the original package box. Otherwise, it may cause instrument breakage.

Product Handling Information

● Disposal

- Standard solution used for the calibration must be under neutralized before the disposal.
- When disposing of the product, follow the related laws and/or regulations of your country for disposal of the product.

Manual Information

■ Manual Information

● Description in this manual

Note

This interprets the necessary points for correct operation and notifies the important points for handling the product.

Reference

This indicates the part where to refer for information.

Tip

This indicates reference information.

MEMO



Contents

■ Preface.....	I
■ Check Items	II
■ Regulations	III
■ For Your Safety	VII
■ Product Handling Information.....	XIII
Part Names and Basic Operation	1
■ Names of each part	2
● Instrument.....	2
● Identification of manufacturing date	3
● Display	3
● Operation key	4
■ Basic operation.....	5
● Function layer.....	5
● Changing the operation mode	7
● Changing the measurement parameter	8
● Entering numeric values	8
● Saving measurement data in the internal memory	9
Measurement	11
■ Preparation.....	12
● Confirmation before starting measurement	12
● Turning ON the instrument	13
● Connecting an electrode	14
■ pH measurement	15
● Setting the instrument.....	15
● Performing calibration.....	19
● Performing measurement.....	26
● Saving measured values	27

Contents

● Printing measured values in the measurement mode	27
■ mV, ORP measurement	28
● Switching between absolute value and relative value	28
● Performing measurement	29
● Saving measured values	30
● Printing measured values in the measurement mode	30
■ Ion concentration measurement	31
● Setting the instrument.....	31
● Performing calibration	37
● Performing measurement	41
● Saving measured values	42
● Printing measured values in the measurement mode	42
Using Various Functions.....	43
■ Data functions.....	44
● Displaying saved data	44
● Using the automatic data save (default: OFF)	45
● Deleting all saved data	47
■ Measurement settings.....	48
● Displaying the latest calibration and inspection data.....	48
● Using the calibration interval alarm (default: OFF)	50
● Deleting calibration data	51
■ Temperature settings	53
● Calibrating temperature sensor	53
■ General settings.....	55
● Setting the auto stability and auto hold function	55
● Changing the automatic power off setting (default: 30 min)	57
● Resetting to factory default settings	58
● Setting the date and time	59

Contents

● Performing test printing of the printer unit	61
● Setting automatic print	62
● Setting password	63
■ Other settings	65
● Printing measured values and calibration data	65
● Transferring saved data to a PC	70
● Operating the instrument from an external device	71
Maintenance	73
● Contact for maintenance	73
● Maintenance and storage of the instrument.....	73
● Environmental conditions for storage	73
● Maintenance and storage of the pH electrode	74
● Maintenance and storage of the ORP electrode	75
● Checking the state of the ORP electrode.....	76
● Maintenance and storage of the ion electrode.....	77
How to Resolve Errors or Troubles	79
■ When an error message appears	79
● ERROR No.0001 Memory error.....	79
● ERROR No.0004 Asymmetric potential error	80
● ERROR No.0005 Electrode sensitivity error	80
● ERROR No.0006 Maximum calibration points exceeded....	80
● ERROR No.0007 Cannot identify standard solution	81
● ERROR No.0008 Calibration interval error	81
● ERROR No.0009 Printer error.....	81
● ERROR No.0010 Memory full.....	82
■ Troubleshooting	83
● The indicated value fluctuates.....	83
● The response is slow	84

Contents

● The indicated value does not change/No response	84
● The measured value is outside the display range	84
● Repeatability of the measured value is poor	85
● Nothing appears when the power is turned ON.....	85
● Part of the display is missing	85
Appendix.....	87
■ Main specifications.....	87
■ Functions.....	88
■ Instrument default settings.....	89
■ Technical note.....	90
● pH standard solution values at various temperatures.....	90
■ Options	91

Part Names and Basic Operation

This section describes the name of each part and the main role, function, and basic operation method of each part.

■ Names of each part.....	2
● Instrument.....	2
● Identification of manufacturing date	3
● Display.....	3
● Operation key	4
■ Basic operation	5
● Function layer	5
● Changing the operation mode	7
● Changing the measurement parameter.....	8
● Entering numeric values.....	8
● Saving measurement data in the internal memory	9

■ Names of each part

● Instrument

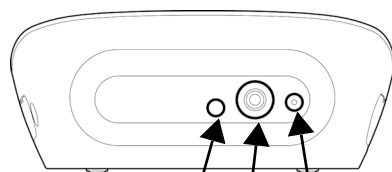
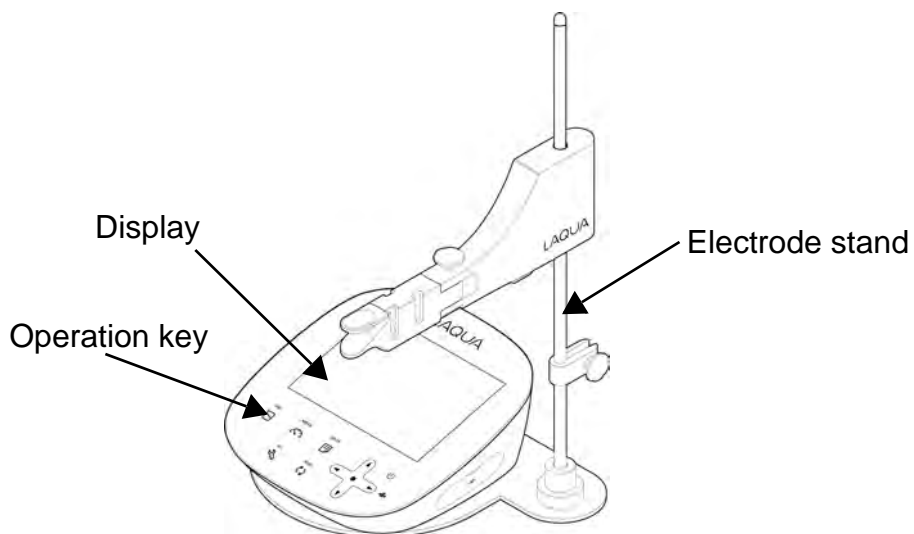

CH1 reference electrode (R) jack
CH1 measurement electrode (G) connector
CH1 temperature electrode (T) jack

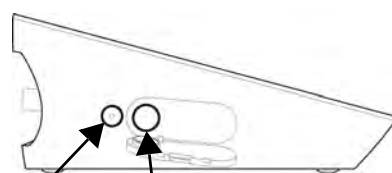

AC adapter jack Printer or RS-232C connector

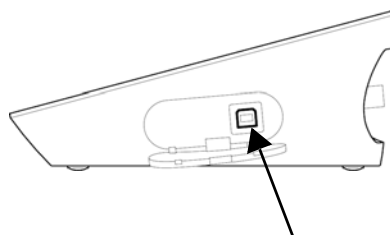

Connector for USB communication with a PC
(LAQUA-PH1200 and LAQUA-PH1300)

● Identification of manufacturing date

Manufacturing date can be identified from MFG No. described in the ID label on the backside of the instrument.

Third number from the left in the MFG No. indicates manufacturing year.

Fourth alphabet from the left in the MFG No. indicates manufacturing month.

The alphabet is assigned to month according to the table below.

Ex.: ID: AA6A0000 means the device manufactured in 2016 January.





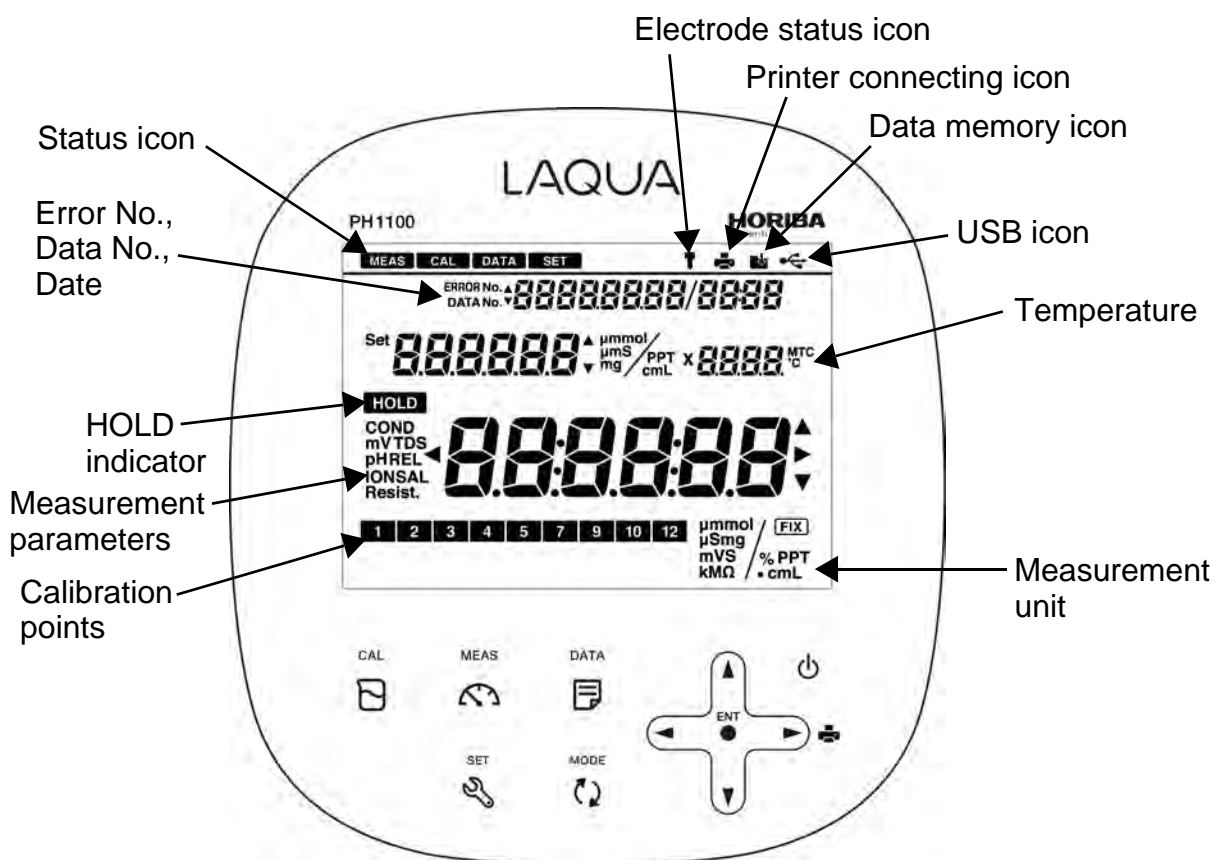



JAN	FEB	MAR	APR	MAY	JUN	JUL	AUG	SEP	OCT	NOV	DEC
A	B	C	D	E	F	G	H	J	K	L	M

● Display



● Operation key

This instrument employs capacitance switches. You cannot operate them with thick gloves. Operate them with bare hands or thin rubber gloves.

Key	Name	Function
CAL 	CAL key	Enters the calibration mode. Performs the calibration.
MEAS 	MEAS key	Enters the measurement mode. Releases the fixed measurement value in auto hold mode.
DATA 	DATA key	Enters the data mode.
SET 	SET key	Enters the setting mode. Cancels the setting values of the setting mode.
MODE 	MODE key	Switches the measurement items.
	▲ key ▼ key	Increases the values. Decreases the values. Switches the setting item. Switches the channels.
	◀▶ key	Changes number of digits, selects functions. Prints out the measurement values. (▶ key)
ENT 	ENTER key	Settlement, execution Saves the measurement data in the measurement mode. Starts/stops automatic data memory.
	POWER key	Turns ON or OFF the power. Press the POWER key for one second or longer to turn ON or OFF the power.

Tip

"ERROR No." icon is displayed on the screen when pressing the invalid key.



■ Basic operation

● Function layer

The function layer of the data mode and setting mode is shown as below.

"dX" and "PXX" indicates the program number which is shown in the screen of the instrument.

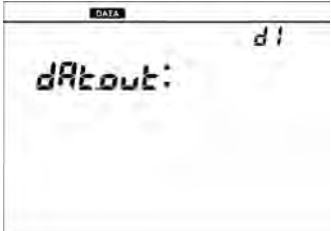
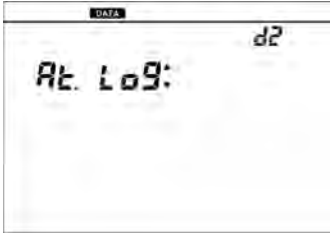
• Data mode

Screen	Layer	Description
	d1: DAT.OUT	Saved data display
	d2: AT. LOG	Automatic data save setting (LAQUA-PH1200 and LAQUA-PH1300 only)
	d3: DAT.CLR	Deletion of saved data

• Setting mode

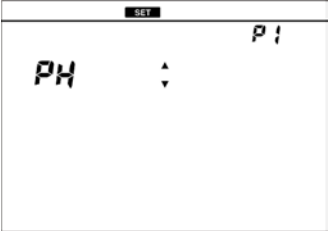
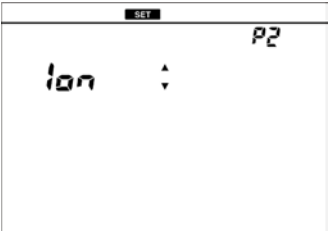
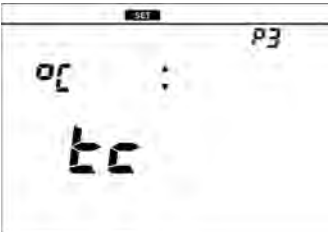
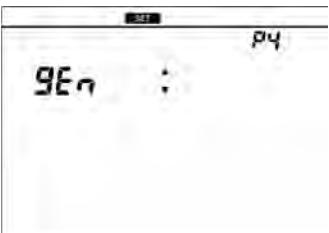
Screen	Layer	Description
	P1: PH	pH measurement settings
	P11: RESOL	Selection of resolution: 0.1, 0.01, 0.001 (LAQUA-PH1100: 0.1, 0.01)
	P12: BUFFER	Selection of standard solution type for calibration: USA, NIST, CUST (LAQUA-PH1100: USA, NIST)
	P13: CAL.DAT	Calibration data display
	P14: CAL.ALR	Calibration alarm setting: 1 day to 400 days*
	P15: CAL.CLR	Deletion of calibration data
	P2: ION	Ion measurement settings (LAQUA-PH1300 only)
	P21: UNIT	Selection of unit: μg/L, mg/L, g/L, mmol/L, mol/L
	P22: CHARGE	Ion valency setting: 1, 2, -2, -1
	P23: CAL.DAT	Calibration data display
	P24: CAL.CLR	Deletion of calibration data
	P3: TC	Temperature setting Selection of temperature conversion: ATC, MTC
	P4: GEN	General settings
	P41: MEAS	Selection of auto hold type: auto stability, auto hold
	P42: AT. OFF	Automatic power off setting: 0 min to 30 min*
	P43: RESET	Initialization of settings
	P44: DATE	Date and time setting*
	P45: PRINT	Test print
	P46: AT. PRN	Automatic print setting
	P47: PASS	Password

*: LAQUA-PH1200 and LAQUA-PH1300 only

Note

PXX indicates the program number and is shown on the screen of instrument. The indication of screen shown in this manual is based on LAQUA-PH1300. The program numbers of LAQUA-PH1100 and LAQUA-PH1200 are different from those of LAQUA-PH1300.

● Changing the operation mode

Change the operation mode from four available modes depending on the purpose of use. The status icon indicates the current mode.

You can change the operation mode using the corresponding key. However changing to the calibration mode, data mode, or setting mode is possible only from the measurement mode. When changing to a different mode, first change to the measurement mode and then change to the desired mode.



Icon	Name	Function
MEAS	Measurement mode	Performs measurement.
CAL	Calibration mode	Performs calibration.
DATA	Data mode	Performs data settings. Displays the saved data.
SET	Setting mode	Performs various settings. Displays the calibration and inspection history.

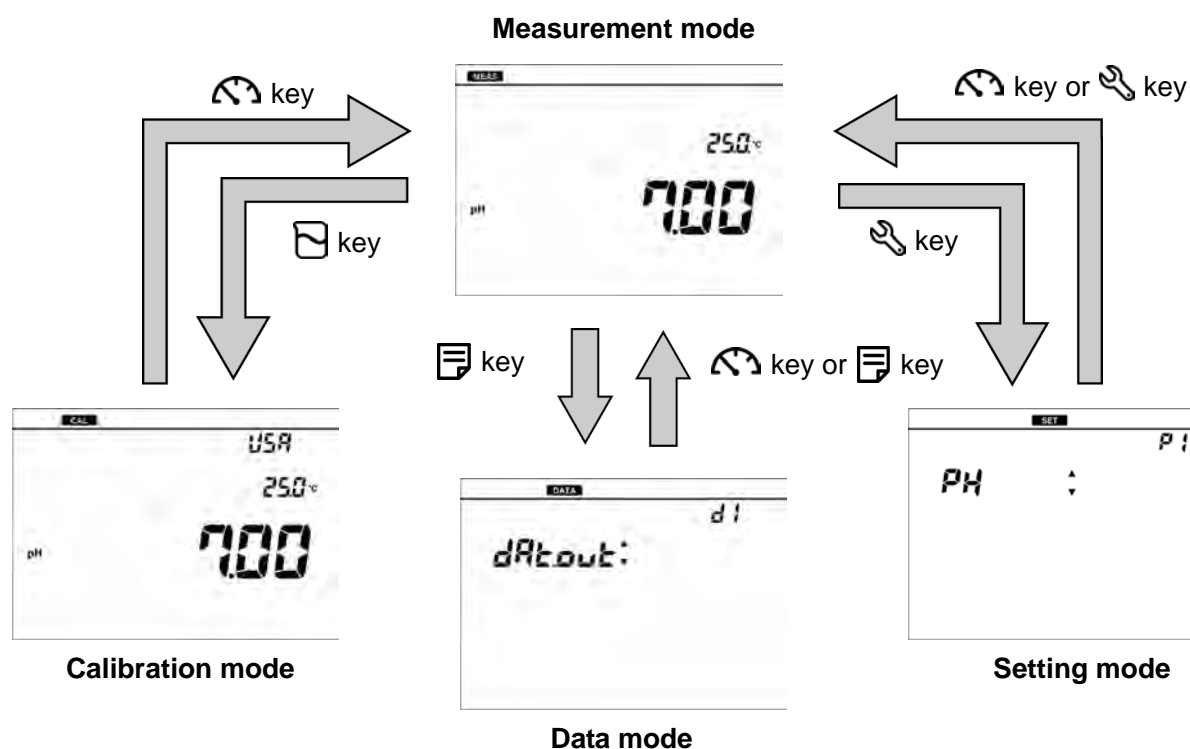



● Changing the measurement parameter

This instrument measures multiple parameters. For measurement, an electrode corresponding to the measurement parameter is required. In the measurement mode, the measurement parameter can be changed by pressing the  key.



● Entering numeric values

When entering numeric values to make various settings and set a calibration value, change the selected digit using the  keys and increment or decrement the value (0 to 9) using the  keys.

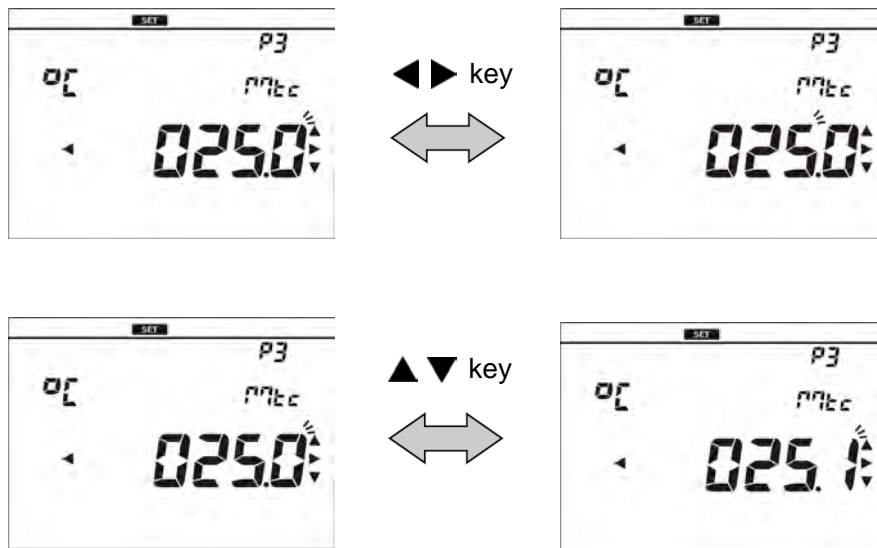

● Saving measurement data in the internal memory

Up to 500 (LAQUA-PH1100) or 999 (LAQUA-PH1200, LAQUA-PH1300) data items measured by the instrument can be stored in the internal memory. Saving the measurement data is possible only when the instrument is in the measurement mode.

1. Press the ● key while the data to save is displayed.

The saved data is displayed for two seconds, and then the display returns to the previous screen automatically.

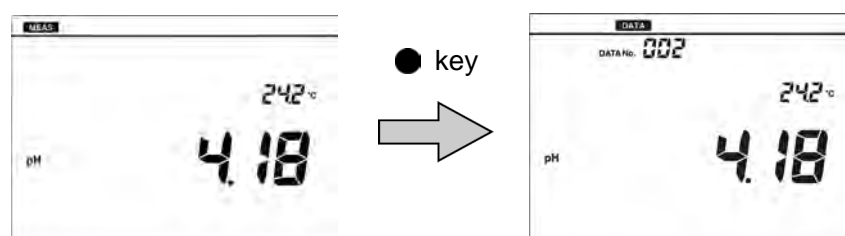

Note

If the data saved reaches 500 (LAQUA-PH1100) or 999 (LAQUA-PH1200, LAQUA-PH1300), an error occurs and "ERROR No. 0010" is displayed. Copy or transfer necessary data to a PC and delete the data from the memory (refer to "Deleting all saved data" (page 47)).

MEMO



Measurement

This section describes the basic measuring method of each measurement parameter.

■ Preparation	12
● Confirmation before starting measurement	12
● Turning ON the instrument.....	13
● Connecting an electrode	14
■ pH measurement.....	15
● Setting the instrument	15
● Performing calibration	19
● Performing measurement.....	26
● Saving measured values	27
● Printing measured values in the measurement mode	27
■ mV, ORP measurement	28
● Switching between absolute value and relative value.....	28
● Performing measurement.....	29
● Saving measured values	30
● Printing measured values in the measurement mode	30
■ Ion concentration measurement	31
● Setting the instrument	31
● Performing calibration	37
● Performing measurement.....	41
● Saving measured values	42
● Printing measured values in the measurement mode	42

■ Preparation

● Confirmation before starting measurement

- Have you prepared the appropriate electrode for the measurement parameter?
⇒ If not, purchase the appropriate electrode.
- Is the prepared electrode in good condition?
⇒ If the responsive part is stained or damaged, it may not be possible to obtain accurate values.
- Have you prepared the appropriate standard solution for the measurement parameter?
⇒ If not, prepare the standard solution according to your applications.
- Are there any items that should not be wet or stained around the instrument?
⇒ Depending on the operation during measurement, items around the instrument could get wet or stained. Secure sufficient space around the instrument and perform measurement while always paying attention to safety.
- Are there any devices that can be a source of noise?
⇒ Measured values could be affected. Do not use the instrument near such devices.
Always ground devices operated by AC power.

● Turning ON the instrument

Perform the following procedure to connect AC adapter to the instrument.

1. Insert the AC adapter cable by fitting with the AC adapter jack.
2. Insert the AC adapter into the electrical socket.

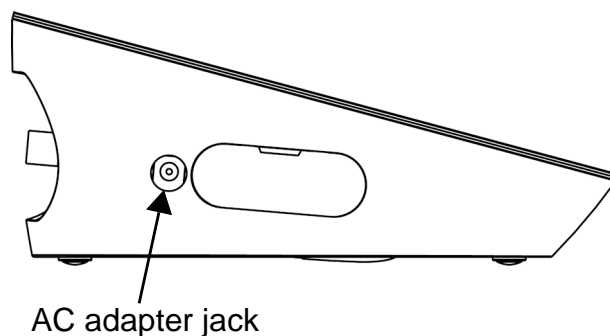

3. Press the  key.

The LCD is fully displayed for one second, and the screen displays the version number of software and the model, and then displays the measurement mode.

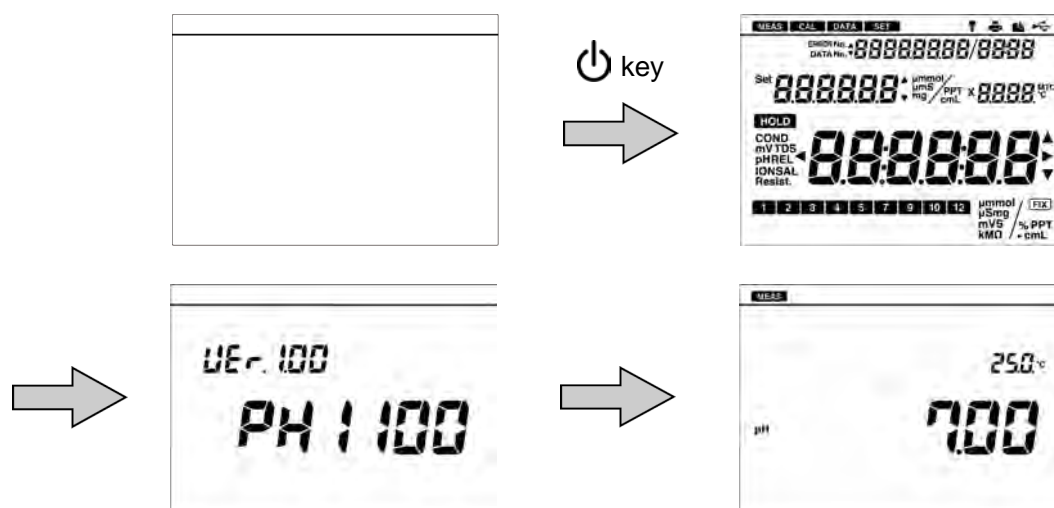

Note

- Do not insert the cable with force when the connector does not match the socket.
- Release your finger from the  key after the power of the instrument is turned ON.
- "VER" indicates the version of software. It may be revised when the software is updated.

● Connecting an electrode

To perform measurement, it is necessary to use the appropriate electrode for measurement parameters. Recommended electrodes for each measured sample are listed in our product catalog and on our website. Refer to them when preparing electrodes. Use the following procedure to correctly connect the electrode to the instrument.

1. Insert the electrode connector by fitting its groove with the connector pin of the CH1 measurement electrode (G).

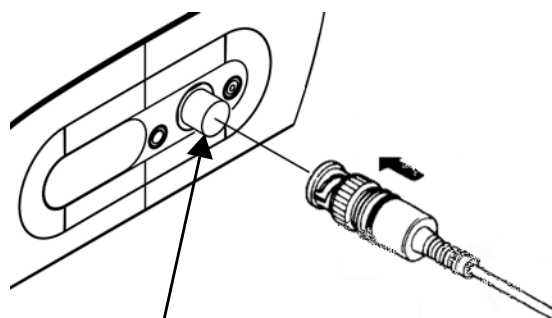

CH1 measurement electrode (G)

2. Turn the electrode connector clockwise by following the groove.

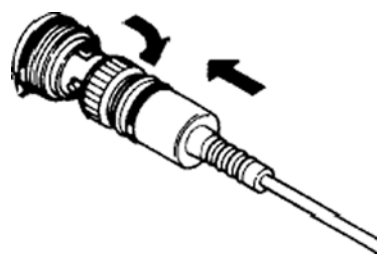

3. Put the connector cover on the connector.

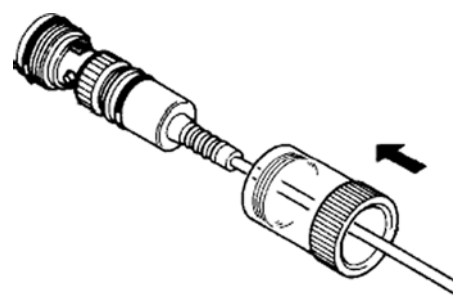

4. When using a combination electrode equipped with a temperature sensor, insert the temperature connector into the jack of the CH1 temperature electrode (T).

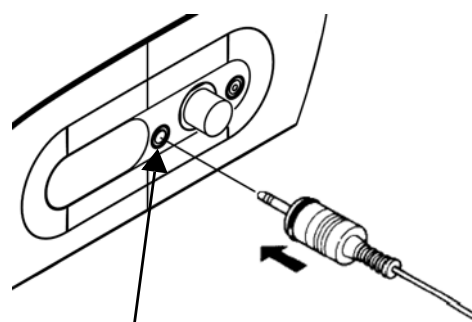

CH1 temperature electrode (T)

Tip

If the temperature connector is unconnected or the connection is wrong, temperature selected for MTC (manual temperature compensation) is displayed as the sample temperature.

Preparation for measurement is complete.

For details of the measurement operation, refer to the following pages.

■ pH measurement

You can measure the pH of the sample with a combination pH electrode or a single pH electrode.

When a single pH electrode is used, the reference electrode is needed and the reference electrode connector has to be inserted into the jack of the CH1 reference electrode (R).



● Setting the instrument

• Setting temperature compensation

Automatic temperature compensation function can be used by using a combination electrode equipped with a temperature sensor or connecting a temperature compensation electrode. By measuring temperature during calibration of the pH standard solution and compensating for the change in pH value of the standard solution due to its temperature changes, you can perform calibration using the value matched to the standard solution temperature (only when the standard solution setting is USA and NIST). However, the function does not convert the pH value according to the temperature characteristics of each sample, and you must record the obtained value together with the sample temperature value. The variation of pH value accompanying the temperature change differs depending on the sample.

If you do not use the automatic temperature compensation function, match the temperature setting of the instrument to the temperature of the standard solution during calibration and match the sample temperature to the temperature setting of the instrument in measurement. By doing so, you can obtain the correct measurement value without being affected by sensitivity variation caused by temperature.

1. Press the  key to enter the setting mode.

2. Press the   keys to select "TC" (temperature setting) and then press the  key.

If the temperature connector is connected, "ATC" (automatic temperature compensation) appears. If not connected, "MTC" (manual temperature compensation) appears.

In the case of "ATC," you can calibrate temperature sensor (refer to "Calibrating temperature sensor" (page 53)).

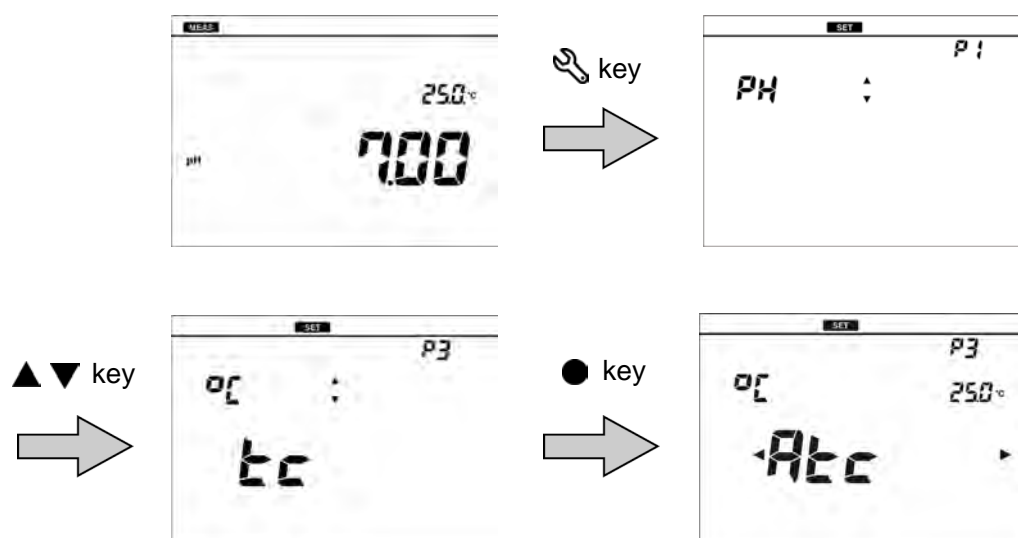

3. In the case of "MTC", enter the temperature to be compensated for and press the ● key to confirm.

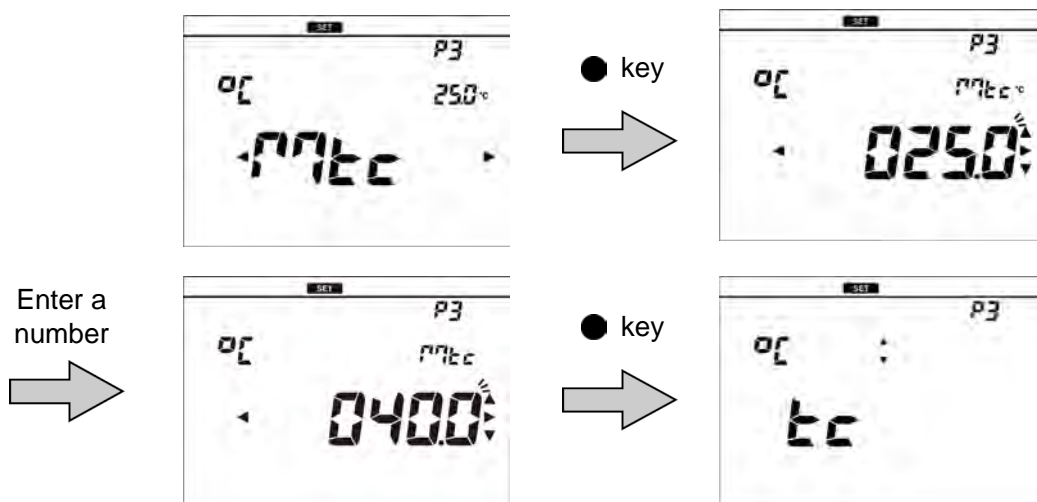

To return to the measurement mode, press the  key.



- **Setting the standard solution used for calibration (default: USA)**



Set the standard solution used for calibration. With this instrument, you can choose from three types, USA, NIST, and CUST (the standard solution other than NIST and USA).

Set according to the standard solution to be used.

CUST can only be selected on LAQUA-PH1200 and LAQUA-PH1300.

1. Press the  key to enter the setting mode.

2. Press the   keys to select "pH" (pH setting) and then press the  key.

3. Press the   keys to select "BUFFER" (pH standard solution setting) and then press the  key.

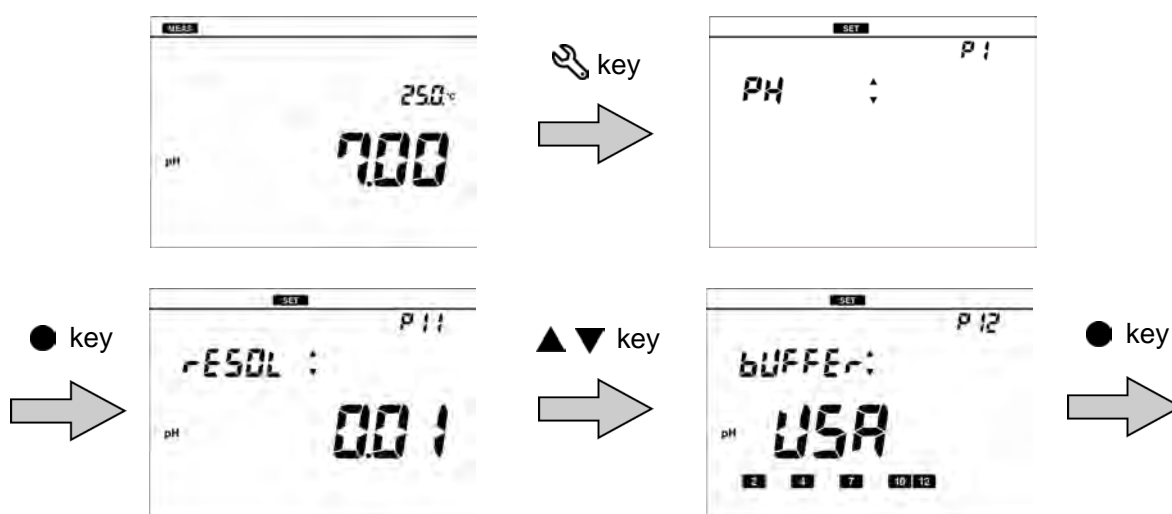

4. Press the ◀▶ keys to select "USA", "NIST", or "CUST" according to the standard solution to be used, and then press the ● key to confirm selection.

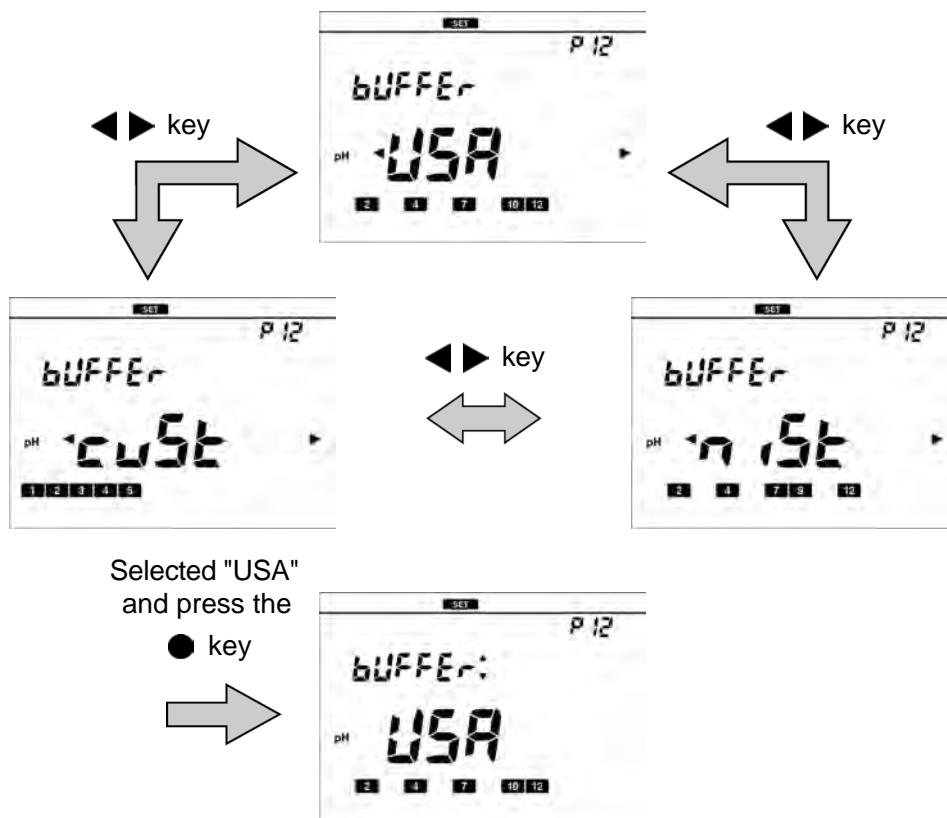

To return to the measurement mode, press the ⏪ key.

• Standard solution type

Standard solution type	Description
USA	Set to use the standard solution of the USA specification.
	Standard solution icon 2 4 7 10 12 pH value: 2 1.679, 4 4.008, 7 7.000, 10 10.011, 12 12.454
NIST	Set to use the standard solution of the NIST specification.
	Standard solution icon 2 4 7 9 12 pH value: 2 1.679, 4 4.008, 7 6.865, 9 9.180, 12 12.454
CUST	Set to use the standard solution of an optional specification.
	Standard solution icon 1 2 3 4 5

● Performing calibration

Calibration is necessary to measure pH accurately.

We recommend performing calibration once a day, before the first measurement.

According to the following procedure, perform calibration accurately.

Note

- Perform two-point calibration using pH 7 and pH 4 when you know that the sample is acidic; pH 7 and pH 10 when you know that the sample is alkaline.
- Perform three-point calibration using pH 4, pH 7, and pH 10 when the sample is unknown.
- You can confirm the current calibration data and delete the calibration data in the setting mode. (Refer to “ Displaying the latest calibration and inspection data ” (page 48), “ Deleting calibration data ” (page 51).)

● pH standard solution setting: USA or NIST

This section describes the procedure for two-point calibration of USA standard, pH 4 and 7, as an example of general calibration.

1. **Clean the pH electrode with pure water (or deionized water) and wipe it with filter paper or tissue paper.**

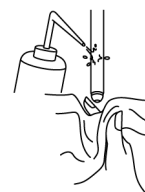

2. **Open the internal solution filler port of the pH electrode.**

If calibration is performed with the port closed, the internal solution does not flow and the measurement value is not stable. Make sure to keep the port open during calibration.

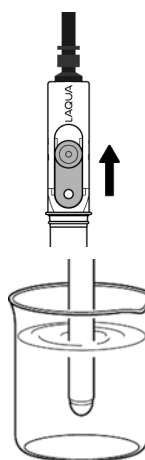

3. **Perform the 1st point calibration. Immerse at least 3 cm from the tip of the pH electrode in the pH 7 standard solution.**

In order for the internal solution to flow into the standard solution, make sure to immerse the liquid junction in the standard solution surely.

4. **Press the  key to enter the calibration mode.**

Stability judgment automatically starts and the pH icon blinks until the measured value stabilizes. When the measured value stabilizes, the pH icon changes from the blinking state to the lit state.

Tip

The standard solution type for the calibration is shown on the upper right screen.

5. Press the ● key or □ key.

Calibration to the standard solution value at the measured temperature is performed. The 1st point calibration ends and "7" calibration history icon lights, indicating that pH 7 calibration is complete.

The display returns to the measurement screen.

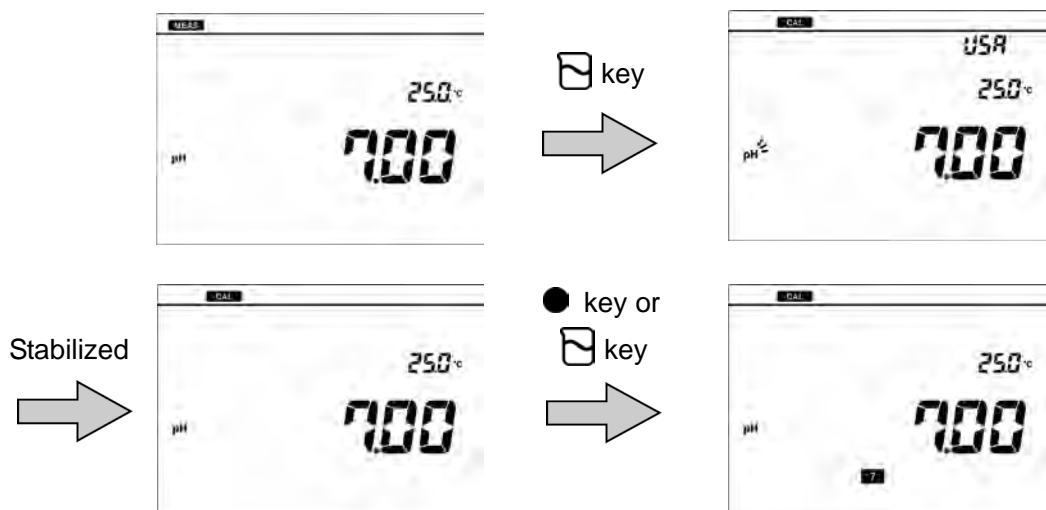

6. Perform the 2nd point calibration. As with the step 1., clean the pH electrode and immerse it in the pH 4 standard solution. As with the step 3., immerse at least 3 cm from the tip of the pH electrode.

7. Press the □ key to enter the calibration mode.

Stability judgment automatically starts and the pH icon blinks until the measured value stabilizes. When the measured value stabilizes, the pH icon changes from the blinking state to the lit state.

8. Press the ● key or □ key.

Calibration to the standard solution value at the measured temperature is performed. The 2nd point calibration ends and "4" calibration history icon lights, indicating that pH 4 calibration is complete.

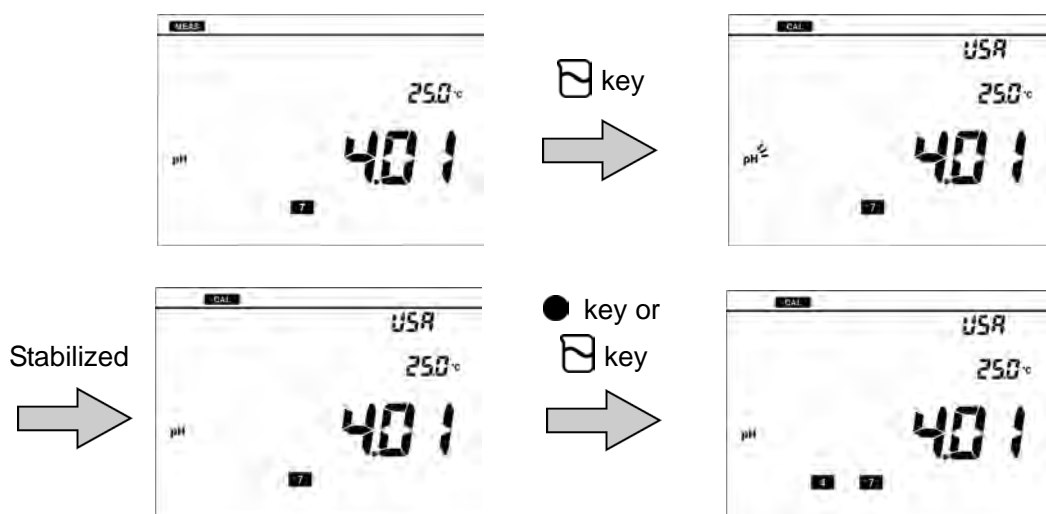

Two-point calibration is complete.

When calibrating three points or more, use the same procedure to continue calibrating the 3rd and subsequent points after the 2nd point calibration. You can calibrate up to five points. Also, you can inspect repeatability using the pH 7 standard solution. About the repeatability inspection procedure, refer to “Inspecting repeatability” (page 22).

Tip

The order of calibration of the standard solution is optional.

In the above example, you can calibrate pH 4 first and then pH 7.

Note

- If calibration of any standard solution is performed again, only the value of calibrated solution is updated. If calibration is repeated, only the calibration value of used standard solution is updated. The calibration values are retained until next calibration is performed, the data is deleted or buffer setting is changed. For the procedure for deleting the calibration data, refer to “Deleting calibration data” (page 51).
 - It is recommended that you should clear the previous calibration data before the calibration in order to perform more accurate calibration.
-

• **Check of the pH electrode status**

After calibration is complete, the current pH electrode status is diagnosed from the calibration result. Refer to the following table for maintenance of the electrode.

Display	Description	Reference
Both ! and ERROR No. are not displayed	Electrode sensitivity: 85% to 100% Good condition.	—
ERROR No.0004 ! blinks	Asymmetry potential: less than -45 mV or excess 45 mV Maintain or replace the electrode.	P. 80
ERROR No.0005 ! blinks	Sensitivity: less than 85% or excess 105% Maintain or replace the electrode.	P. 80

• **Inspecting repeatability**

You can inspect repeatability using the pH 7 standard solution by returning to the calibration screen after calibration ends and pressing the  key. Measure the pH 7 standard solution by using the calibrated electrode to display the difference between the measured value and standard solution value with absolute value.

In order to inspect repeatability, you need to perform calibration of the pH 7 standard solution with either "USA" or "NIST" set as the standard solution.

1. **Clean the calibrated pH electrode with pure water (or deionized water) and wipe it with filter paper or tissue paper.**

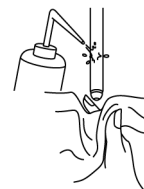

2. **Open the internal solution filler port of the pH electrode.**

If calibration is performed with the port closed, the internal solution does not flow and the measurement value is not stable. Make sure to keep the port open during calibration.

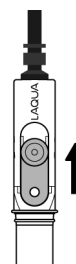

3. **Immerse at least 3 cm from the tip of the pH electrode in the pH 7 standard solution.**

In order for the internal solution to flow into the standard solution, make sure to immerse the liquid junction in the standard solution surely.

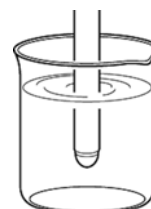

4. **Press the  key to enter the calibration mode.**

5. **Make sure that the pH icon lights while the pH electrode is immersed in the standard solution.**

Stability judgment starts and the pH icon blinks. When the value is stabilized, the pH icon changes from the blinking state to the lit state and the display is fixed to the measured value at the stable time.

6. **Press the  key to start inspection.**

"REP" (repeatability) is shown and display changes to the measurement mode.

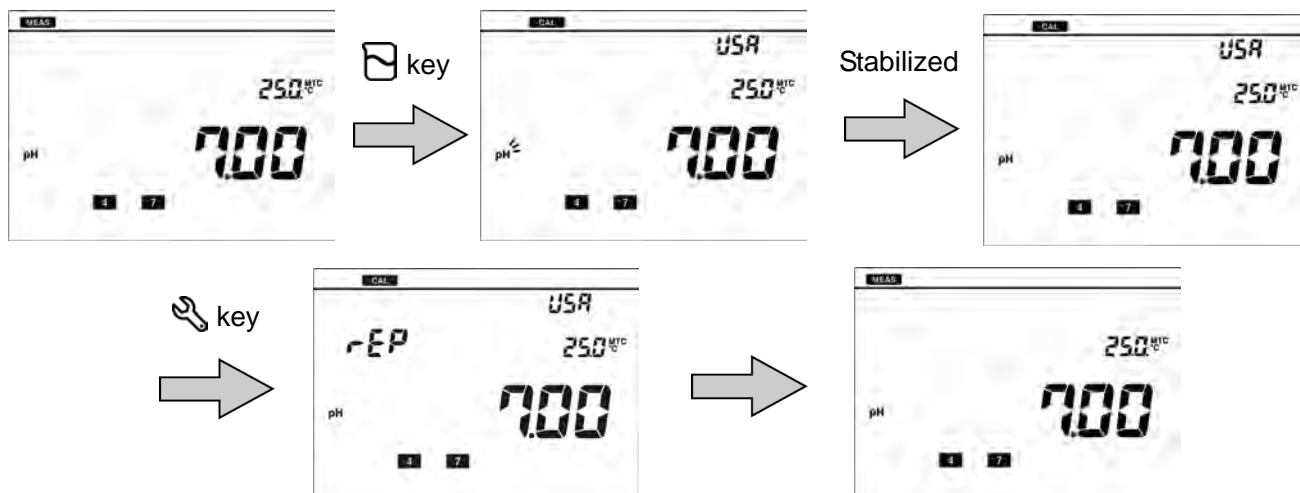

• pH standard solution setting: CUST

This section describes the procedure for two-point calibration.

CUST can only be selected on LAQUA-PH1200 and LAQUA-PH1300.

1. **Clean the pH electrode with pure water (or deionized water) and wipe it with filter paper or tissue paper.**

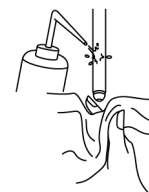

2. **Open the internal solution filler port of the pH electrode.**

If calibration is performed with the port closed, the internal solution does not flow and the measurement value is not stable. Make sure to keep the port open during calibration.

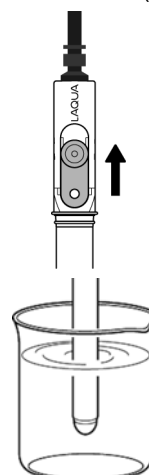

3. **Perform the 1st point calibration. Immerse at least 3 cm from the tip of the pH electrode in standard solution.**

In order for the internal solution to flow into the standard solution, make sure to immerse the liquid junction in the standard solution surely.

4. **Press the  key to enter the calibration mode.**

Stability judgment automatically starts and the pH icon blinks until the measured value stabilizes. When the measured value stabilizes, the pH icon changes from the blinking state to the lit state.

5. Enter the standard solution value and press the ● key or  key.

Calibration to the set standard solution value is performed. The 1st point calibration ends and "1" calibration history icon lights, indicating that 1st point calibration is complete.

The display returns to the measurement screen.

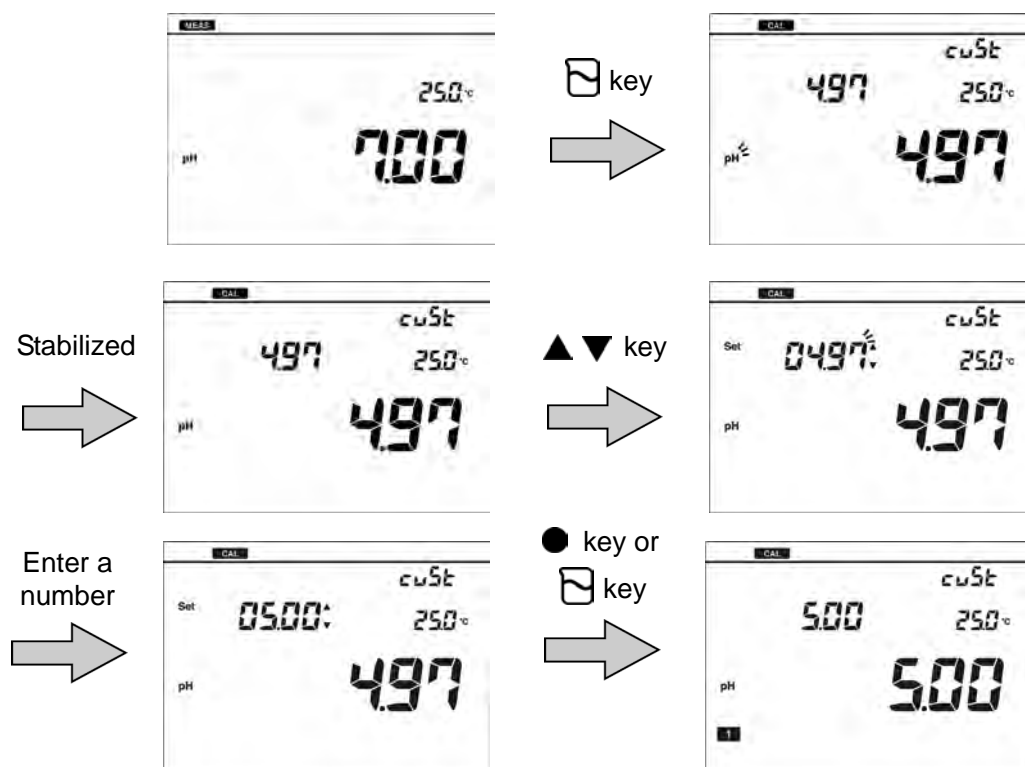

6. Perform the 2nd point calibration. As with the step 1., clean the pH electrode and immerse it in the 2nd standard solution. As with the step 3., immerse at least 3 cm from the tip of the pH electrode.

7. Press the  key to enter the calibration mode.

Stability judgment automatically starts and the pH icon blinks until the measured value stabilizes. When the measured value stabilizes, the pH icon changes from the blinking state to the lit state.

8. Enter the standard solution value and press the ● key or key.

Calibration to the set standard solution value is performed. The 2nd point calibration ends and "2" calibration history icon lights, indicating that 2nd point calibration is complete.

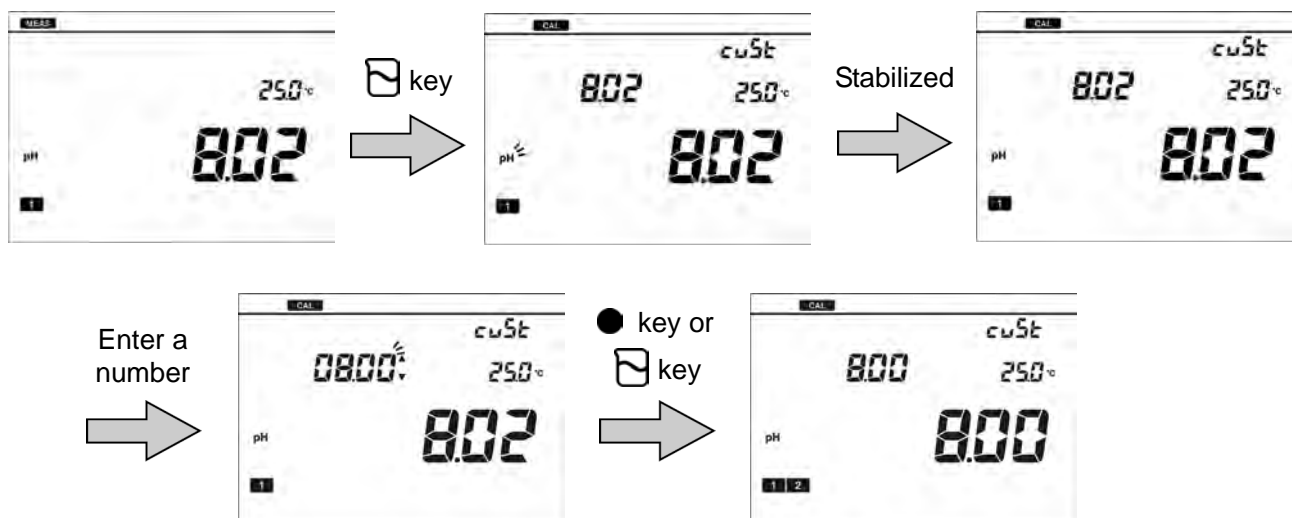

Two-point calibration is complete.



When calibrating three points or more, use the same procedure to continue calibrating the 3rd and subsequent points after the 2nd calibration. You can calibrate up to five points.

Note

- If calibration of any standard solution is performed again, only the value of calibrated solution is updated. If calibration is repeated, only the calibration value of used standard solution is updated. The calibration values are retained until next calibration is performed or the data is deleted. For the procedure for deleting the calibration data, refer to "Deleting calibration data" (page 51).
- It is recommended that you should clear the previous calibration data before the calibration in order to perform more accurate calibration.

• Check of the pH electrode status

After calibration is complete, the current pH electrode status is diagnosed from the calibration result. Refer to the following table for maintenance of the electrode.

Display	Description	Reference
Both  and ERROR No. are not displayed	Electrode sensitivity: 85% to 100% Good condition.	—
ERROR No.0004  blinks	Asymmetry potential: less than -45 mV or excess 45 mV Maintain or replace the electrode.	P. 80
ERROR No.0005  blinks	Sensitivity: less than 85% or excess 105% Maintain or replace the electrode.	P. 80

● Performing measurement

You can perform measurement in the measurement mode by immersing the pH electrode in the sample. You can use the automatic hold function to judge the stability of the measured value. The automatic hold function has two modes, the auto stability mode and the auto hold mode. For the instruction to set the mode, refer to “ Setting the auto stability and auto hold function ” (page 55).

1. **Clean the pH electrode with pure water (or deionized water) and wipe it with filter paper or tissue paper.**

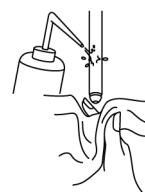

2. **Open the internal solution filler port of the pH electrode.**

If calibration is performed with the port closed, the internal solution does not flow and the measurement value is not stable. Make sure to keep the port open during calibration.

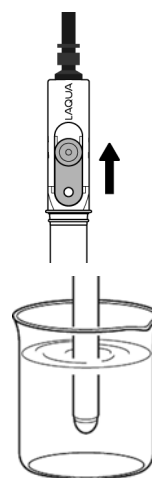

3. **Immerse at least 3 cm from the tip of the pH electrode in the sample solution.**

In order for the internal solution to flow into the sample solution, make sure to immerse the liquid junction in the sample solution surely.

Stability judgment automatically starts and the pH icon blinks until the measured value stabilizes. When the measured value stabilizes, the pH icon changes from the blinking state to the lit state and the display is fixed to the stabilized measured value.

• Auto stability mode

If the measurement pH value does not fulfill stability condition, the fixed value is released. When the measured value fulfills stability condition again, the measured value is fixed.

• Auto hold mode

Press the  key to release fixed the measurement value. When the measured value fulfills stability condition again, the measured value is fixed.

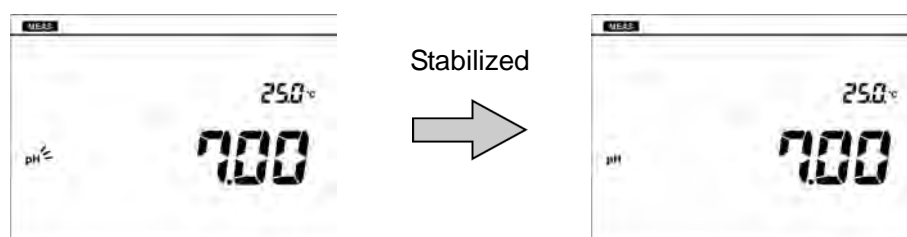

Note

- The criteria of stability judgment in the auto hold measurement are as follows.
Potential variation for 10 seconds is less than 1 mV (0.015 pH equivalent) and temperature variation is less than 2.0°C
- If the measured value is below the display range, "Ur" (under) appears. If the measured value is above the display range, "Or" (over) appears. For details on the action to take, refer to "The measured value is outside the display range" (page 84).

● Saving measured values

To save the measurement data, press the ● key in the screen that you want to save. For details, refer to "Saving measurement data in the internal memory" (page 9).

● Printing measured values in the measurement mode

To print the measurement data, press the ► key in the screen that you want to print. For details, refer to "Printing measured values and calibration data" (page 65).

■ mV, ORP measurement

You can measure the electromotive force between the electrode and the sample by using a pH electrode. The mV value can be used to understand the status of the electrode in the mV measurement.

You can measure the ORP (oxidation-reduction potential) of the sample by using an ORP electrode in the ORP measurement.

In the measurement mode, press the  key to change the measurement parameter to "mV".

● Switching between absolute value and relative value



There are two types of measurement mode for the mV and ORP measurement, the absolute value measurement and the relative value measurement.

- Absolute value measurement mode

The measured value of electromotive force is displayed.

- Relative value measurement mode

The measured value of electromotive force of a sample is corrected to 0 mV and set as a relative value. When the electromotive force of another sample is measured, the difference value between the relative value and the measured value is displayed.

The default mode is the absolute value measurement mode. Pressing the  key switches to the relative value measurement mode. Pressing the  key again returns to the absolute value measurement mode.

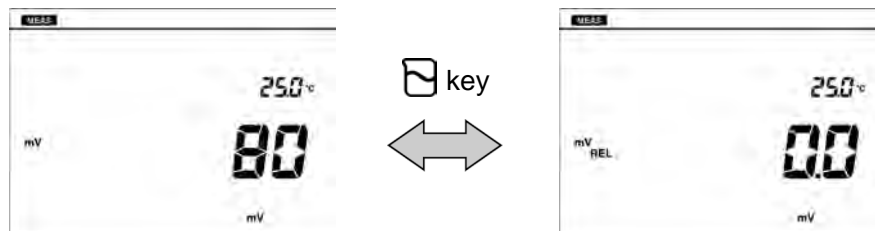

● Performing measurement

You can perform measurement in the measurement mode by immersing the pH electrode in the sample. Also, you can use the automatic hold function to judge the stability of the measured value. The automatic hold function has two modes, the auto stability mode and the auto hold mode. For how to set the mode, refer to “ Setting the auto stability and auto hold function ” (page 55).

1. **Clean the electrode with pure water (or deionized water) and wipe it with filter paper or tissue paper.**

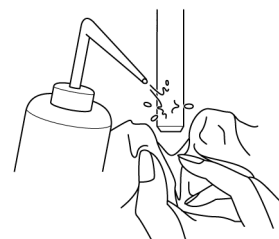

2. **Open the internal solution filler port of the electrode.**

If measurement is performed with the port closed, the internal solution does not flow and the measurement value is not stable. Make sure to keep the port open during measurement.

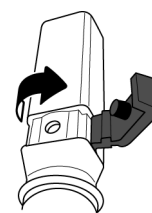

3. **Immerse at least 3 cm from the tip of the electrode in the sample solution.**

In order for the internal solution to flow into the sample solution, make sure to immerse the liquid junction in the sample solution surely.

Stability judgment automatically starts and the mV icon blinks until the measured value stabilizes. When the measured value stabilizes, the mV icon changes from the blinking state to the lit state, and the display is fixed to the stabilized measured value.

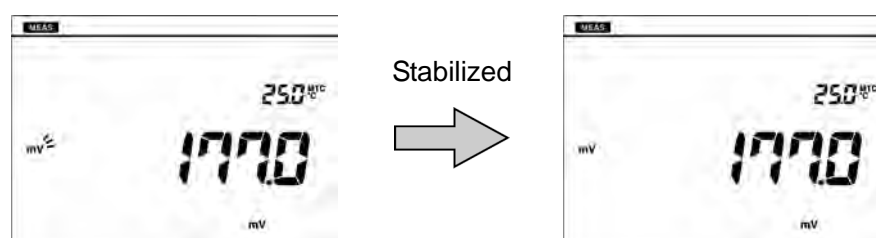
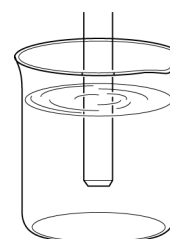

Note

- The criteria of stability judgment in the auto hold measurement are as follows.
Potential variation for 10 seconds is less than 1 mV and temperature variation is less than 2.0°C
 - If the measured value is below the display range, "Ur" (under) appears. If the measured value is above the display range, "Or" (over) appears. For details on the action to take, refer to " The measured value is outside the display range " (page 84).
 - Note that when measuring the ORP of a sample solution that has extremely low concentrations of oxidants and reductants (such as tap water, well water, or water treated with purifying equipment), there may be less responsiveness and repeatability in general.
 - If alkaline water is left, its ORP value changes considerably. Always measure alkaline ion water promptly.
-

● Saving measured values

To save the measurement data, press the ● key in the screen that you want to save. For details, refer to " Saving measurement data in the internal memory " (page 9).

● Printing measured values in the measurement mode

To print the measurement data, press the ► key in the screen that you want to print. For details, refer to " Printing measured values and calibration data " (page 65).

■ Ion concentration measurement

You can measure the concentration of a specific ion with an ion electrode.

Press the  key in the measurement mode to change the measurement parameter to "ION".

Measurement of ion concentration is only possible on LAQUA-PH1300.

Note

- Ion concentration varies depending on the sample temperature. For the accurate measurement, it is suggested that the calibration and measurement should be confirmed at a constant temperature using a constant temperature bath.
- To get accurate values, stir the standard solution and the sample solution using a stirrer during calibration and measurement.

● Setting the instrument

• Setting the temperature compensation

Because the ion electrode is not equipped with a temperature sensor, the temperature electrode must be connected in order to use the automatic temperature compensation (ATC). In ATC mode, the Nernst slope (mV/one decade) is automatically changed corresponding to the measured temperature by the temperature sensor. If you do not use the automatic temperature compensation function, match the temperature setting of the instrument to the temperature of the standard solution during calibration and match the sample temperature to the temperature setting of the instrument in measurement. By doing so, you can obtain the correct measurement value without being affected by sensitivity variation caused by temperature. This cannot be set separately from the automatic temperature compensation setting for pH and the automatic temperature measurement setting for mV (ORP).

1. Press the  key to enter the setting mode.

2. Press the   keys to select "TC" (temperature setting) and then press the  key.

If the temperature connector is connected, "ATC" (automatic temperature compensation) appears. If not connected, "MTC" (manual temperature compensation) appears.

In the case of "ATC," you can calibrate the temperature sensor (refer to "Calibrating temperature sensor" (page 53)).

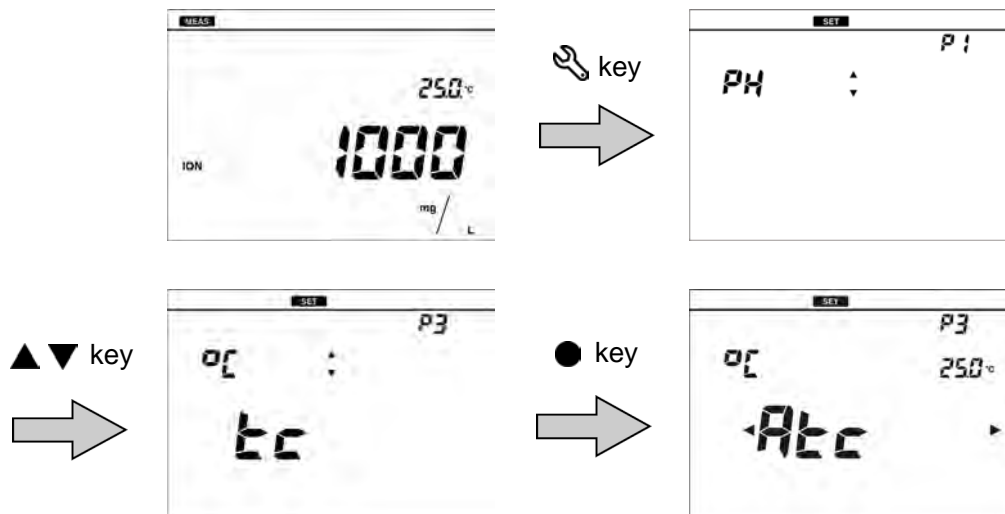



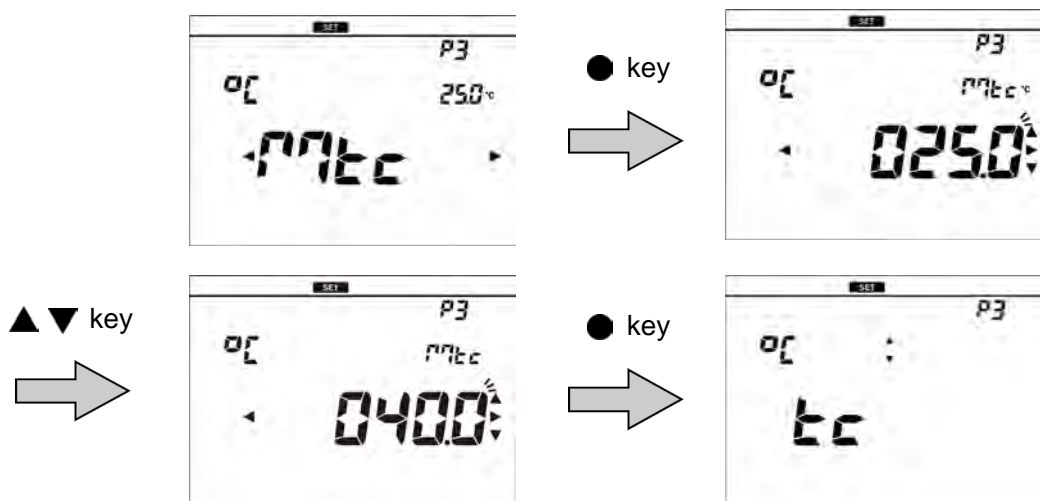



3. In the case of "MTC", enter the temperature to display and press the  key to confirm.



To return to the measurement mode, press the  key.

• **Setting the ion concentration unit (default: mg/L)**

According to the purpose, you can select the unit of ion concentration from $\mu\text{g/L}$, mg/L , g/L , mmol/L , mol/L .

1. Press the  key to change to the setting mode.
2. Press the   keys to select "ION" (ion setting) and then press the  key.
3. Press the   keys to select "UNIT" (ion concentration unit setting) and then press the  key.

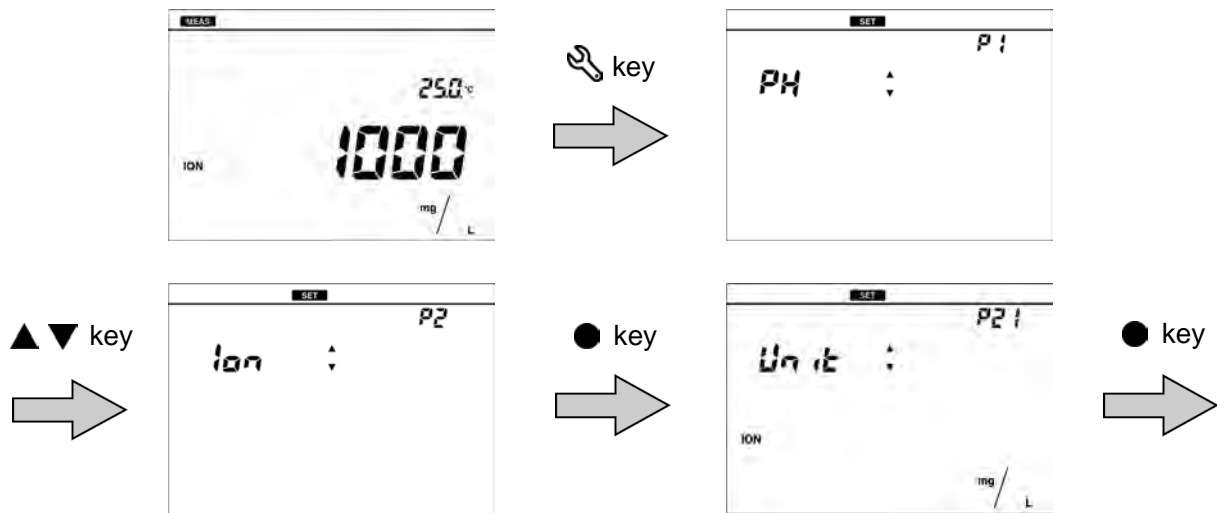

4. Press the ◀▶ keys to select the unit and press the ● key to confirm selection.

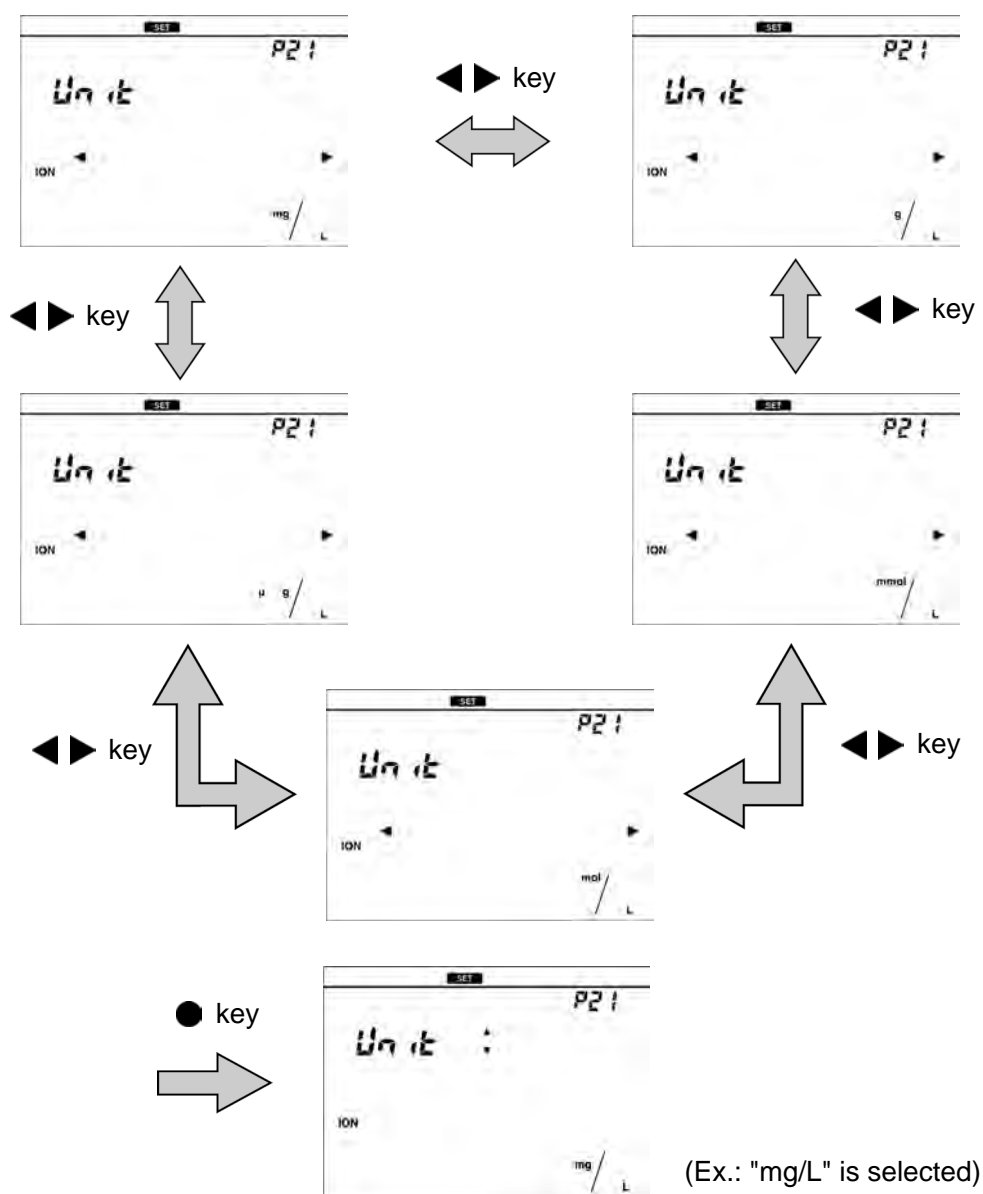





To return to the measurement mode, press the ↻ key.

Note

- Be sure to set the unit before performing calibration, as the calibration calculation varies depending on the unit and ion valency. If not, incorrect measurement values may result. After changing the unit or ion valency of the sample, change the setting as appropriate for the ion valency of the sample and recalibrate prior to performing measurement.
- When the unit of ion concentration is changed, the previous calibration data is deleted.

• **Setting the ion valency of sample (default: 1)**

Because the calculation formula varies depending on the type of ion, the ion valency must be set. Select the calculation formula according to the type of sample solution to be measured.

1. Press the  key to enter the setting mode.
2. Press the  keys to select "ION" (ion setting) and then press the  key.
3. Press the  keys to select "CHARGE" (ion valency setting) and then press the  key.

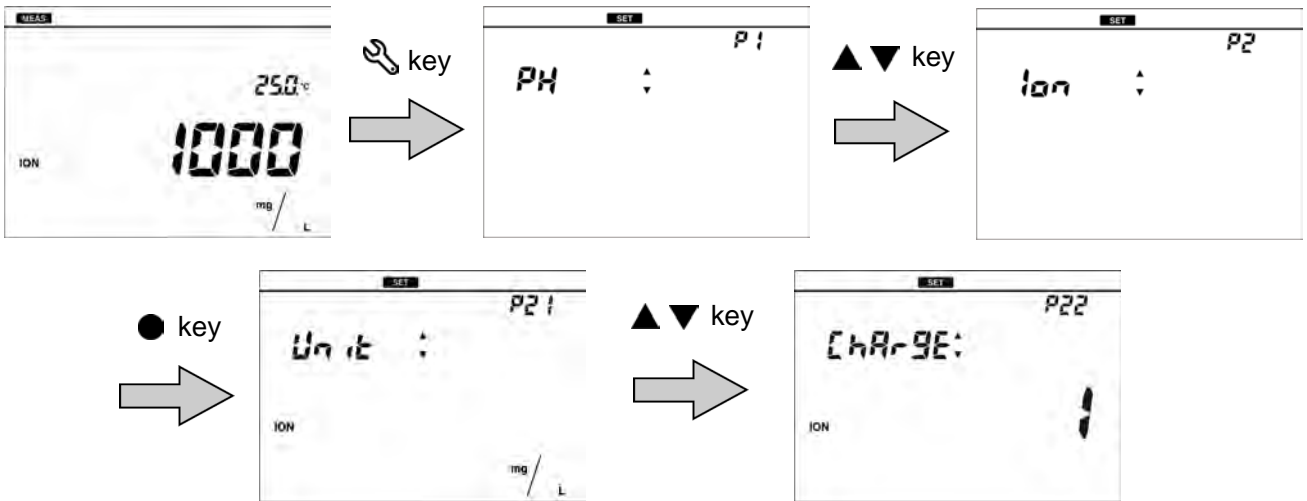

4. Press the  keys to select the ion valency and press the  key to confirm.

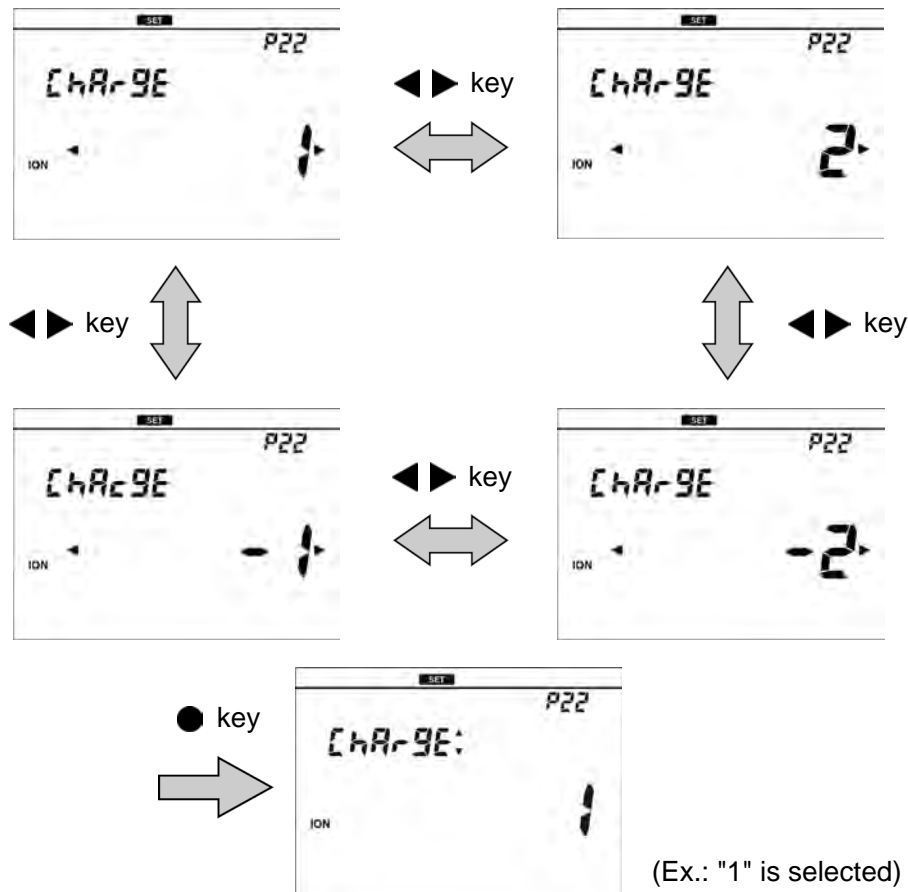

To return to the measurement mode, press the  key.

Note

- Be sure to set the ion valency before performing calibration, as the calibration calculation varies depending on the unit and ion valency. If not, incorrect measurement values may result. After changing the unit or ion valency of the sample, change the setting as appropriate for the ion valency of the sample and recalibrate prior to performing measurement.
 - When the ion valency setting is changed, the previous calibration data is deleted.
-

● Performing calibration

Calibration is necessary to measure ion concentration.

We recommend performing calibration once a day, before measurement.

According to the following procedure, perform calibration accurately. To prepare the standard solution, refer to the instruction manual for the ion electrode.

Conditioning of the electrode is necessary when the electrode has not been used for a long time. Refer to the table below to condition the electrode.

Ion	Conditioning solution	Immerse time
Cl^-	100 mg/L Cl^- solution	Approx. 10 min
F^-	Pure water (or deionized water)	Approx. 10 min
NO_3^-	1 mol/L potassium nitrate solution (100 g/L KNO_3)	2 to 3 hours
K^+	0.1 mol/L potassium chloride solution (7.5 g/L KCl)	Approx. 12 hours
Ca^{2+}	Tap water	Approx. 3 hours
NH_3	No conditioning	—

Note

- For performing calibration or measurement, replace the internal solution inside the outer tube of the ion electrode before using the electrode.
- Prepare at least 100 mL of the standard solution for calibration. An insufficient volume may cause the measured value to drift.

- 1. Clean the ion electrode with pure water (or deionized water) and wipe it with filter paper or tissue paper.**

Do not directly touch the responsive membrane.

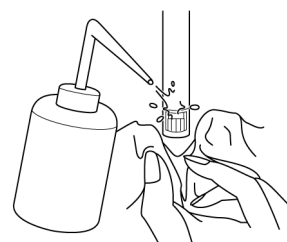

- 2. Open the internal solution filler port of the ion electrode.**

If calibration is performed with the port closed, the internal solution does not flow and the measurement value is not stabilized. Make sure to keep the port open during calibration.

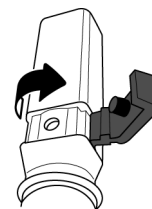

- 3. Perform the 1st point calibration. Immerse at least 3 cm from the tip of the ion electrode in the standard solution.**

Make sure that the responsive membrane is immersed.

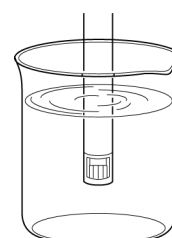

4. Press the  key to enter the calibration mode.

Stability judgment starts automatically and the ion icon blinks. When the measured value stabilizes, the ion icon changes from the blinking state to the lit state, and the display is fixed to the stabilized measured value.

5. Press the   keys to enter the ion concentration value of the standard solution used for calibration.

To change the decimal point, press the  key.

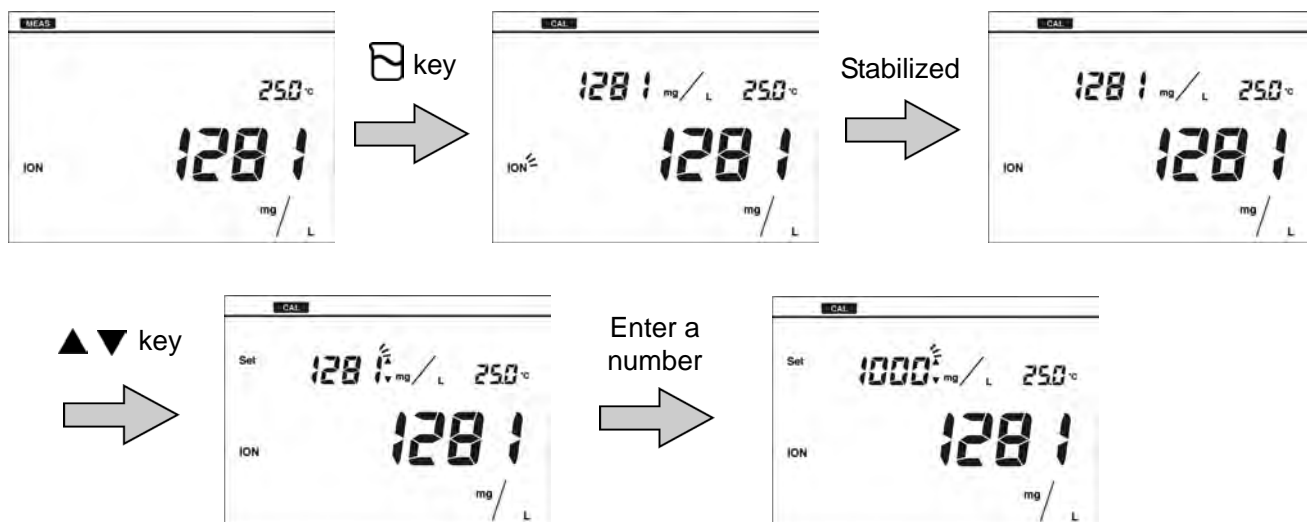

Note

The ion concentration value of the standard solution can be entered even when "Or" is displayed on the screen.

6. Press the  key or  key.

Calibration to the set standard solution value is performed. The 1st point calibration ends and "1" calibration history icon lights, indicating that 1st point calibration is complete.

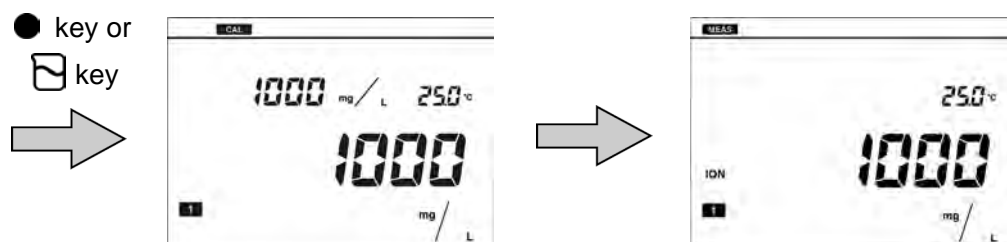

7. Perform the 2nd point calibration. As with the step 1., clean the ion electrode and immerse it in the 2nd standard solution. As with the step 3., immerse at least 3 cm from the tip of the ion electrode.

8. Press the  key to enter the calibration mode.

Stability judgment automatically starts and the ion icon blinks until the measured value stabilizes. When the measured value stabilizes, the ion icon changes from the blinking state to the lit state.

9. Press the ▲▼ keys to enter the ion concentration value of the standard solution used for calibration.

To change the decimal point, press the  key.

10. Press the  key or ● key.

Calibration to the set standard solution value is performed. The 2nd point calibration ends and "2" calibration history icon lights, indicating that 2nd point calibration is complete.

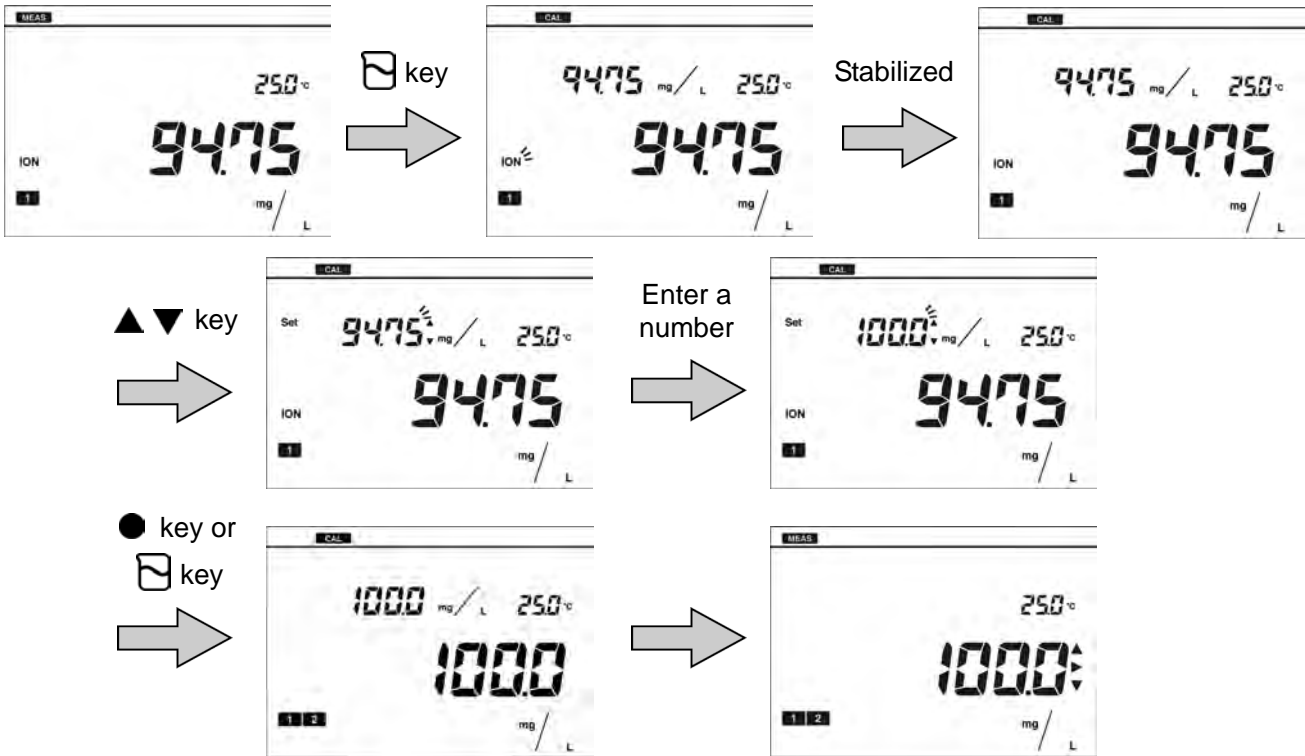

Two-point calibration is complete.

When calibrating three points or more, use the same procedure to continue calibrating the 3rd and subsequent points after the 2nd point calibration. You can calibrate up to five points.

Note

- If calibration of any standard solution is performed again, only the value of calibrated solution is updated. If calibration is repeated, only the calibration value of used standard solution is updated. The calibration values are retained until next calibration is performed or the data is deleted. For the procedure for deleting the calibration data, refer to “Deleting calibration data” (page 51).
- It is recommended that you should clear the previous calibration data before the calibration in order to perform more accurate calibration.

- **Check of the ion electrode status**

After calibration is complete, the current ion electrode status is diagnosed from the calibration result.

Display	Description	Reference
ERROR No. is not displayed	Good condition.	—
ERROR No.0005	Ion valency setting is incorrect or sensitivity setting is out of the measurable range. Set the correct ion valency. If the setting is correct but an error still occurs, perform electrode maintenance or replace the electrode.	P. 80

● Performing measurement

You can perform measurement in the measurement mode by immersing the ion electrode in the sample. Also, you can use the automatic hold function to judge the stability of the measured value. The automatic hold function has two modes, the auto stability mode and the auto hold mode. For how to set the mode, refer to “ Setting the auto stability and auto hold function ” (page 55).

Note

- For performing calibration or measurement, replace the internal solution inside the outer tube of the ion electrode before using the electrode.
- Prepare at least 100 mL of the sample solution for measurement. An insufficient volume may cause the measured value to drift.

- 1. Clean the ion electrode with pure water (or deionized water) and wipe it with filter paper or tissue paper.**

Do not directly touch the responsive membrane.

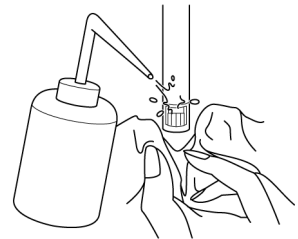

- 2. Open the internal solution filler port of the ion electrode.**

If measurement is performed with the port closed, the internal solution does not flow and the measurement value is not stabilized. Make sure to keep the port open during calibration.

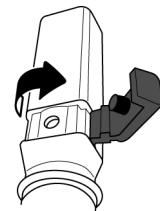

- 3. Immerse at least 3 cm from the tip of the ion electrode in the sample solution**

Make sure that the responsive membrane is immersed.

Stability judgment automatically starts and the pH icon blinks until the measured value stabilizes. When the measured value stabilizes, the pH icon changes from the blinking state to the lit state, and the display is fixed to the stabilized measured value.

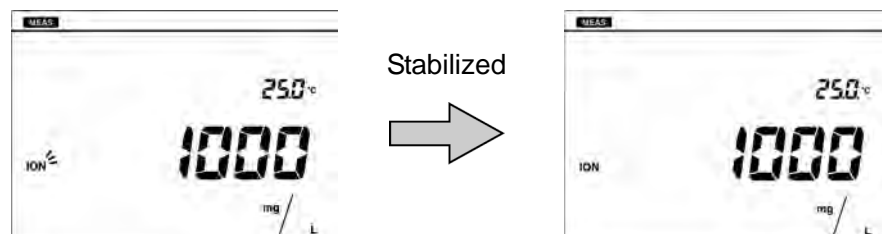
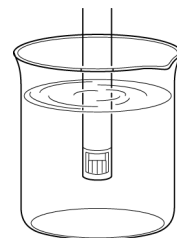

Note

- The criteria of stability judgment in the auto hold measurement are as follows.
Potential variation for 10 seconds is less than 1 mV and temperature variation is less than 2.0°C
 - If the measured value is below the display range, "Ur" (under) appears. If the measured value is above the display range, "Or" (over) appears. For details on the action to take, refer to " The measured value is outside the display range " (page 84).
-

● Saving measured values

To save the measurement data, press the ● key in the screen that you want to save. For details, refer to " Saving measurement data in the internal memory " (page 9).

● Printing measured values in the measurement mode

To print the measurement data, press the ► key in the screen that you want to print. For details, refer to " Printing measured values and calibration data " (page 65).

Using Various Functions

This section describes functions available in this instrument.

■ Data functions.....	44
● Displaying saved data.....	44
● Using the automatic data save (default: OFF).....	45
● Deleting all saved data.....	47
■ Measurement settings.....	48
● Displaying the latest calibration and inspection data	48
● Using the calibration interval alarm (default: OFF).....	50
● Deleting calibration data.....	51
■ Temperature settings	53
● Calibrating temperature sensor	53
■ General settings.....	55
● Setting the auto stability and auto hold function.....	55
● Changing the automatic power off setting (default: 30 min).....	57
● Resetting to factory default settings	58
● Setting the date and time.....	59
● Performing test printing of the printer unit.....	61
● Setting automatic print	62
● Setting password	63
■ Other settings	65
● Printing measured values and calibration data.....	65
● Transferring saved data to a PC	70
● Operating the instrument from an external device	71

■ Data functions

● Displaying saved data

You can display the data saved in the internal memory.



1. Press the  key to enter the data mode.

2. Press the ▲ ▼ keys to select "DAT.OUT" (display saved data) and then press the ● key.

Press the ▲ ▼ keys to change the measurement data and press the ◀ keys to change the display between date and data number.

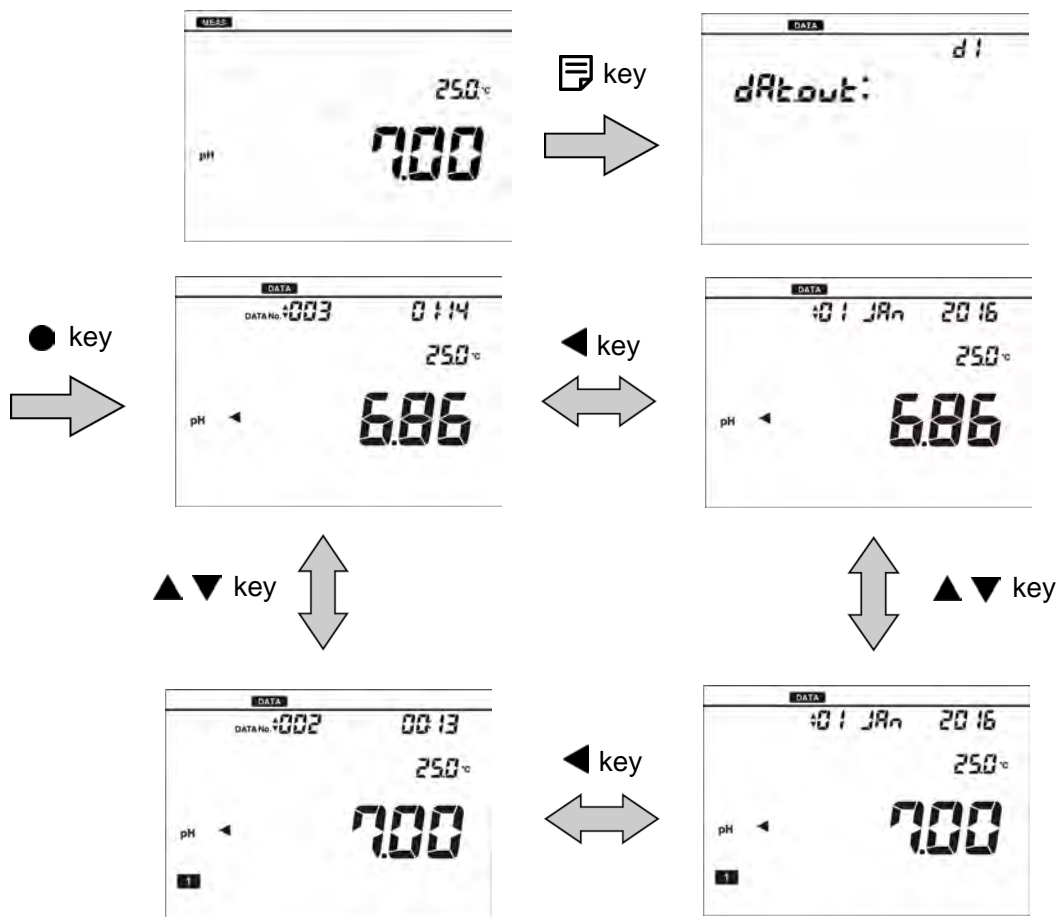
When pressing the ▶ key, the data is printed.







To return to the measurement mode, press the  key and then press the  key.

● Using the automatic data save (default: OFF)

This function saves the data in the internal memory of the instrument at the specified interval automatically.

While using this function, auto stability and hold mode are not available and the automatic power off setting is disabled.

This function is available for LAQUA-PH1200 and LAQUA-PH1300.

1. Press the  key to enter the data mode.
2. Press the   keys to select "AT. LOG" (automatic data save) and then press the  key.

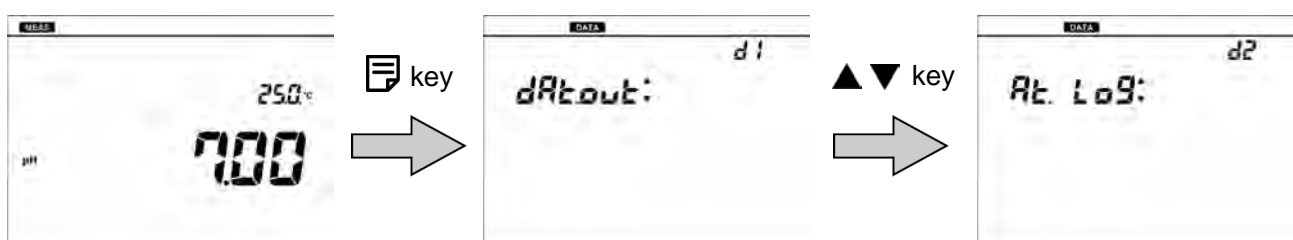

3. Enter the save interval (seconds), and press the  key.

An interval from 0, 2 s to 3600 s can be set.

When "0" is entered, this function is set to OFF.

4. Enter the save period (minutes), and press the  key.

A period from 0 min to 3600 min can be set.

"0" indicates no period.

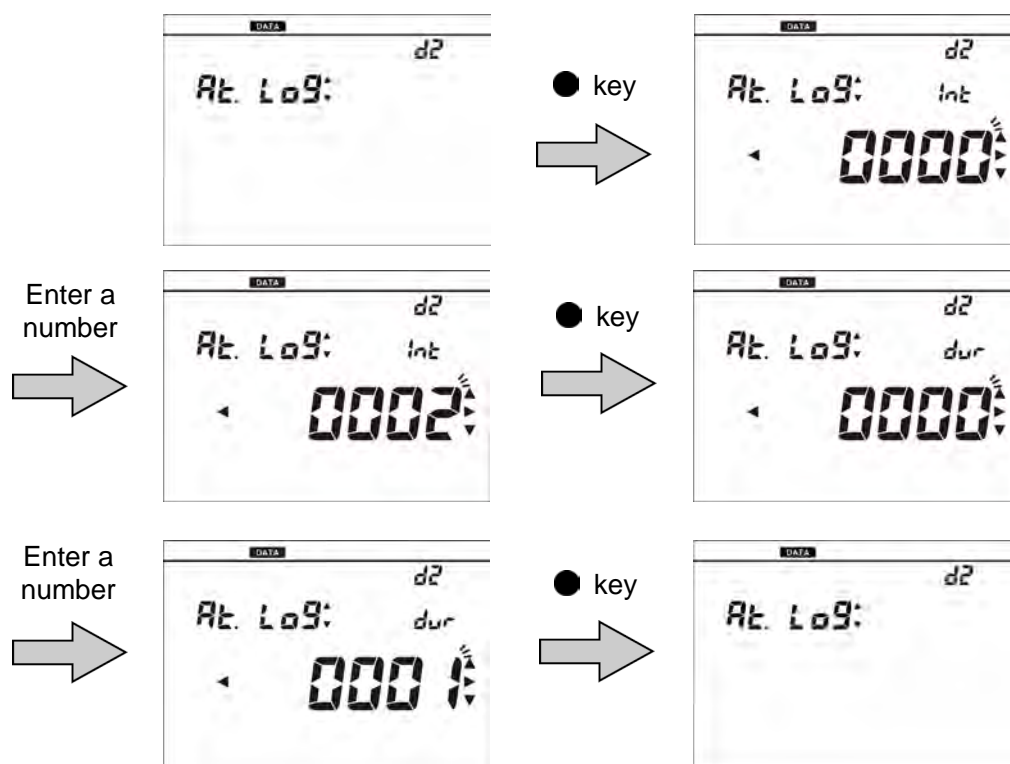

5. Press the  key to enter the measurement mode.

6. Pressing the ● key starts saving the data (when the setting is "ON").

Pressing the ● key again stops the data saving process. During automatic data saving measurement, data is displayed for one second each time a measurement takes place. When more than 999 data items are saved, data saving stops and "ERROR No. 0010" is displayed. When you delete the data, the error is cleared (refer to "Deleting all saved data" (page 47)).

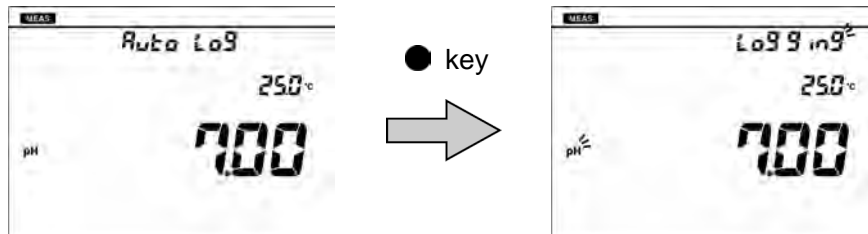

● Deleting all saved data

Delete all data saved in the internal memory. Data cannot be deleted selectively. Copy or transfer the data to a PC for storage if necessary.

1. Press the  key to enter the data mode.

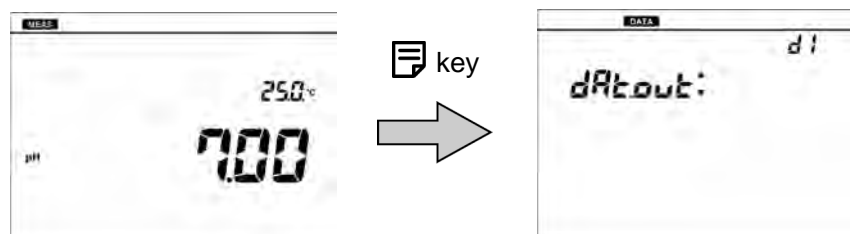

2. Press the ▲ ▼ keys to select "DAT.CLR" (delete saved data) and then press the ● key.
3. Select "YES" to delete the saved data, or select "NO" to cancel deleting it. And then press the ● key to confirm.
When "YES" is selected, "END" appears after deletion is complete.

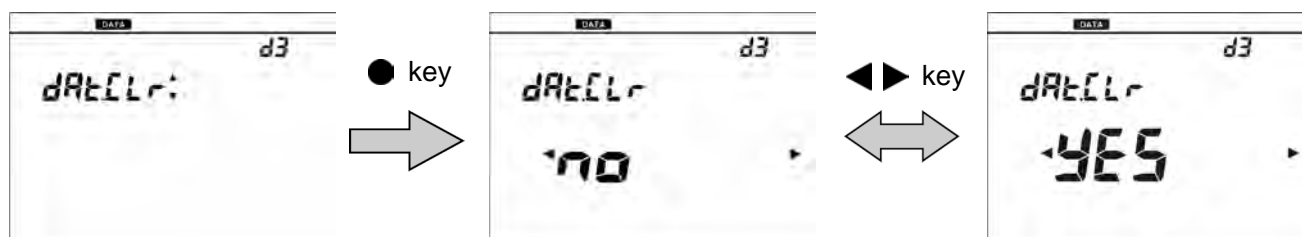

Selected "YES"
and press the
● key

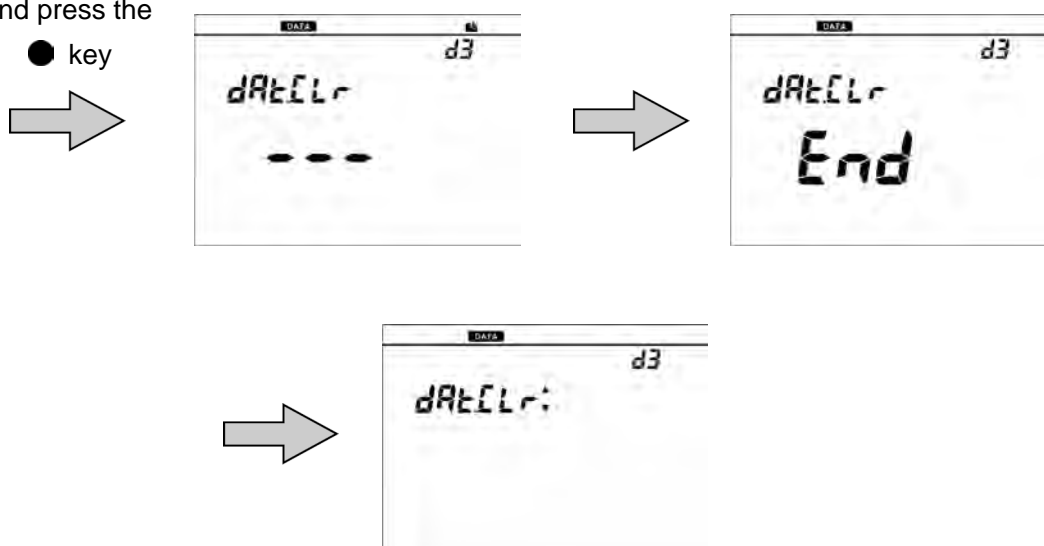







To return to the measurement mode, press the  key.

■ Measurement settings

● Displaying the latest calibration and inspection data

You can display the latest pH or ion calibration data and the repeatability inspection data (ion: LAQUA-PH1300 only).



1. Press the  key to enter the setting mode.
2. Press the   keys to select the component to confirm the data from "pH" or "ION" and then press the  key.
3. Press the   keys to select "CAL.DAT" (display calibration data) and then press the  key.

The electrode status based on the calibration result is displayed. You can change the display item among "OFS" (asymmetry potential), "SLP" (sensitivity), and "REP" (repeatability).

When pressing the  key, the calibration data is printed.

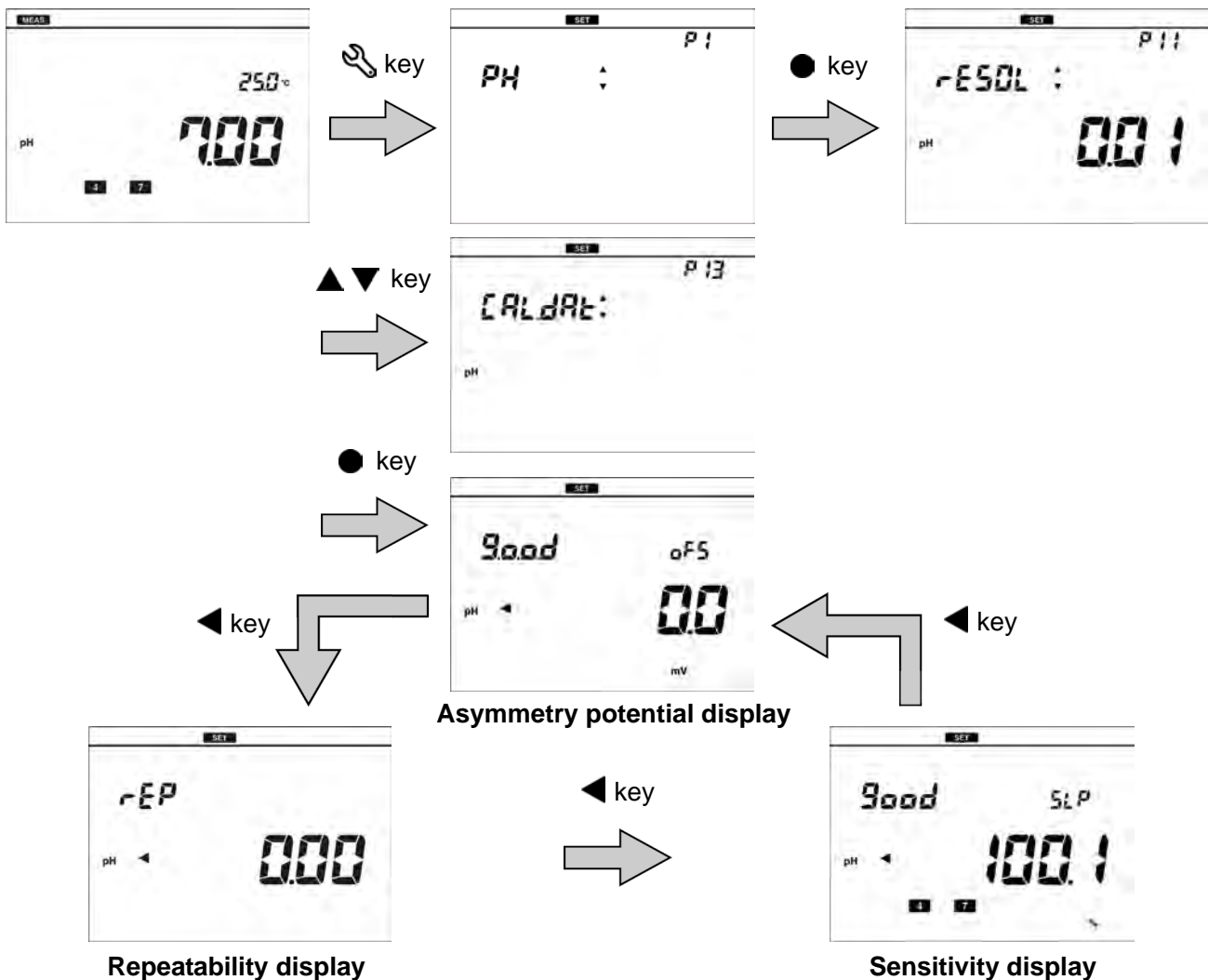
In the case of pH measurement



To return to the measurement mode, press the  key and then press the  key.

Tip





When multiple point calibration (more than two points) is performed, the results of multiple point calibration are displayed.

- Electrode status based on calibration result





Display	Description	Reference
GOOD	Electrode sensitivity: 85% to 105% Good condition.	—

● Using the calibration interval alarm (default: OFF)

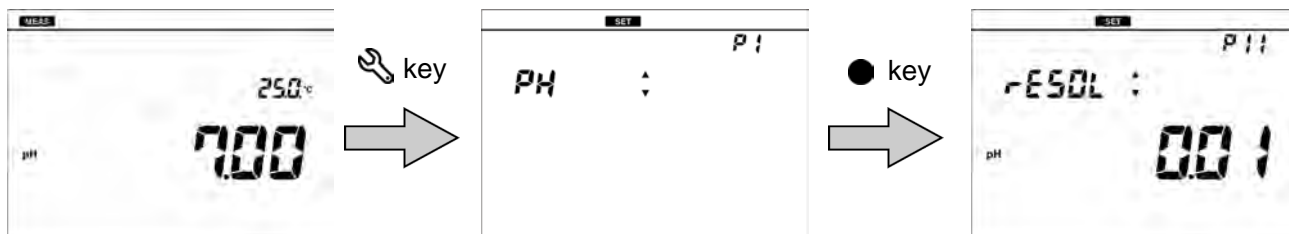
If the calibration has not been performed for set period of time after last calibration is performed, "ERROR No. 0008" is displayed to prevent forgetting to perform calibration. When the error is displayed, performing calibration clears the error.

1. Press the  key to enter the setting mode.
2. Press the   keys to select "pH" (pH setting) and then press the  key.





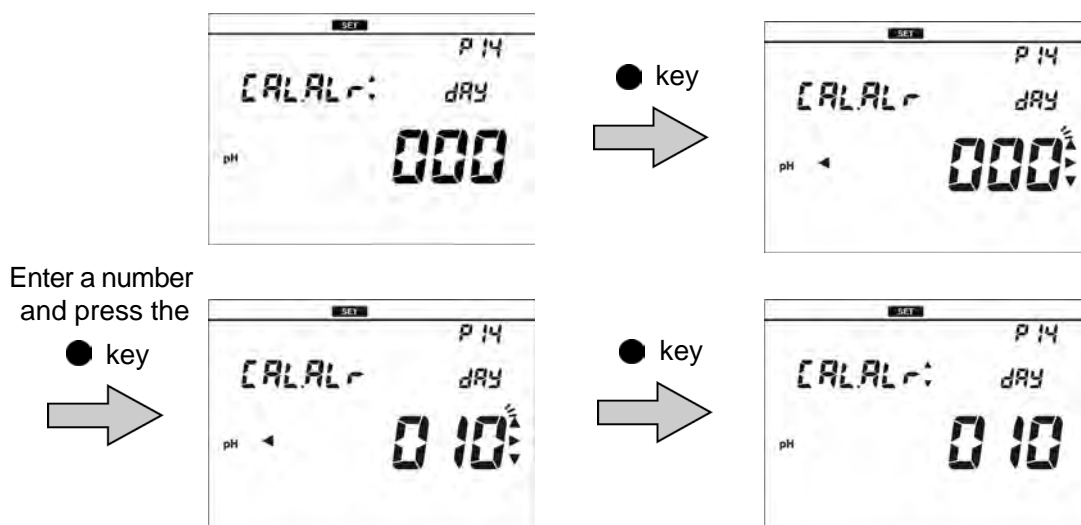

3. Press the   keys to select "CAL.AL" (calibration alarm setting) and then press the  key.
4. Enter the setting period of the calibration interval alarm and then press the  key to confirm.
The setting range is 1 day to 400 days.



To return to the measurement mode, press the  key.

● Deleting calibration data

Delete the calibration data set in the instrument.

1. Press the  key to enter the setting mode.
2. Press the   keys to select the component to confirm the data from "pH" or "ION" and then press the  key.

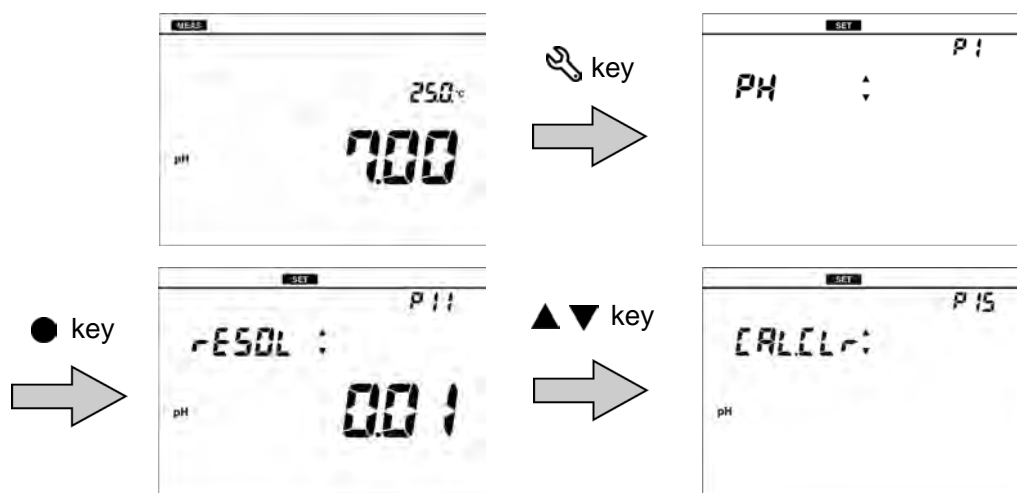

3. Press the   keys to select "CAL.CLR" (delete calibration data) and then press the  key.

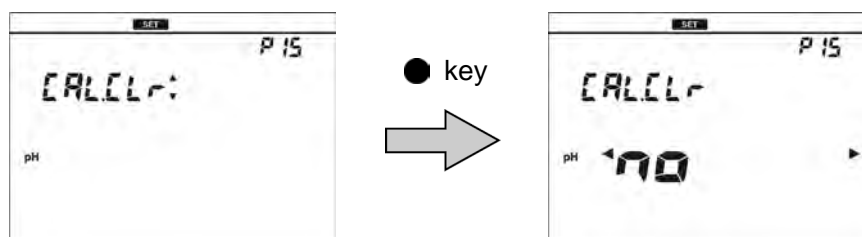

4. Select "YES" to delete the calibration data, or select "NO" to cancel deleting it. And then press the ● key to confirm selection.

When "YES" is selected and the ● key is pressed, "END" appears after deletion is complete. Press the ● key.

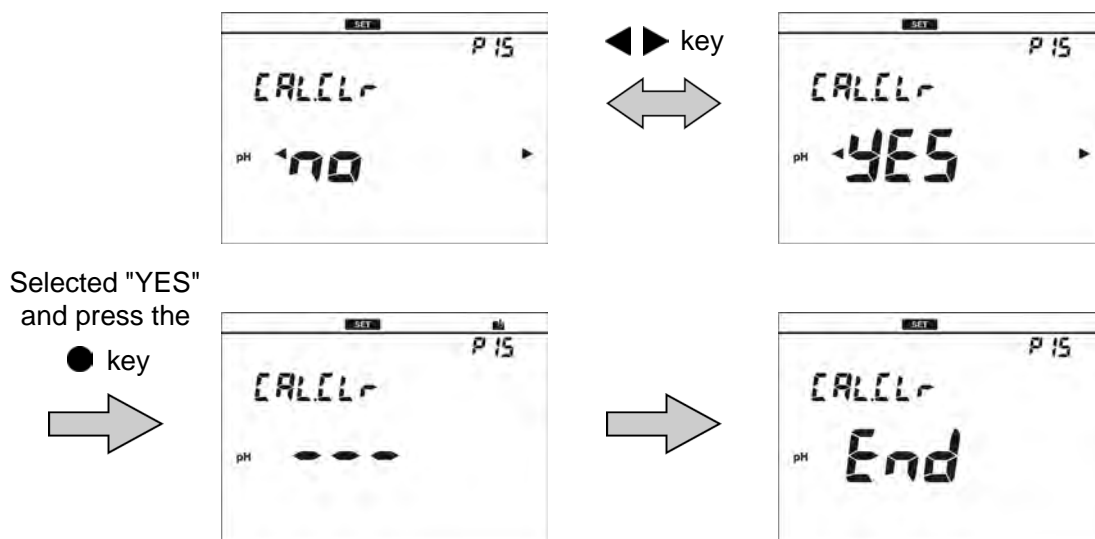

To return to the measurement mode, press the  key.





Tip

When the  key is pressed for more than three seconds in the measurement mode, "CAL.CLR" screen appears, and the calibration data can be deleted.



■ Temperature settings

● Calibrating temperature sensor

The temperature sensor or temperature compensation electrode in the combination electrode has $\pm 1^\circ\text{C}$ accuracy without calibration. You can use a known temperature solution to calibrate the temperature sensor.

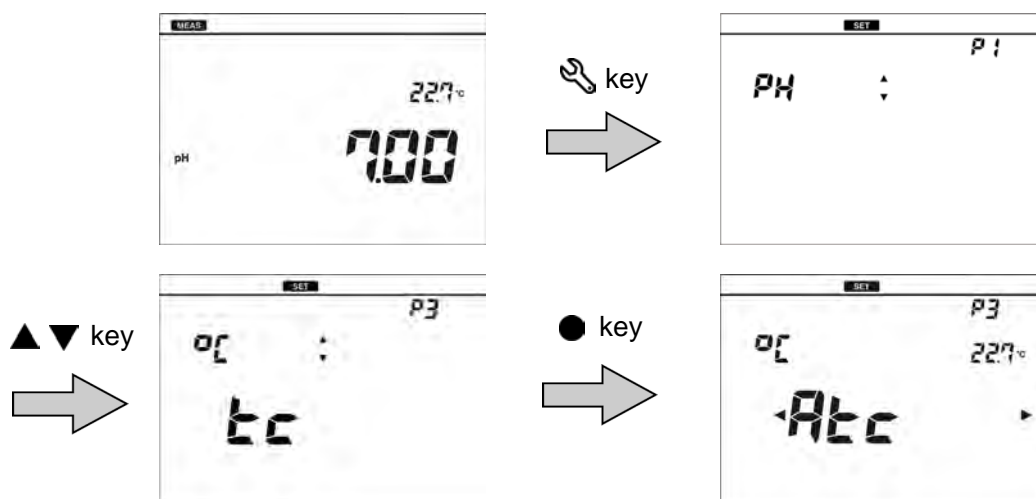
1. Insert the temperature connector into the jack of the CH1 temperature electrode (T).
2. Immerse the electrode into the solution until the temperature sensor is immersed.
3. Press the  key to enter the setting mode.
4. Press the   keys to select "TC" (temperature setting) and then press the  key.



5. Make sure that "ATC" is displayed, and press the  key.
The temperature setting screen appears.
6. Enter the set temperature and press the  key to confirm.
The temperature sensor is calibrated.

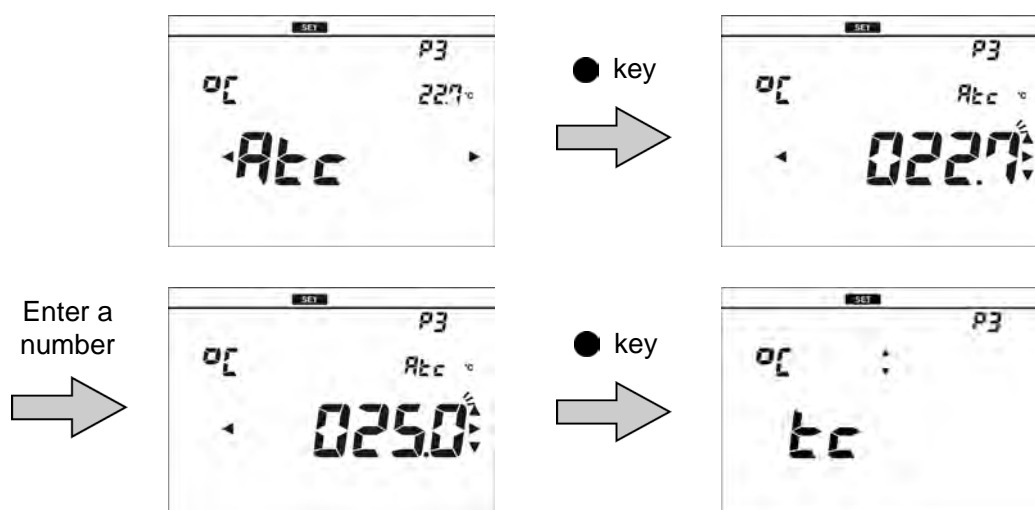

To return to the measurement mode, press the  key.

Note

When initializing temperature calibration data, all settings need to be initialized. Perform initialization by referring to “ Resetting to factory default settings ” (page 58). When initialization is performed, all saved data is deleted. Copy or transfer necessary data to a PC for storage.

■ General settings

● Setting the auto stability and auto hold function

This instrument has auto stability mode and auto hold mode.







• Auto stability mode (displayed as AS)

When the criterion for stability judgment is fulfilled during measurement, the component icon lights and the measured value is fixed. Once the value deviates from the stability judgment criterion, the measured value is released and displays instantaneous value.

• Auto hold mode (displayed as AH)

When the criterion for stability judgment is fulfilled during measurement, the component icon and the HOLD icon light and the measured value is fixed. To release the measured value, press the  key. Once a measured value is fixed, the measured value is not released automatically even when the state deviates from the stability judgment criterion.

• Setting procedure

1. Press the  key to enter the setting mode.
2. Press the   keys to select "GEN" (general setting) and then press the  key.
3. Press the   keys to select "MEAS" (measurement setting) and then press the  key.

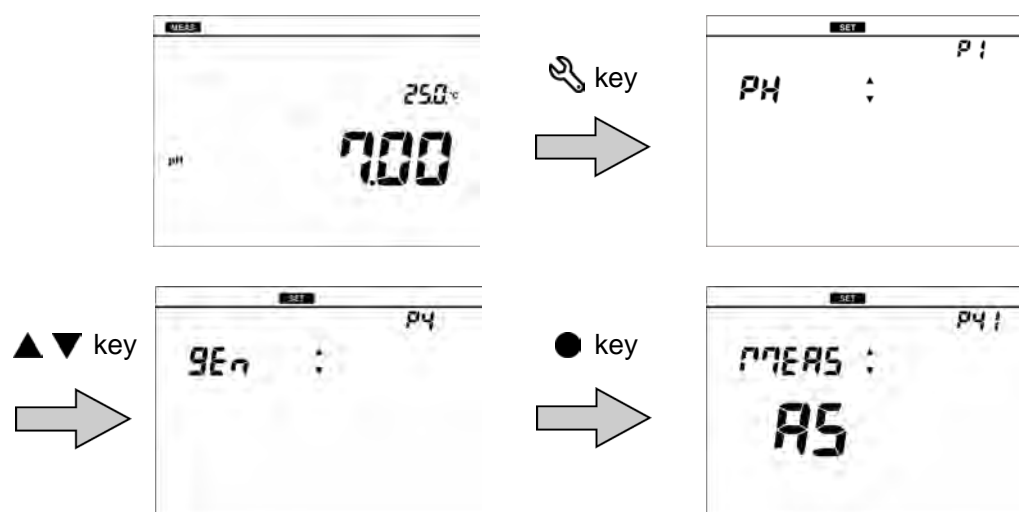

4. Select "AS" to set the auto stability, or select "AH" to set the auto hold. And then press the ● key to confirm selection.

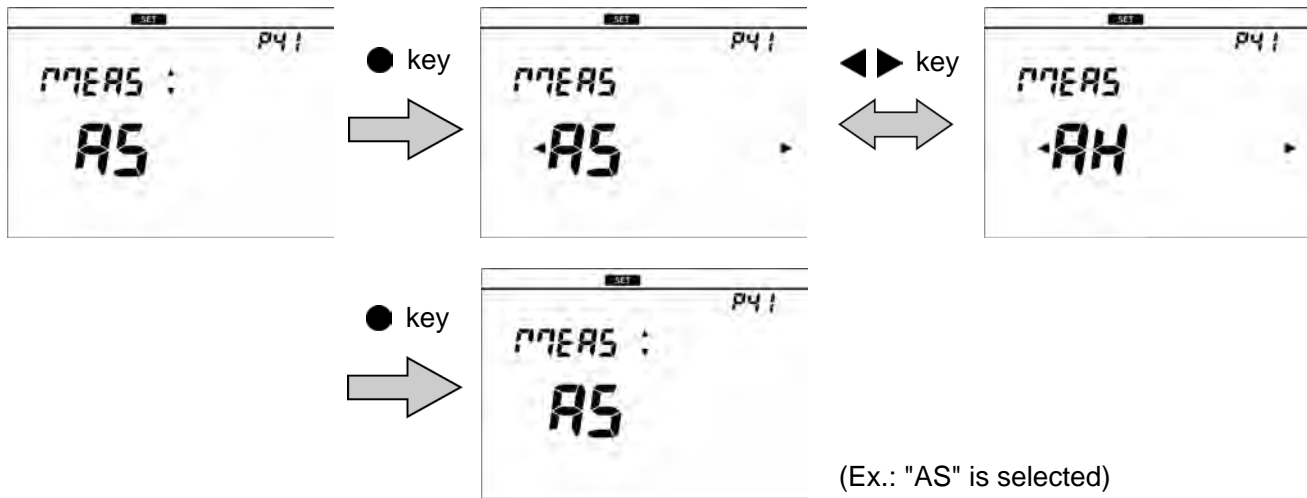

To return to the measurement mode, press the  key.

Note

In the calibration mode, the auto stability mode always works.

Tip

The stability judgment criteria is the same for both the auto stability mode and auto hold mode.

● Changing the automatic power off setting (default: 30 min)

You can set the instrument to automatically turn OFF when there is no key operation for a certain period of time.

This function is disabled during automatic data memory saving or remote operation using an external device.

This function is available for LAQUA-PH1200 and LAQUA-PH1300.

1. Press the  key to enter the setting mode.

2. Press the   keys to select "GEN" (general setting) and then press the  key.

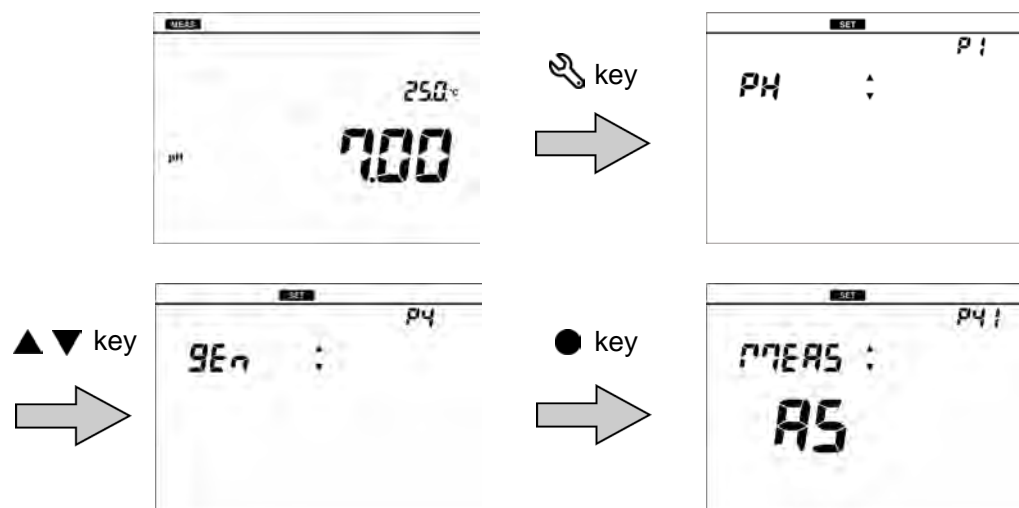

3. Press the   keys to select "AT. OFF" (automatic power off setting) and then press the  key.

4. Enter the automatic power off time and press the  key to confirm.

The setting range is 0 min to 30 min.



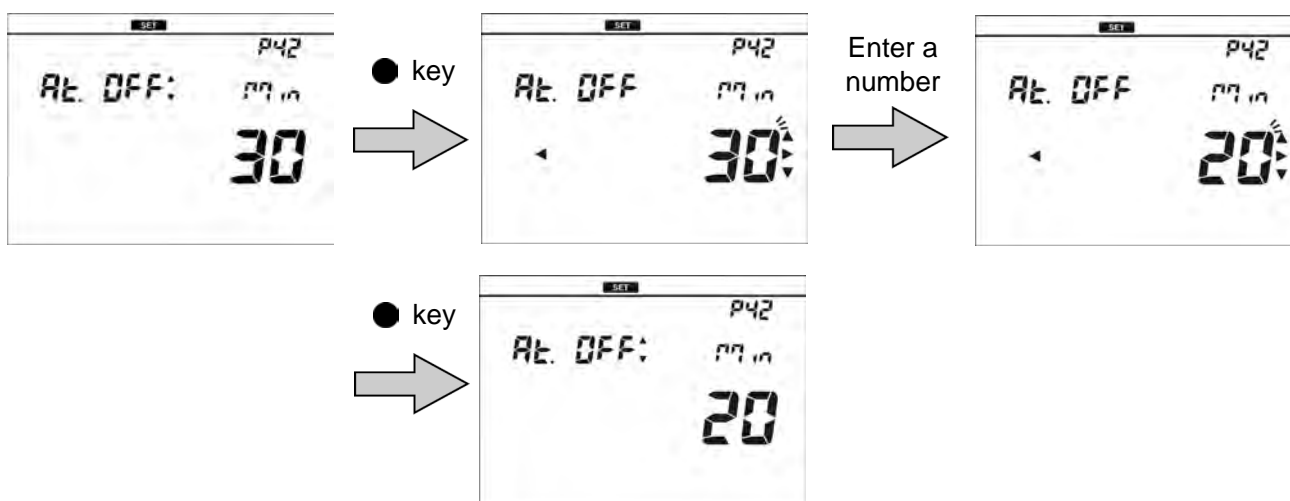

"0" indicates the automatic power off is "OFF."







To return to the measurement mode, press the  key.

● Resetting to factory default settings

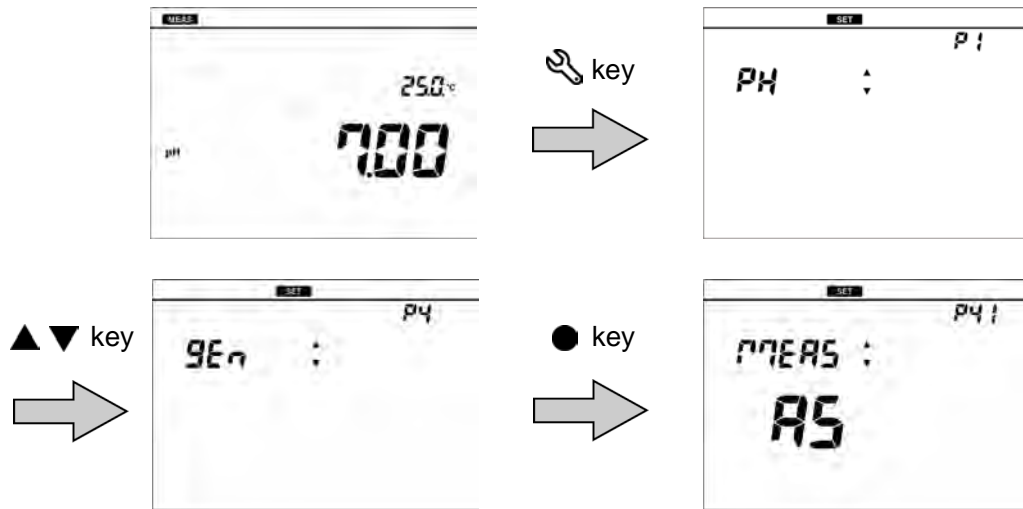
The instrument settings can be reset to the factory default settings. The calibration data and the saved data are deleted but the data of date and time are not deleted. Make sure there will be no problems before using this function. When this function is used, the temperature calibration data is also initialized.

1. Press the  key to enter the setting mode.
2. Press the   keys to select "GEN" (general setting) and then press the  key.



3. Press the   keys to select "RESET" (initialize) and then press the  key.
4. Select "YES" to initialize the settings to the factory default settings, or select "NO" to cancel initialization. And then press the  key to confirm selection. When "YES" is selected, "END" is displayed after the settings are initialized and then the instrument is automatically powered OFF.

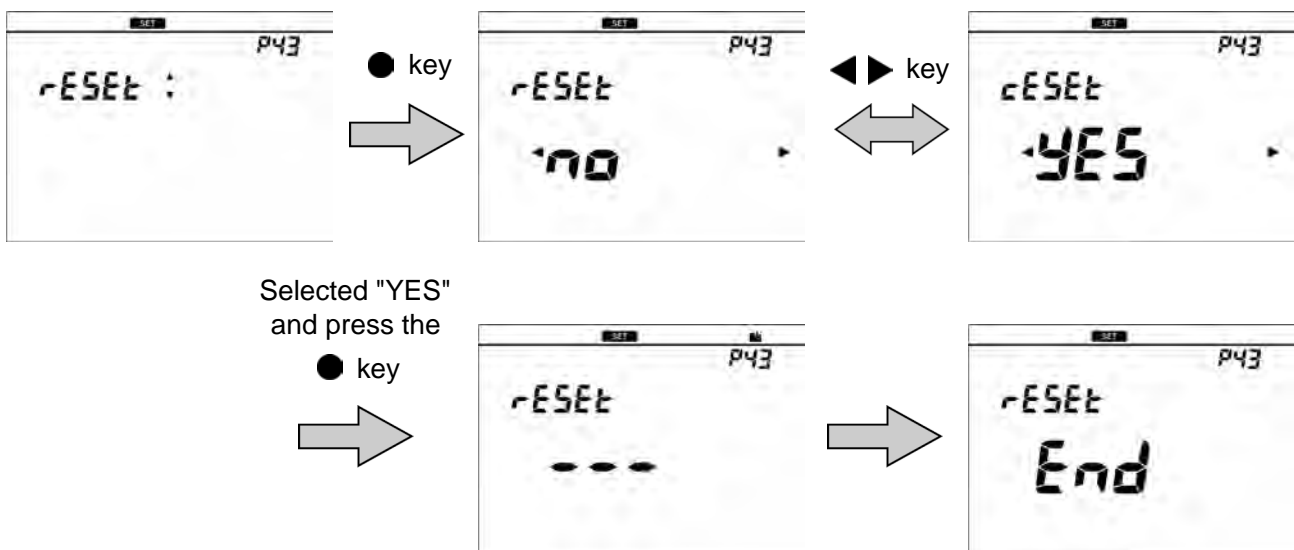

● Setting the date and time

When using the instrument for the first time, set the date and time. After setting, the date and time data is displayed correctly when saving data in the internal memory. If the setting is incorrect, the date and time of saved data becomes incorrect.

This function is available for LAQUA-PH1200 and LAQUA-PH1300.

1. Press the  key to enter the setting mode.

2. Press the   keys to select "GEN" (general setting) and then press the  key.

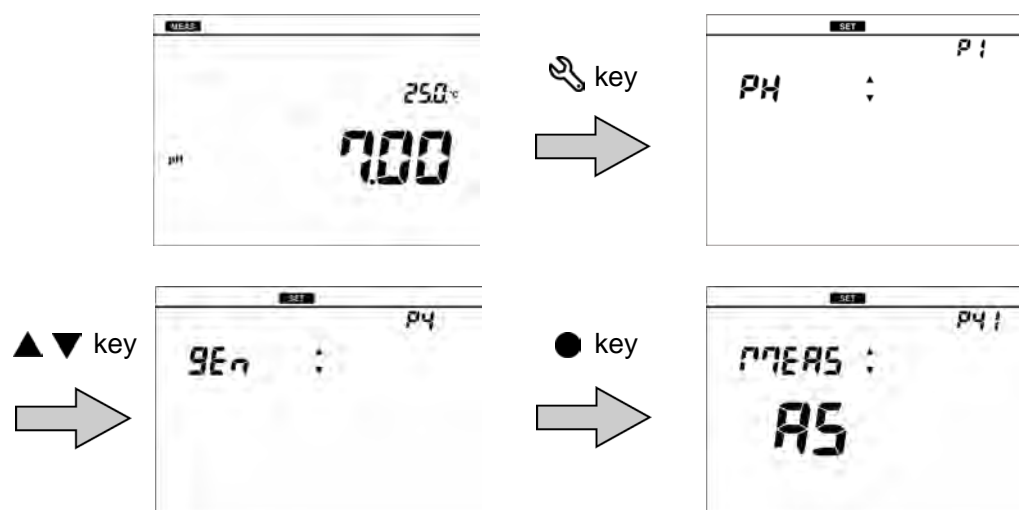

3. Press the ▲ ▼ keys to select "DATE" (date and time setting) and then press the ● key.
4. Set "YEAR" (current year) and press the ● key.
5. In the same way, set "MTH" (month), "DAY" (date), and "TIM" (hour and minute), in that order.
6. Press the ● key to confirm.

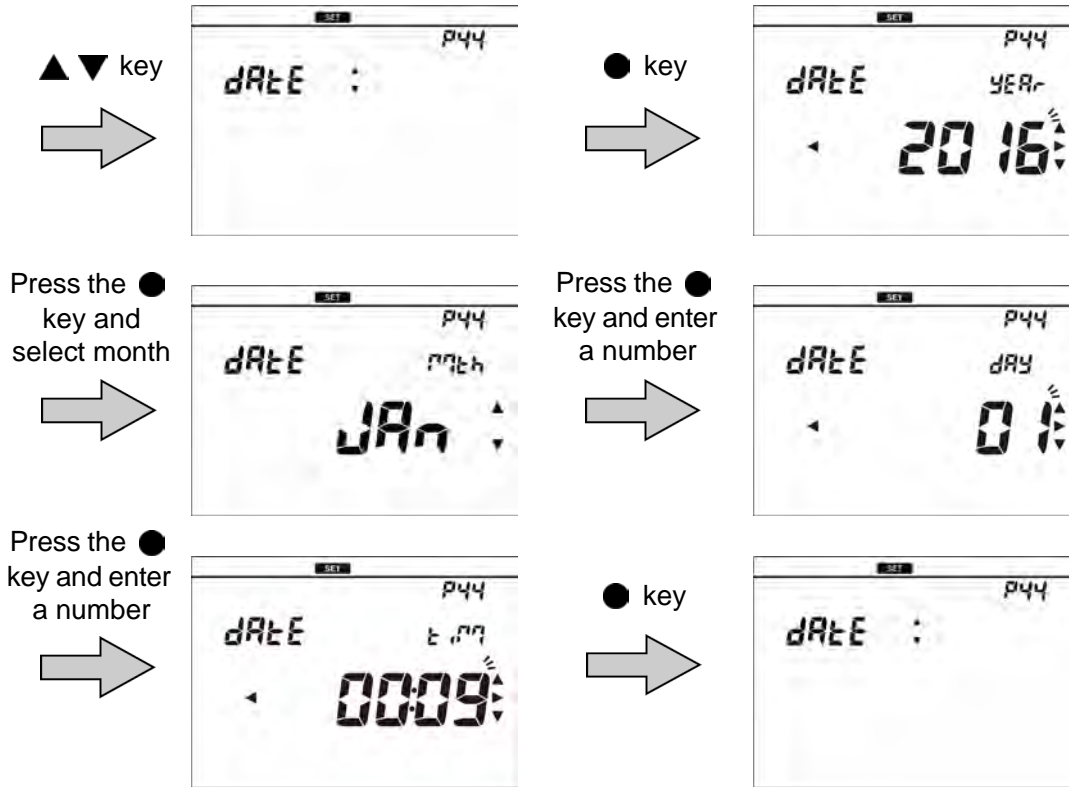

To return to the measurement mode, press the  key.





● Performing test printing of the printer unit

In order to check whether the printer unit is operating correctly or there is a printer communication problem, you can perform test printing.





Connect the instrument and a printer correctly and perform the following procedure for test printing. As a result of test printing, if the printout is as shown below, the printer unit is operating correctly.

```

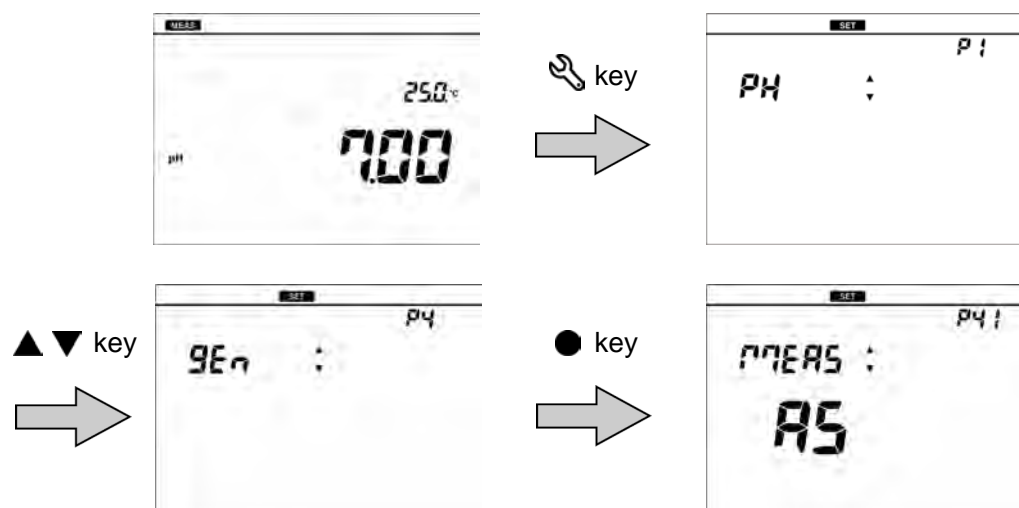
! " # $ % & ' ( ) * + , - . / 0 1 2 3
4 5 6 7 8 9 : ; < = > ? @ A B C D E F G
H I J K L M N O P Q R S T U V W X Y Z [
\ ] ^ _ ` a b c d e f g h i j k l m n o
p q r s t u v w x y z { | }
    
```

1. Press the  key to enter the setting mode.
2. Press the   keys to select "GEN" (general setting) and then press the  key.



3. Press the   keys to select "PRNT" (test print) and then press the  key. Printing starts automatically. When printing ends, the printer icon lights and "END" appears. Press the  key or  key.

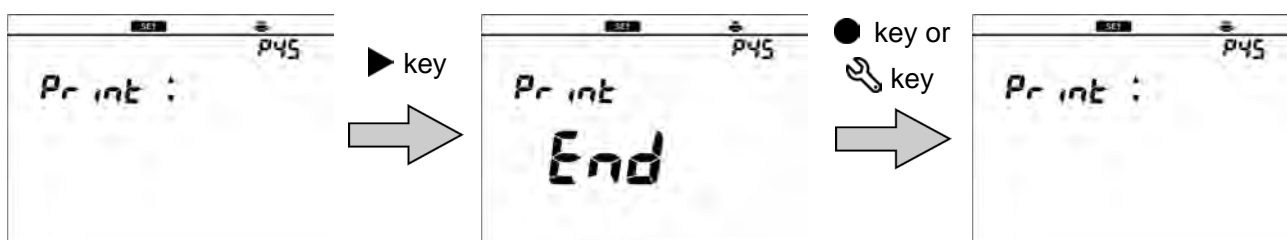

To return to the measurement mode, press the  key.

● Setting automatic print



When a printer is connected, you can enable automatic printing. When the setting is ON, printing is executed automatically under the following conditions.

- When data is saved during measurement
- When calibration or inspection is completed in the calibration screen

1. Press the  key to enter the setting mode.

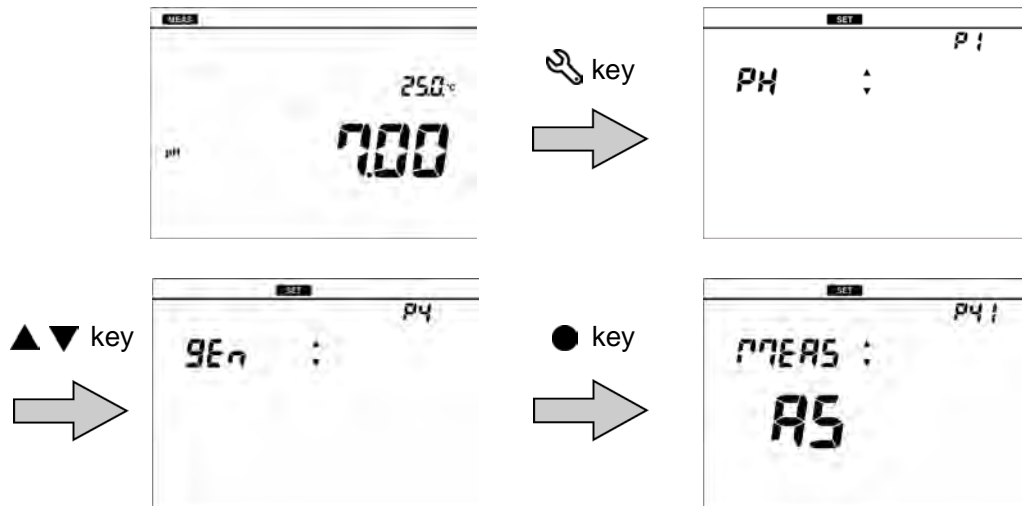
2. Press the   keys to select "GEN" (general setting) and then press the  key.



3. Press the   keys to select "AT. PRN" (automatic print setting) and then press the  key.



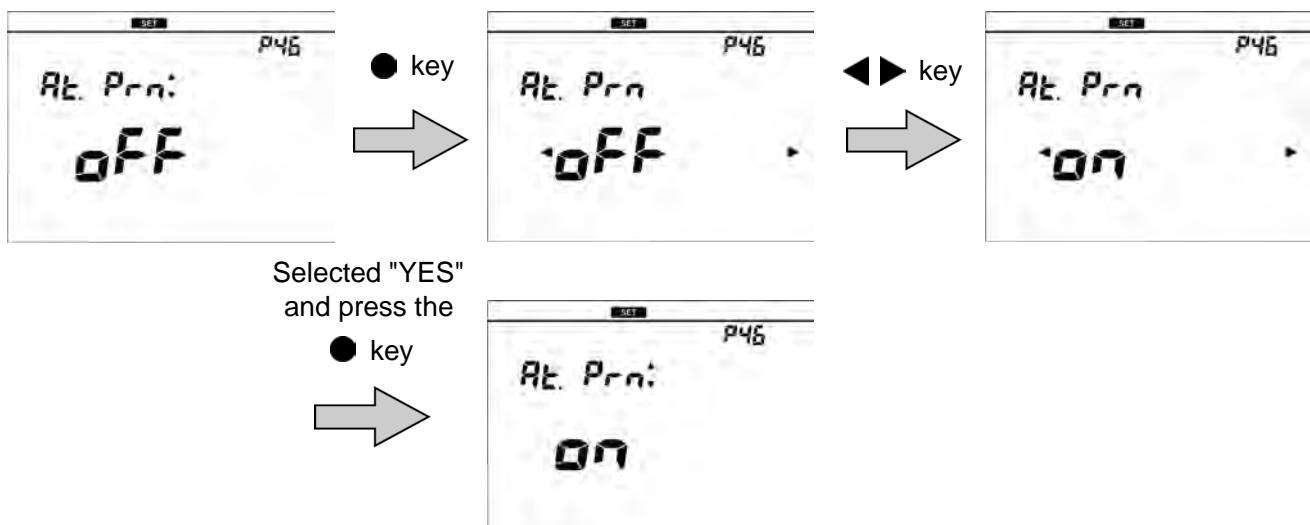

4. Select "ON" to use the function, or "OFF" to not use the function, and then press the  key to confirm selection.



To return to the measurement mode, press the  key.

● Setting password

Operation of the others can be prevented by setting password.

1. Press the  key to enter the setting mode.
2. Press the   key to select "GEN" (general setting) and then press the  key.

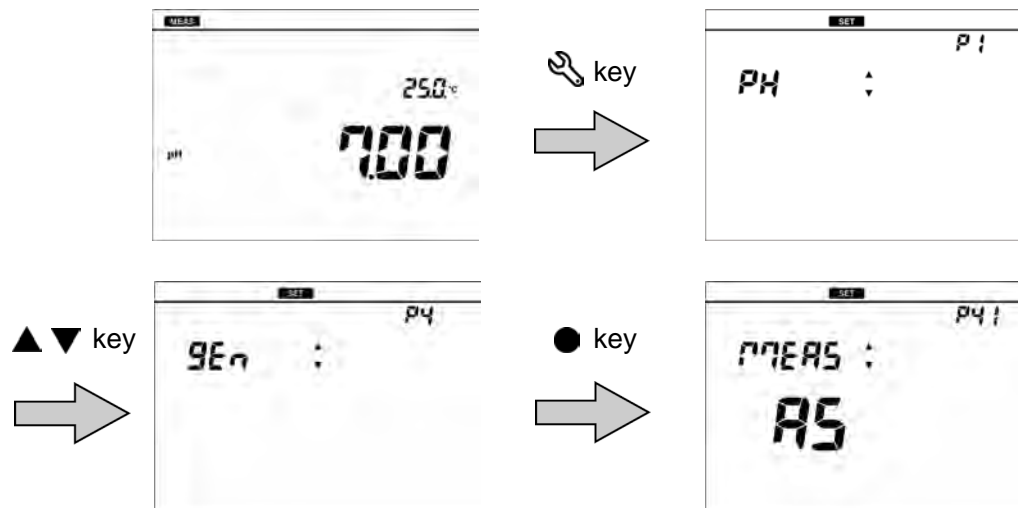

3. Press the ▲▼ keys to select "PASS" (password) and then press the ● key.
4. Enter a 4-digit number and press the ● key to confirm.

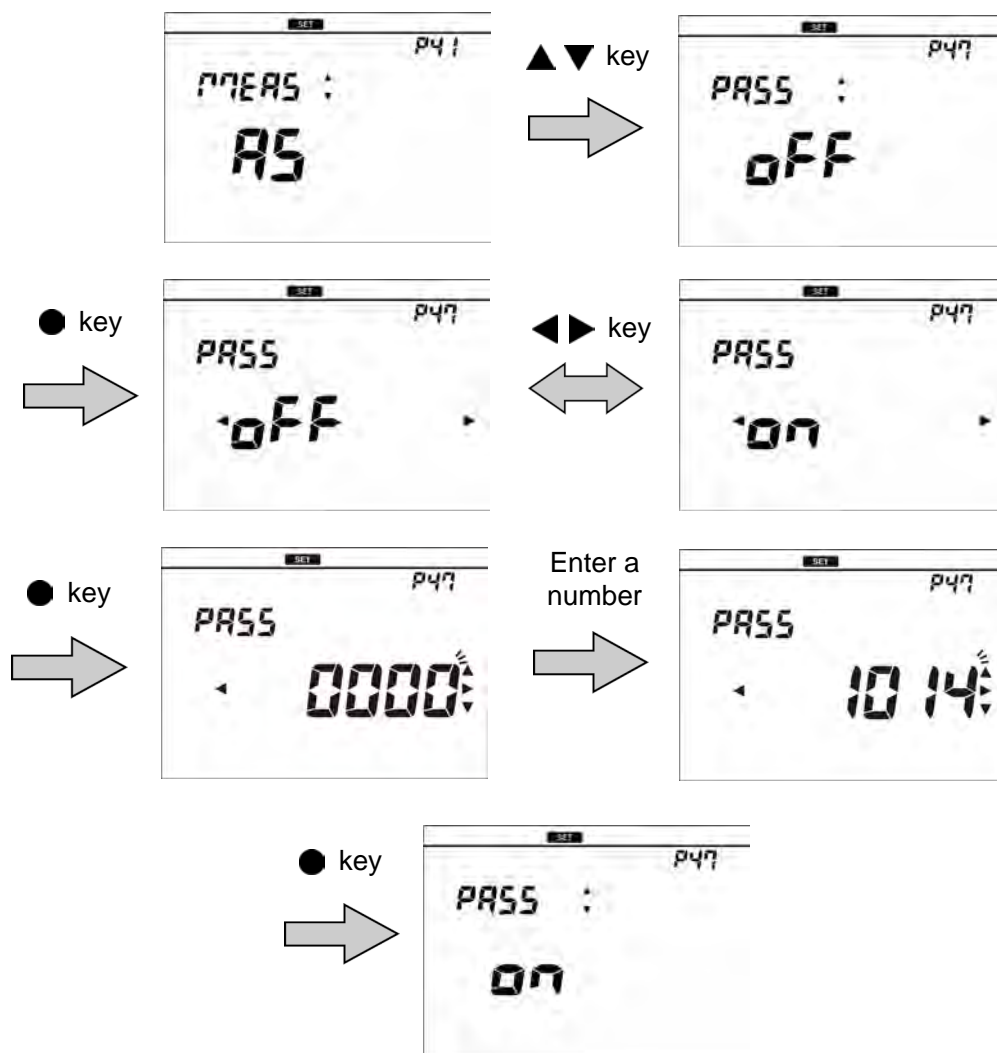

To return to the measurement mode, press the  key.

■ Other settings

● Printing measured values and calibration data

Print out the measured value or the calibrated value displayed on the instrument, or the measurement data or the calibration data saved in the instrument. If the repeatability is inspected, the inspection data is printed out with the calibration data.

Pressing the ► key starts printing during displaying the data you want to print. Use the printer cable to connect the printer unit with the instrument beforehand. If the automatic data memory is set to "ON", you cannot print out in the measurement mode.

Reference

For details of how to display measurement data and calibration data, refer to the respective section.

“ Setting the date and time ” (page 59)

“ Displaying the latest calibration and inspection data ” (page 48)

Refer to the following table for the pH (two point calibration) and ion concentration (two point calibration).

Other settings

< Measurement data (pH)>

Printout format	Description
Date : 2016/01/01	Measurement date
Time : 09 : 00	Measurement time
pH : 5.22	Measured value (Outside the display range: "UR" or "OR")
HOLD : HOLD	HOLD status Hold value: HOLD Not hold value: INST
Temperature : 25.5°C ATC	Temperature value and temperature setting
Inst. model : LAQUA-PH1300	Instrument model
Inst. SN : KL1TSE10	Instrument serial number
Elect. status : OK	Electrode status based on calibration result
Offset : 0.7 mV	Asymmetry potential of calibration data
Sensitivity	Sensitivity of calibration data
pH 4.01 - 6.86 : 98.9%	

< Measurement data (ion)>

Printout format	Description
Date : 2016/01/01	Measurement date
Time : 09 : 00	Measurement time
ION : 62.5 mg/L	Measured value
HOLD : HOLD	HOLD status Hold value: HOLD Not hold value: INST
Temperature : 25.5°C ATC	Temperature value (outside the display range: "UR" or "OR") and temperature setting
Inst. model : LAQUA-PH1300	Instrument model
Inst. SN : KL1TSE10	Instrument serial number
Elect. status : OK	Electrode status based on calibration result
Sensitivity	Sensitivity of calibration data
1000 mg/L–100 mg/L	
: 99.9%	

< The data saved in internal memory (pH)>

Printout format	Description
Memory Num : 0001	Data number
Date : 2016/01/01	Measurement date
Time : 09 : 00	Measurement time
pH : 5.22	Measured value (Outside the display range: "UR" or "OR")
HOLD : INST	HOLD status Hold value: HOLD Not hold value: INST
Temperature : 25.0°C MTC	Temperature value (Outside the display range: "UR" or "OR") and temperature setting
Inst. model : LAQUA-PH1300	Instrument model
Inst. SN : KL1TSE10	Instrument serial number
Elect. status : OK	Electrode status based on calibration result

< The data saved in internal memory (ion)>

Printout format	Description
Memory Num : 0001	Data number
Date : 2016/01/01	Measurement date
Time : 09 : 00	Measurement time
ION : 62.5 mg/L	Measured value
HOLD : INST	HOLD status Hold value: HOLD Not hold value: INST
Temperature : 25.0°C MTC	Temperature value and temperature setting
Inst. model : LAQUA-PH1300	Instrument model
Inst. SN : KL1TSE10	Instrument serial number
Elect. status : OK	Electrode status based on calibration result

Other settings

< Calibration data (pH, inspection was performed) >

Printout format	Description
Inst. model : LAQUA-PH1300	Instrument model
Inst. SN : KL1TSE10	Instrument serial number
Elect. status : OK	Electrode status based on calibration result
Offset : 0.7 mV	Asymmetry potential of calibration data
Sensitivity	Sensitivity of calibration data
pH 4.01 - 6.86 : 98.9%	
Repeatability : 0.01	Repeatability of calibration data
Calibration data	
Date : 2016/01/01	Calibration date
Time : 09 : 00	Calibration time
pH 4.01 : 176.9 mV	Measurement potential
: 25.0°C ATC	Temperature value and temperature setting
pH 6.86 : 7.6 mV	Measurement potential
: 25.1°C ATC	Temperature value and temperature setting
Inspection before use	
pH 6.85 : 7.8 mV	Measurement potential at time of repeatability inspection
: 25.1°C ATC	Temperature value and temperature setting

< Calibration data (pH, inspection was not performed) >

Printout format	Description
Inst. model : LAQUA-PH1300	Instrument model
Inst. SN : KL1TSE10	Instrument serial number
Elect. status : OK	Electrode status based on calibration result
Offset : 0.7 mV	Asymmetry potential of calibration data
Sensitivity	Sensitivity of calibration data
pH 4.01 - 6.86 : 98.9%	
Calibration data	
Date : 2016/01/01	Calibration date
Time : 09 : 00	Calibration time
pH 4.01 : 176.9 mV	Measurement potential
: 25.0°C ATC	Temperature value and temperature setting
pH 6.86 : 7.6 mV	Measurement potential
: 25.1°C ATC	Temperature value and temperature setting

< Calibration data (ion) >

Printout format	Description
Inst. model : LAQUA-PH1300	Instrument model
Inst. SN : KL1TSE10	Instrument serial number
Elect. status : OK	Electrode status based on calibration result
Sensitivity	Sensitivity of calibration data
1000 mg/L–0.001 mg/L	
: 99.9%	
Calibration data	
Date : 2016/01/01	Calibration date
Time : 09 : 00	Calibration time
1000 mg/L : 241.2 mV	Measurement potential
: 25.0°C ATC	Temperature value and temperature setting
0.001 mg/L : 0.1 mV	Measurement potential
: 25.1°C ATC	Temperature value and temperature setting

● Transferring saved data to a PC

By using a serial cable or USB cable to connect the instrument to a PC, you can transfer the saved data to the PC and edit it (LAQUA-PH1200 and LAQUA-PH1300 only). Connect the RS-232C connector at the instrument side to the serial port on the PC or connect the USB connector at the instrument side to the USB port on the PC.

To save and edit data, please download the software "FD-70" from our website after the registration.

For details of how to use the "FD-70", refer to the "FD-70" instruction manual, which you can download from our website as well.

The required PC specifications and recommended PC specifications for using the "FD-70" are shown in the following table.

Item	Required PC specifications	Recommended PC specifications
Memory	256 MB or more	512 MB or more
CPU	1 GHz or more	1.6 GHz or more
HDD free space	5 GB or more	10 GB or more
OS	Windows XP (SP3), Windows Vista, Windows 7, Windows 8, or Windows 10	
Display	Super VGA (800 × 600) or more	
Connector	Serial connector (D-Sub 9 pin)	

Note

- If you are not using the RS-232C or USB communication, close the connector cover tightly.
- While using the RS-232C or USB communication, the instrument is not dust-proof. Do not use the RS-232C or USB communication in a dusty place or with wet hands.

● Operating the instrument from an external device

You can remotely operate the instrument from an external device (such as PC) via RS-232C communication (LAQUA-PH1100, LAQUA-PH1200, LAQUA-PH1300) or USB communication (LAQUA-PH1200, LAQUA-PH1300). Use a serial cable or a USB cable to connect the RS-232C connector or the USB connector on the instrument and the serial port or the USB port on the PC.

When using this function, pay attention to the following points.

- Use the optional serial cable or USB cable to connect the unit to a PC.
- Make sure that the transfer formats used in the instrument and a PC are the same. When different transfer formats are used, a communication error occurs and the online mode does not start up, and as a result RS-232C communication cannot be performed. Also, when the transfer format is changed, turn OFF the power of the instrument and PC and then reboot them.

The transfer format of the instrument is as follows.

- Baud rate: 2400 bps
- Character length: 8 bits
- Parity: None
- Stop bit: 1 bit

You can download a list of communication commands from our website. In order to download the list, you need to complete user registration.

Note

- If you are not using the RS-232C or USB communication, close the connector cover tightly.
 - While using the RS-232C or USB communication, the instrument is not dust-proof. Do not use the RS-232C or USB communication in a dusty place or with wet hands.
-

MEMO



Maintenance

This section describes maintenance of the instrument and the electrodes that are used with the instrument. To use them for a long period, perform the described maintenance procedures appropriately.

● Contact for maintenance

Please contact your dealer for the product maintenance.

● Maintenance and storage of the instrument

- If the instrument becomes dirty, wipe it gently with a soft dry cloth. If it is difficult to remove the dirt, wipe it gently with a cloth moistened with alcohol.
- The instrument is made of solvent resistant materials but that does not mean it is resistant to all chemicals. Do not dip the instrument in strong acid or alkali solution, or wipe it with such solution.
- Do not wipe the instrument with a polishing powder or other abrasive compound.

● Environmental conditions for storage

Temperature: 0°C to 45°C

Humidity: under 80% in relative humidity and free from condensation

Avoid the following conditions.

- Dusty place
- Strong vibration
- Direct sunlight
- Corrosive gas environment
- Close to an air-conditioner
- Direct wind

● Maintenance and storage of the pH electrode

For the detailed procedures for maintaining and storing electrodes, refer to the instruction manual for each electrode. This section describes an overview of the procedures for maintenance and storage to be performed as part of daily use.

• How to clean the electrode

When the tip of an electrode (responsive membrane and liquid junction) becomes dirty, the response speed may become slow or an error may occur in the measurement results. To avoid such error, clean the electrode. For dirt that cannot be removed by pure water (or deionized water), use the cleaning solution indicated below depending on the type of dirt. After cleaning, rinse the electrode with pure water (or deionized water).

Type of dirt	Cleaning solution
General	Diluted neutral cleaning solution
Oil	Alcohol, or diluted neutral cleaning solution
Inorganic substance	1 mol/L HCl or electrode cleaning solution (model 220)
Protein	Cleaning solution including protein-removing enzyme (model 250)
Alkaline	Immerse 1 mol/L HCl or electrode cleaning solution (model 220) in 1 h to 2 h

• Daily storage of the electrode

If the electrode becomes dry, the response will become slow. Store in a moist atmosphere. Follow the steps below to properly store the electrode.

1. Clean the electrode well with pure water (or deionized water) to remove sample completely, and close the internal solution filler port.
2. Clean inside of the protective cap with pure water (or deionized water), then add enough pure water (or deionized water) to soak the sponge.
3. Attach the protective cap.

• When the electrode will not be used for a long period

To store the electrode for a long period, follow the electrode storage procedure above, and in addition, use a dropper or similar tool to replace the reference electrode internal solution (model 300) with new solution. Replace the internal solution once every three to six months.

● Maintenance and storage of the ORP electrode

For the detailed procedures for maintaining and storing electrodes, refer to the instruction manual for each electrode. This section describes an overview of the procedures for maintenance and storage to be performed as part of daily use.

• How to clean the electrode

When the tip of an electrode (responsive membrane and liquid junction) becomes dirty, the response speed may become slow or an error may occur in the measurement results. To avoid such error, clean the electrode. For dirt that cannot be removed by pure water (or deionized water), use the cleaning solution indicated below depending on the type of dirt. After cleaning, rinse the electrode with pure water (or deionized water).

Type of dirt	Cleaning solution
General	Diluted neutral cleaning solution
Oil	
Inorganic substance	Immerse dilute nitric acid (1:1 nitric acid)

• Daily storage of the electrode

If the electrode becomes dry, the response will become slow. Store in a moist atmosphere. Follow the steps below to properly store the electrode.

1. Clean the electrode well with pure water (or deionized water) to remove sample completely, and close the internal solution filler port.
2. Clean inside of the protective cap with pure water (or deionized water), then add enough pure water (or deionized water) to soak the sponge.
3. Attach the protective cap.

• When the electrode will not be used for a long period

To store the electrode for a long period, follow the electrode storage procedure above, and in addition, use a dropper or similar tool to replace the reference electrode internal solution (model 300) with new solution. Replace the internal solution once every three to six months.

● Checking the state of the ORP electrode

ORP standard solution can be used to check the state of the ORP electrode. This solution is only used to check the state of the ORP electrode; it is not used to calibrate the instrument. The procedure for checking the electrode using HORIBA ORP standard solution powder 160-22 or 160-51 is explained below.

1. Add one bag of 160-22 or 160-51 standard solution powder to 250 mL of deionized water and mix thoroughly.

When mixing, the excess quinhydrone (a black powder) will float to the surface of the solution.

2. Immerse a cleaned and dried ORP electrode in the prepared standard solution and measure the mV value.

If the electrode and the instrument are working properly, numerical values within ± 15 mV of those indicated below should be obtained.

The ORP value varies by temperature. Check the appropriate ORP value for the temperature of the standard solution.

3. If the ORP value is not within ± 15 mV, replace the reference electrode internal solution.

If the surface of the metal electrode is dirty, wipe it gently with a soft material such as absorbent cotton moistened with alcohol or a neutral cleaning solution, or immerse in dilute nitric acid (1:1 nitric acid) to remove the dirt.

4. Repeat the measurement.

If the ORP value is within ± 15 mV, the electrode is normal.

If not within ± 15 mV, the electrode may have failed. Replace the electrode.

Note

- If the prepared standard solution is left out in air for one hour or more, that the ORP value might change. Do not use the ORP standard solution that was prepared more than one hour before.
- When measuring a solution that has low concentrations of oxidants and reductants after conducting an operational check using a standard substance, the measured values may not stabilize or the repeatability might be poor. If this is the case, use the ORP electrode after immersing it in the solution again and mixing it thoroughly.

• ORP value based on the temperature of ORP standard solution

Temp. (°C)	160-22 Phthalic-acid chloride + quinhydrone (mV)	160-51 Neutral phosphate + quinhydrone (mV)
5	274.2	111.9
10	270.9	106.9
15	266.8	101.0
20	262.5	95.0
25	257.6	89.0
30	253.5	82.7
35	248.6	76.2
40	243.6	69.0

● Maintenance and storage of the ion electrode

For the detailed procedures for maintaining and storing electrodes, refer to the instruction manual for each electrode. This section describes an overview of the procedures for maintenance and storage to be performed as part of daily use.

• Daily storage of the electrode

While the electrode is stored, the concentration of the reference internal solution (outer tube) may change. For this reason, replace the reference internal solution (outer tube) with a dropper or similar tool about once a week to once a month.

When storing the electrode, immerse it in the solution indicated below depending on the electrode type.

ion	Conditioning solution
Cl^-	Pure water (or deionized water)
F^-	Pure water (or deionized water)
NO_3	1 mol/L potassium nitrate solution (100 g/L KNO_3)
K^+	0.1 mol/L potassium chloride solution (7.5 g/L KCl)
Ca^{2+}	Tap water
NH_3	0.01 mol/L ammonium chloride solution

• When the electrode will not be used for a long period

To store the electrode for a long period, follow the electrode storage procedure below.

1. Remove the electrode tip from the electrode and put the rubber cap.
2. Put the protective cap on the electrode. Be sure to keep the protective cap dry.
3. Store both the electrode tip and the electrode in a dry place.

Note

Before reuse, condition the electrode as indicated in “ Ion concentration measurement ” (page 31).

MEMO



How to Resolve Errors or Troubles

This section describes the causes of typical problems and the actions to be taken, including questions frequently asked by customers. Check these before contacting us.

■ When an error message appears

If "ERROR No.00XX" is displayed while you are using the instrument, check the error in the error list below to check the cause and action to be taken.

ERROR No.	Description	Definition of error
0001	Memory error	Data cannot be read from or written to the internal memory.
0004	Asymmetric potential error	The asymmetric potential of the electrode is out of the range of ± 45 mV.
0005	Electrode sensitivity error	The electrode sensitivity is either 105% or more or 85% or less than the theoretical sensitivity.
0006	Maximum calibration points exceeded	6th point calibration is attempted.
0007	Cannot identify standard solution	The instrument cannot identify the standard solution.
0008	Calibration interval error	Exceeds the calibration interval setting.
0009	Printer error	There is a problem with the printer.
0010	Memory full	The number of the data saved has exceeded the limit of the internal memory.

● ERROR No.0001 Memory error

Data cannot be read from or written to the internal memory.

Cause	How to solve problem
The instrument does not start properly due to noise or other at power ON.	Disconnect the AC adapter, and then press the  key.
The defect of the internal IC	Contact your dealer for repair.

● ERROR No.0004 Asymmetric potential error

Detected that the asymmetric potential of the electrode is out of the setting range that allows proper measurement.

Cause	How to solve problem
The electrode is dirty.	Clean the electrode.
The electrode is cracked.	Replace the electrode.
The standard solution concentration is fluctuating.	Replace the internal solution in the reference electrode.
The electrode is not connected correctly.	Connect the electrode correctly.
Electrode is not immersed enough to cover liquid junction.	The electrode must be immersed up to the liquid junction. As a guide, immerse to at least 3 cm from the tip of the electrode.
There is a problem with the standard solution.	Use new standard solution.

● ERROR No.0005 Electrode sensitivity error

Detected that the electrode sensitivity is out of the setting range that allows proper measurement.

Cause	How to solve problem
The electrode is dirty.	Clean the electrode.
The electrode is cracked.	Replace the electrode.
Calibration was not performed correctly.	Perform calibration correctly.
The electrode is not connected correctly.	Connect the electrode correctly.
Electrode is not immersed enough to cover liquid junction.	The electrode must be immersed up to the liquid junction. As a guide, immerse to at least 3 cm from the tip of the electrode.
There is a problem with the standard solution.	Use new standard solution.

● ERROR No.0006 Maximum calibration points exceeded

Attempted to perform 6th point calibration during pH and ion calibration.

Cause	How to solve problem
6th point calibration is attempted.	Up to five points can be calibrated.

● ERROR No.0007 Cannot identify standard solution

Unable to automatically detect the standard solution during pH calibration.

Cause	How to solve problem
There is a problem with the standard solution.	Use new standard solution.
Settings about the standard solution do not match the instrument.	Check if the instrument settings and the specifications of the standard solution are compatible.
The electrode is dirty.	Clean the electrode.
The electrode is cracked.	Replace the electrode.
The standard solution concentration is fluctuating.	Replace the internal solution in the reference electrode.
Electrode is not immersed enough to cover liquid junction.	The electrode must be immersed up to the liquid junction. As a guide, immerse to at least 3 cm from the tip of the electrode.

● ERROR No.0008 Calibration interval error

- More than the set number of days has elapsed since calibration was last performed.
- The calibration interval alarm is "ON" and calibration has not been performed.

Cause	How to solve problem
Calibration has not been performed for the set number of days of the calibration interval or longer.	Perform calibration.
The calibration interval alarm is "ON" and calibration has not been performed.	Perform calibration.

● ERROR No.0009 Printer error

An error occurred during printer communication.

Cause	How to solve problem
There is a problem with the printer unit connection.	Check the printer connection, and connect the instrument and printer again.
The defect of the printer	Consult your dealer.

● **ERROR No.0010 Memory full**

Attempted to save more than specified items of data.

Cause	How to solve problem
Saving more than specified items of data is attempted.	The maximum number of savable items of data is 500 (LAQUA-PH1100) or 999 (LAQUA-PH1200, LAQUA-PH1300). Copy or transfer necessary data to a PC and delete the data from the memory (refer to “Deleting all saved data” (page 47)).

■ Troubleshooting

This section describes causes and actions to take for problems that customers frequently ask us.

● The indicated value fluctuates

< Problem with the electrode >

Cause	How to solve problem
The electrode is dirty.	Clean the electrode.
The electrode is cracked.	Replace the electrode.
The wrong internal solution is being used.	Use the correct internal solution.
There are air bubbles on the electrode.	Shake the electrode to remove the air bubbles.
The level of internal solution in reference electrode is low.	Replenish the internal solution of the reference electrode until it is higher than the level of the sample.

< Problem with the instrument >

Cause	How to solve problem
There is a motor or other device causing electrical interference.	Measure at a place where no influence from induction is given. Ground all AC-powered equipment.
The electrode is not connected correctly.	Connect the electrode correctly.

< Problem with the sample >

Cause	How to solve problem
Electrode is not immersed enough to cover liquid junction.	The electrode must be immersed up to the liquid junction. As a guide, immerse to at least 3 cm from the tip of the electrode.
The stability of electrode is affected by the sample solution.	It is important to select an electrode that is appropriate for the sample. Consult your dealer. To confirm an electrode that is appropriate for the sample, check the pH electrode selection guide in our catalogue, or refer to our website.

● The response is slow

Cause	How to solve problem
The electrode is dirty.	Clean the electrode.
The electrode is cracked.	Replace the electrode.
The wrong internal solution is being used.	Use the correct internal solution.
The response of electrode is affected by the sample solution.	It is important to select an electrode that is appropriate for the sample. Consult your dealer. To confirm an electrode that is appropriate for the sample, check the pH electrode selection guide in our catalogue, or refer to our website.

● The indicated value does not change/No response

Cause	How to solve problem
The electrode is cracked.	Replace the electrode.
The electrode is not connected correctly.	Connect the electrode correctly.
The instrument is in HOLD state.	Cancel the HOLD state.
Instrument defect	Consult your dealer.

● The measured value is outside the display range

When the measured value is below the display range, "Ur" appears. When the measured value is over the display range, "Or" appears.

Cause	How to solve problem
Sample is out of the measurement range.	Use a sample within the measurement range.
Electrode is not immersed enough to cover liquid junction.	The electrode must be immersed up to the liquid junction. As a guide, immerse to at least 3 cm from the tip of the electrode.
The electrode cable is broken.	Replace the electrode.
Calibration is not performed or performed incorrectly.	Perform calibration correctly.
Instrument defect	Check as explained below.

• How to check for instrument defect

Short the metal part of the outer tube to the center pin of the electrode connector of the corresponding channel of the instrument. If "Ur" or "Or" appears in this condition, consult your dealer.

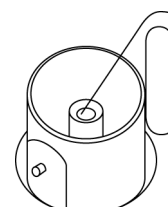

● Repeatability of the measured value is poor

Cause	How to solve problem
Effect of the sample solution	Repeatability becomes poor when the pH of the sample changes over time.
The electrode is dirty.	Clean the electrode. (Electrode cleaning solution 220 or 250 is recommended.)
The electrode is cracked.	Replace the electrode.
The internal solution of the electrode runs out or contaminated.	Replace the internal solution with new one.
The level of internal solution in reference electrode is low.	Replenish the internal solution of the reference electrode until it is higher than the level of the sample.

● Nothing appears when the power is turned ON

Cause	How to solve problem
Power is not supplied.	Connect the AC adapter.
Instrument defect	Consult your dealer.

● Part of the display is missing

Cause	How to solve problem
Instrument defect	Check the display in full screen state when turning ON the power of the instrument.

MEMO



Appendix

This section describes the specifications of the instrument, default settings, measurement principles, and other technical information.

Options for the instrument are also described.

■ Main specifications

Item	Description	
Model	LAQUA-PH1100, LAQUA-PH1200, LAQUA-PH1300	
Brand (pet name)	LAQUA	
Series name	Benchtop pH/Water Quality Analyzer	
Model description	Benchtop pH/ORP/ION Meter	
Measurement parameters	LAQUA-PH1100	pH, mV (ORP), temperature
	LAQUA-PH1200	pH, mV (ORP), temperature
	LAQUA-PH1300	pH, mV (ORP), ion concentration, temperature
Operating ambient temperature, humidity	0°C to 45°C 80% or less in relative humidity (no condensation)	
Power	AC adapter 100 V to 240 V, 50/60 Hz	
Dimensions	Approx. 170 (W) × 174 (D) × 73 (H) mm	
Mass	Approx. 500 g	

· Specification of each measurement parameter

Measurement parameter	Item	Description
pH	Measuring principle	Glass electrode
	Display range	pH -2.000 to pH 20.000
	Measuring range	pH 0.000 to pH 14.000
	Resolution	Selectable from 0.1 pH/0.01 pH/0.001pH (0.001 pH: LAQUA-PH1200 and LAQUA-PH1300 only)
	Accuracy	±0.003 pH (LAQUA-PH1100: ±0.01 pH)
	Repeatability	±0.002 pH (LAQUA-PH1100: ±0.01 pH)
mV (ORP)	Measuring range	±2000 mV
	Resolution	0.1 mV
	Accuracy	±0.2 mV
	Repeatability	±0.2 mV

Functions

Measurement parameter	Item	Description
Temperature	Measuring principle	Thermistor method
	Display range	-30.0°C to 130.0°C
	Measuring range	0.0°C to 100.0°C
	Resolution	0.1°C
	Accuracy	±0.4°C
	Repeatability	±0.2°C
Ion	Measuring principle	Ion electrode
	Measuring range (Display range)	0.000 to 9999 The unit is chosen from µg/L, mg/L, g/L, mmol/L, mol/L, and it's fixed.
	Resolution	Valid numbers 4 digits
	Accuracy	±0.3% of full scale
	Repeatability	±0.3% ±1 digit of full scale

Tip

Accuracy is the difference between the measured value and the simulation value when the simulation value is inputted to the instrument.

■ Functions

Item	LAQUA-PH1100	LAQUA-PH1200	LAQUA-PH1300
Clock	-	✓	✓
Memory number	500	999	999
Auto data memory	-	✓	✓
Printer connection	✓	✓	✓
PC connection	-	✓	✓

■ Instrument default settings

Measurement parameter	Item	Selection item/Setting range	Default values
Common	Auto hold	AS/AH	AS
	Temperature input value	0.0°C to 100.0°C	25.0°C
	Auto power off time* ¹	0 min to 30 min * ²	30 min
	Auto data memory time* ¹	0, 2 s to 3600 s * ³	2 s
	Auto data memory period* ¹	0 min to 3600 min	0 min
pH	Standard solution	USA/NIST/CUST	USA
	Calibration interval	0 day to 400 days * ⁴	1 day
Ion	Ion valency	-2/ -1/ 1/ 2	1
	Unit	μg/L, mg/L, g/L, mmol/L, mol/L	mg/L

*1: LAQUA-PH1200 and LAQUA-PH1300 only.

*2: When 0 is inputted, auto power OFF is OFF.

*3: When 0 is inputted, auto data memory is OFF.

*4: When 0 is inputted, calibration alarm interval is OFF.

■ Technical note

● pH standard solution values at various temperatures

< USA >

Temp. (°C)	pH 2 Oxalate	pH 4 Phthalate	pH 7 Neutral phosphate	pH 10 Carbonate	pH 12 Saturated calcium hydroxide solution
0	1.666	4.003	7.119	10.318	13.423
5	1.668	3.999	7.086	10.245	13.207
10	1.670	3.998	7.058	10.178	13.003
15	1.672	3.999	7.035	10.117	12.810
20	1.675	4.002	7.015	10.061	12.627
25	1.679	4.008	7.000	10.011	12.454
30	1.683	4.015	6.988	9.965	12.289
35	1.688	4.024	6.979	9.925	12.133
40	1.694	4.035	6.973	9.888	11.984
45	1.700	4.047	6.969	9.856	11.841

< NIST (pH 2, 4, 12 are common) >

Temp. (°C)	pH 7 Neutral phosphate	pH 9 Borate
0	6.984	9.464
5	6.951	9.395
10	6.923	9.332
15	6.900	9.276
20	6.881	9.225
25	6.865	9.180
30	6.853	9.139
35	6.844	9.102
40	6.838	9.068
45	6.834	9.038

Tip

The differences between USA and NIST standard solutions are a different pH 7 value, and the use of pH 9 standard solution instead of pH 10 standard solution in NIST.

Note

Calibration is performed using Nernst's equation with the above values.

■ Options

A wide variety of electrodes and options are available for use with the instrument. You can select the optimum electrode and options for your application and objectives.

These options can be purchased from your nearest agency. Please provide the part name and part number to the representative.

With regard to electrodes, it is important to select the optimum electrode for the sample you want to measure. For details, refer to the catalogue or our website, or contact your dealer.

	Part name	Part number	Remarks
Plain paper printer	Printer (USA, 120 V)	3014030146	Printer cable sold separately
	Printer (EU, 230 V)	3014030147	
	Printer cable	3014030148	1.5 m
	Roll paper	3014030149	20 rolls/set
	Ink ribbon	3014030150	5 pcs/set
	Serial cable	3014030151	1.5 m
	USB cable	3200373941	1 m
	Electrode stand (model FA-70A)	3200644455	

MEMO



HORIBA, Ltd.

2 Miyanohigashi, Kisshoin Minami-ku, Kyoto 601-8510 Japan
<http://www.horiba.com>

