

# LAQUA



pH	ORP	Ion	Conductivity
Resistivity	Total Dissolved Solids	Salinity	

## Benchtop Water Quality Meters LAQUA 1000 Series



[www.horiba-laqua.com](http://www.horiba-laqua.com)



# LAQUA

Benchtop Water Quality Instruments  
LAQUA 1000 Series

## Intuitive and easy to use

- Soft-touch operation panel
- Scratch-proof and chemical-resistant glass panel
- Large display – 5.5 inches
- Small footprint – 170(W) x 174(D) x 73(H) mm
- Protection cover included



## History of the HORIBA pH Meter

## 360° Maneuverability

- Light-weight electrode stand can be integrated with meter or placed separately
- Base of electrode stand can be used as a convenient platform for placing beakers
- Height-adjust stopper controls vertical slide of electrode stand arm

\*Taller electrode stand (650 mm) with telescopic shaft is also available



**1950**

HORIBA introduces Japan's first glass electrode pH meter.



**1964**

M-5 (benchtop) From a vacuum tube to a semiconductor, allowing miniaturization and fast response.

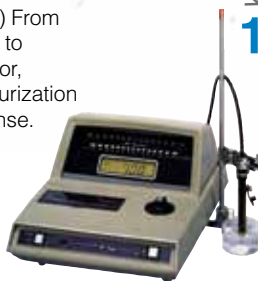

**1977**

Model F-7AD (benchtop) Incorporating an industry-first LCD display, the combination of a glass electrode, a reference electrode and a temperature-compensating electrode, makes testing easier.



Model F-80 (benchtop) The world's first instrument capable of measuring pH at 1/1000 resolution, includes an integral computer, with automatic calibration and a self-diagnostic function.



**1980**



L-7 (integrated) Introduction of a small, hand-held pH meter with the measurement electrode integrated within the main device.

**1987**



C-1 (card) Development of the world's first flat sensor.

**1990**



B-111 (Pen type) Pen type sensor allows small samples to be tested.

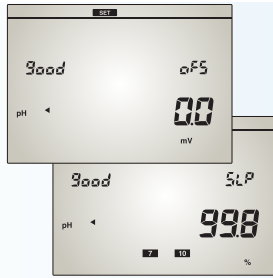

## Electrode Status

- Electrode condition is updated after each calibration and stored information can be viewed anytime
- Alert when electrode deteriorates with usage
- Programmable calibration reminders\*



## Stability function aids documentation

- Fuzzy logic determines when measured value is stable and freezes the reading on the LCD display

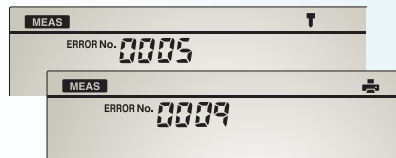

## Diagnostic messages

- Meter performs diagnosis at various stages and reports errors
- Up to 10 error codes facilitate troubleshooting-specific issues



## Data management

- Internal memory with indexed data
- Automatically log measured values to memory with Auto Log function
- Sample ID for easier sample referencing
- Date / time stamping with real-time clock\*
- Output to printer, PC or USB memory-stick\*
- RS232C or USB\* for data output

## GLP / GMP

- Important information such as model number, serial number, calibration data, electrode condition and parameters can be printed out\*
- Date / time stamping of calibration performed
- Number of calibration points done and value of calibration solutions recorded
- Electrode parameters are captured and printed\*



## Universal Power Adapter

- Multi-voltage (100-240V)
- 6 types of international standard plugs included (US, UK, EU, ANZ, Korea and China)

\*For selected models

# LAQUA

1993

2003

2011

2012

2013



F-20 (benchtop) The world's first wireless pH meter. Large graphical display gives user instructions on screen.



F-50 (desktop) World's first color LCD display. Navigation panel guides operators in how to use the meter as well as resolving errors.



D-50 (portable) Waterproof IP67-rated housing and multi parameter.



LAQUA Benchtop Water Quality Instruments



LAQUA Atwin Pocket Ion Meters



LAQUA Handheld Water Quality Instruments



Sophisticated  
Simplicity

Rugged  
Reliability

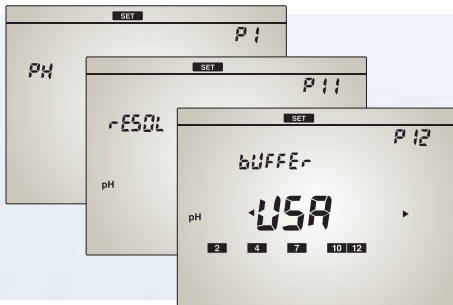

- Fuss-free advanced meter options such as Buffer Selection, Switchable Resolutions, Auto-Stable/Auto-Hold Measurement, Unit Selections, etc.

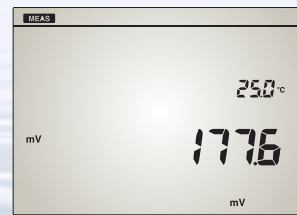

- pH or ORP measurements in all pH meters

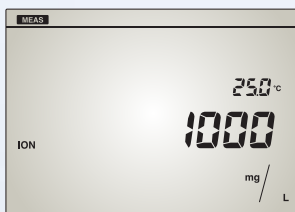

- Ion measurements in pH 1300 with respective Ion Selective Electrode

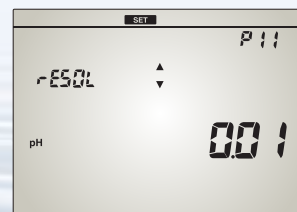

- Switchable pH Resolutions — 0.1, 0.01, 0.001

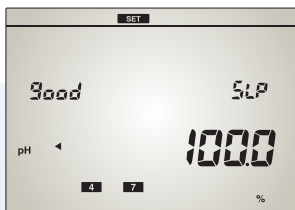

- Separate acid and alkaline slope calculation

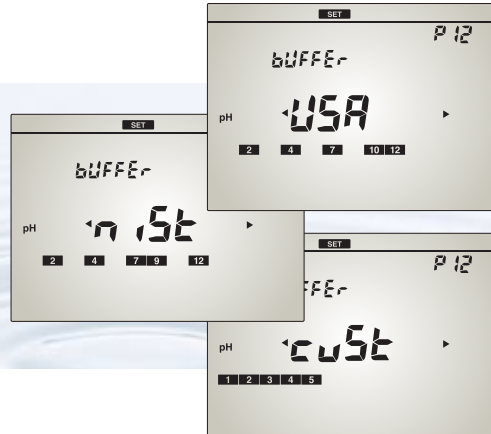
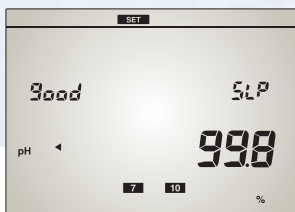

- USA, NIST or Custom buffer options
- Up to 5-point calibration

## pH Meters



Model	PH 1100	PH 1200	PH 1300
	pH/ORP/Temp (°C)	pH/ORP/Temp (°C)	pH/ORP/Ion/Temp (°C)
Part Number	3200647407	3200647408	3200647409
pH range	-2.00 to 20.00 pH	-2.000 to 20.000 pH	-2.000 to 20.000 pH
Resolution	0.1 / 0.01 pH	0.1 / 0.01 / 0.001 pH	0.1 / 0.01 / 0.001 pH
Accuracy	±0.01 pH	±0.003 pH	±0.003 pH
Cal points	5	5	5
Buffer options	USA, NIST	USA, NIST, Custom	USA, NIST, Custom
ORP range	±2000 mV	±2000 mV	±2000 mV
Resolution	0.1 mV	0.1 mV	0.1 mV
Accuracy	±0.2 mV	±0.2 mV	±0.2 mV
Ion range	--	--	0.00 µg/l to 9999 g/l
Resolution	--	--	3 significant digits
Accuracy	--	--	±0.8% full scale
Cal points	--	--	Up to 5
Temperature range	-30.0 °C to 130 °C	-30.0 °C to 130 °C	-30.0 °C to 130 °C
Resolution	0.1 °C	0.1 °C	0.1 °C
Accuracy	±0.4 °C	±0.4 °C	±0.4 °C
Cal option	Yes (±5.0 °C range in 0.1 °C increments)	Yes (±5.0 °C range in 0.1 °C increments)	Yes (±5.0 °C range in 0.1 °C increments)
Memory	500	999	999
Auto Data-logging	--	Yes	Yes
Real time clock	--	Yes	Yes
Date/time stamping	--	Yes	Yes
Auto Shut-off	--	Yes (programmable: 1 to 30 mins)	Yes (programmable: 1 to 30 mins)
Auto-Hold	Yes	Yes	Yes
Averaging/Stability	Yes, Automatic	Yes, Automatic	Yes, Automatic
Offset display	Yes	Yes	Yes
Slope display	Yes (independent acid and alkaline slopes depending on calibration)	Yes (independent acid and alkaline slopes depending on calibration)	Yes (independent acid and alkaline slopes depending on calibration)
Cal Alarm	--	Yes (programmable: 1 to 400 days)	Yes (programmable: 1 to 400 days)
Electrode status	On screen display	On screen display	On screen display
Diagnostic messages	Yes	Yes	Yes
Display	Custom LCD	Custom LCD	Custom LCD
Inputs	BNC, phono, DC sockets	BNC, phono, DC sockets	BNC, phono, DC sockets
Outputs	RS232C	USB, RS232C	USB, RS232C
Power requirements	AC adaptor 100 ~ 240 V, 50/60 Hz	AC adaptor 100 ~ 240 V, 50/60 Hz	AC adaptor 100 ~ 240 V, 50/60 Hz
Electrode stand	Integrated	Integrated	Integrated
Weight	500g	500g	500g
Dimensions	170 (L) x 174 (D) x 73 (H) mm	170 (L) x 174 (D) x 73 (H) mm	170 (L) x 174 (D) x 73 (H) mm

### Ordering information:

Kit*	PH1100-S (3999960176)	PH1200-S (3999960177)	PH1300-S (3999960178)
	<ul style="list-style-type: none"> <li>PH1100 meter</li> <li>electrode stand</li> <li>power adaptor</li> <li>pH 4.01, 7.01, 10.01, 3.33M KCl solutions</li> <li>9615S-10D - refillable, glass-body pH electrode with integrated temperature sensor, 1m cable, BNC &amp; phono jack</li> </ul>	<ul style="list-style-type: none"> <li>PH1200 meter</li> <li>electrode stand</li> <li>power adaptor</li> <li>pH 4.01, 7.01, 10.01, 3.33M KCl solutions</li> <li>9615S-10D - refillable, glass-body pH electrode with integrated temperature sensor, 1m cable, BNC &amp; phono jack</li> </ul>	<ul style="list-style-type: none"> <li>PH1300 meter</li> <li>electrode stand</li> <li>power adaptor</li> <li>pH 4.01, 7.01, 10.01, 3.33M KCl solutions</li> <li>9615S-10D - refillable, glass-body pH electrode with integrated temperature sensor, 1m cable, BNC &amp; phono jack</li> </ul>
Meter with electrode stand	<b>PH1100</b> (3200647407) <ul style="list-style-type: none"> <li>PH1100 meter</li> <li>electrode stand</li> <li>power adaptor</li> <li>protection cover</li> </ul>	<b>PH1200</b> (3200647408) <ul style="list-style-type: none"> <li>PH1200 meter</li> <li>electrode stand</li> <li>power adaptor</li> <li>protection cover</li> </ul>	<b>PH1300</b> (3200647409) <ul style="list-style-type: none"> <li>PH1300 meter</li> <li>electrode stand</li> <li>power adaptor</li> <li>protection cover</li> </ul>
pH Electrode	<b>9615S-10D</b> (3200585428) <ul style="list-style-type: none"> <li>refillable, glass-body pH electrode with integrated temperature sensor, 1m cable, BNC &amp; phono jack</li> </ul>	<b>9615S-10D</b> (3200585428) <ul style="list-style-type: none"> <li>refillable, glass-body pH electrode with integrated temperature sensor, 1m cable, BNC &amp; phono jack</li> </ul>	<b>9615S-10D</b> (3200585428) <ul style="list-style-type: none"> <li>refillable glass-body pH electrode with integrated temperature sensor, 1m cable, BNC &amp; phono jack</li> </ul>
USA pH buffer set	<b>101-SU</b> (3200738717) <p>pH 4.01, 7.01, 10.01, 3.33M KCl solutions</p>	<b>101-SU</b> (3200738717) <p>pH 4.01, 7.01, 10.01, 3.33M KCl solutions</p>	<b>101-SU</b> (3200738717) <p>pH 4.01, 7.01, 10.01, 3.33M KCl solutions</p>
NIST pH buffer set	<b>101-S</b> (3200043642) <p>pH 4.01, 6.86, 9.18, 3.33M KCl solutions</p>	<b>101-S</b> (3200043642) <p>pH 4.01, 6.86, 9.18, 3.33M KCl solutions</p>	<b>101-S</b> (3200043642) <p>pH 4.01, 6.86, 9.18, 3.33M KCl solutions</p>

\*Kit with 501-S is available upon request. Add 'N' suffix to the order code when ordering.

# LAQUA

Benchtop Water Quality Instruments  
LAQUA 1000 Series

- Wide measurement range
- EC/TDS/Res/Sal in one meter
- Auto-calibration
- Multi-calibration points
- Preset TDS calibration curves
- Preset Salinity calibration curves
- Rugged conductivity cell construction

## TDS Calibration Curves

Application	Key chemical species	TDS selection
Aquaculture, pickling	NaCl	NaCl
Boiler water, HVAC	Na <sub>2</sub> SO <sub>4</sub> , NaHCO <sub>3</sub> , NaCl	442 (Myron)
Environmental	EN standard for environmental water	EN 27888
General application	Not known	KCl (linear factor) Default: 0.5 Selectable: 0.4 to 1.0

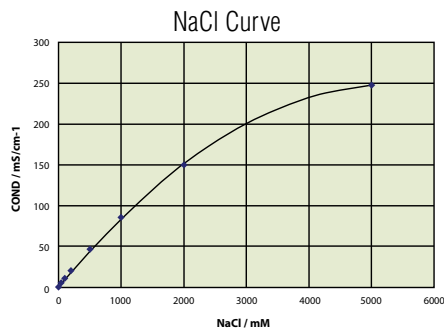
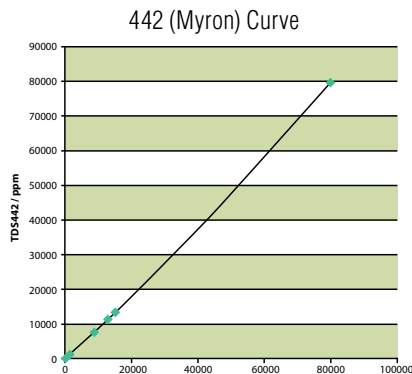
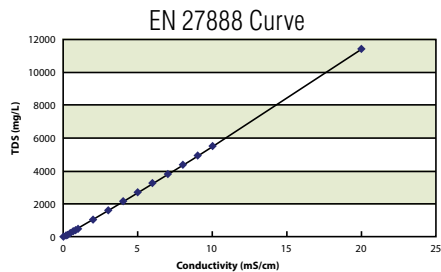

## Conductivity Meter



Model		EC 1100
EC range		EC/TDS/Res/Sal/Temp (°C) .. μS/cm to 19.99 μS/cm .. μS/cm to 1999.0 μS/cm .. μS/cm to 20.00 mS/cm .. μS/cm to 200.0 mS/cm .. μS/cm to 2000.0 mS/cm
Resolution		0.05% F.S.
Accuracy		±0.6% F.S. (±1.5% F.S. > 18.0 mS/cm)
Ref. temp.		15 to 30 °C (selectable)
Temp. coefficient		0.0 to 10.0% (selectable)
Cell constants		0.1 / 1.0 / 10.0
Cal points		4 points (Auto/Manual)
Units setting		Auto ranging / Manual μS/cm or mS/cm or S/m
TDS range		0.01 ppm to 9.99 ppm 0.1 ppm to 999.9 ppm 1 ppm to 10.00 ppt 10 ppm to 100.0 ppt 100.0 ppm to 1000.0 ppt
Resolution		0.01ppm / 0.1 ppt
Accuracy		±0.1% F.S.
TDS curves		EN27888, 442, linear (0.40 to 1.0), NaCl
Resistivity Range		0.000 Ω/cm to 20.000 Ω/cm 0.00 Ω/cm to 200.0 MΩ/cm
Resolution		0.05% F.S.
Accuracy		0.6% F.S. (±1.5% F.S. > 1.80 MΩ/cm)
Salinity		0.0 to 100.0 ppt 0.00 to 10.00 %
Resolution		0.1 ppt / 0.01%
Accuracy		0.2% F.S.
Cal curves		NaCl / Sea water
Temperature range		-30.0 °C to 130 °C
Resolution		0.1 °C
Accuracy		±0.4 °C
Memory		500
Auto-Hold		Yes
Diagnostic messages		Yes
Display		Custom LCD
Inputs		BNC, phono, DC sockets
Outputs		USB, RS232C
Power requirements		AC adaptor 100 ~ 240 V, 50/60 Hz
Electrode stand		Integrated
Weight		500g
Dimensions		170 (L) x 174 (D) x 73 (H) mm

## Ordering information:

Kit	<ul style="list-style-type: none"> <li>• EC1100 meter</li> <li>• electrode stand</li> <li>• power adaptor</li> <li>• 84uS/cm, 1413 uS/cm, 12.88 mS/cm, 111.8 mS/cm solutions</li> <li>• 9382-10D - plastic-body, k=1.0 conductivity cell with integrated temperature sensor, 1m cable, BNC &amp; phono jack</li> </ul> <p><b>EC1100-S</b> (3999960179)</p>
Meter with electrode stand	<ul style="list-style-type: none"> <li>• EC1100 meter</li> <li>• electrode stand</li> <li>• power adaptor</li> <li>• protection cover</li> </ul> <p><b>EC1100</b> (3200647411)</p>
Conductivity cell	<ul style="list-style-type: none"> <li>• plastic-body, k=1.0 conductivity cell with integrated temperature sensor, 1m cable, BNC &amp; phono jack</li> </ul> <p><b>9382-10D</b> (3014046709)</p>
Conductivity standard solutions set	<ul style="list-style-type: none"> <li>• 84uS/cm, 1413 uS/cm, 12.88 mS/cm, 111.8 mS/cm solutions</li> </ul> <p><b>103-S</b> (3200738718)</p>

## Multi-Parameter Meter



**PC 1100**

Model	<b>PC 1100</b>
Dual Channel pH/ORP/ EC/TDS/Res/Sal/Temp (°C)	
pH range	-2.000 to 20.000 pH
Resolution	0.1 / 0.01 / 0.01 pH
Accuracy	±0.003 pH
Cal points	5
Buffer options	USA, NIST, Custom

ORP range	±2000 mV
Resolution	0.1 mV
Accuracy	±0.2 mV

EC range	<ul style="list-style-type: none"> <li>.. µS/cm to 19.99 µS/cm</li> <li>.. µS/cm to 1999.0 µS/cm</li> <li>.. µS/cm to 20.00 mS/cm</li> <li>.. µS/cm to 200.0 mS/cm</li> <li>.. µS/cm to 2000.0 mS/cm</li> </ul>
Resolution	0.05% F.S.
Accuracy	±0.6% F.S. (±1.5% F.S. > 18.0 ms/cm)
Ref. temp.	15 to 30 °C (selectable)
Temp. coefficient	0.0 to 10.0% (selectable)
Cell constants	0.1 / 1.0 / 10.0
Cal points	4 points (Auto/Manual)
Units setting	Auto ranging / Manual µS/cm or mS/cm or S/m

TDS range	<ul style="list-style-type: none"> <li>0.01 ppm to 9.99 ppm</li> <li>0.1 ppm to 999.9 ppm</li> <li>1 ppm to 10.00 ppt</li> <li>10 ppm to 100.0 ppt</li> <li>100.0 ppm to 1000.0 ppt</li> </ul>
Resolution	0.01ppm / 0.1 ppt
Accuracy	±0.1% F.S.
TDS curves	EN27888, 442, linear (0.40 to 1.0), NaCl

Resistivity Range	0.000 Ω/cm to 20.000 Ω/cm 0.00 Ω/cm to 200.0 MΩ/cm
Resolution	0.05% F.S.
Accuracy	0.6% F.S. (±1.5% F.S. > 1.80 MΩ/cm)

Salinity	0.0 to 100.0 ppt 0.00 to 10.00 %
Resolution	0.1 ppt / 0.01%
Accuracy	0.2% F.S.
Cal curves	NaCl / Sea water

Temperature range	-30.0 °C to 130 °C
Resolution	0.1 °C
Accuracy	±0.4 °C

- pH/ORP/EC/TDS/Res/Sal/Temp (°C) in one meter
- Combination of PH 1200 & EC 1100
- Simultaneous measurement on 2 channels



- Dual channel, dual display

Memory	999
Auto Data-logging	Yes
Real time clock	Yes
Date/time stamping	Yes
Auto Shut-off	Yes (programmable: 1 to 30 mins)
Auto-Hold	Yes
Averaging/Stability	Yes, Automatic
Offset display	Yes
Slope display	Yes (independent acid and alkaline slopes depending on calibration)
Cal Alarm	Yes (programmable: 1 to 400 days)
Electrode status	On screen display
Diagnostic messages	Yes
Display	Custom LCD, Dual channel display
Inputs	Dual BNC, dual phono, DC sockets
Outputs	USB, RS232C
Power requirements	AC adaptor 100 ~ 240 V, 50/60 Hz
Electrode stand	Integrated
Weight	500g
Dimensions	170 (L) x 174 (D) x 73 (H) mm

### Ordering information:

Kit*	<b>PC1100-S</b> (3999960180)	<ul style="list-style-type: none"> <li>• PC1100 meter</li> <li>• electrode stand</li> <li>• power adaptor</li> <li>• 9615S-10D - refillable, glass-body pH electrode with integrated temperature sensor, 1m cable, BNC &amp; phono jack</li> <li>• 9382-10D - plastic-body, k=1.0 conductivity cell with integrated temperature sensor, 1m cable, BNC &amp; phono jack</li> <li>• pH 4.01, 7.01, 10.01, 3.33M KCl solutions (250ml ea)</li> <li>• 84µS/cm, 1413 µS/cm, 12.88 mS/cm, 111.8 mS/cm solutions (250ml ea)</li> </ul>
	<b>PC1100</b> (3200647410)	<ul style="list-style-type: none"> <li>• PC1100 meter</li> <li>• electrode stand</li> <li>• power adaptor</li> <li>• protection cover</li> </ul>
pH Electrode	<b>9615S-10D</b> (3200585428)	<ul style="list-style-type: none"> <li>• refillable, glass-body pH electrode with integrated temperature sensor, 1m cable, BNC &amp; phono jack</li> </ul>
Conductivity cell	<b>9382-10D</b> (3014046709)	<ul style="list-style-type: none"> <li>• plastic-body, k=1.0 conductivity cell with integrated temperature sensor, 1m cable, BNC &amp; phono jack</li> </ul>
USA pH buffer set	<b>101-SU</b> (3200738717)	<ul style="list-style-type: none"> <li>• pH 4.01, 7.01, 10.01, 3.33M KCl solutions</li> </ul>
NIST pH buffer set	<b>101-S</b> (3200043642)	<ul style="list-style-type: none"> <li>• pH 4.01, 6.86, 9.18, 3.33M KCl solutions</li> </ul>
Conductivity standard solutions set	<b>103-S</b> (3200738718)	<ul style="list-style-type: none"> <li>• 84µS/cm, 1413 µS/cm, 12.88 mS/cm, 111.8 mS/cm solutions</li> </ul>

\*Kit with 101-S (NIST pH buffer set) is available upon request. Add 'N' suffix to the order code when ordering.

# pH Electrode Selection Guide

		3-in-1 ELECTRODES												COMBINATION ELECTRODES			
		PLASTIC					STANDARD ToupH	LONG ToupH	MICRO ToupH	SLEEVE ToupH	SLEEVE	NON-AQUEOUS	NEEDLE	PLASTIC	STANDARD ToupH	MICRO ToupH	SLEEVE ToupH
		9625-10D	9630-10D	9631-10D	9632-10D	9651-10D	9615S-10D	9680S-10D	9618S-10D	9681S-10D	6367-10D	6377-10D	6252-10D	9425-10C	9415-10C	9418-10C	9481-10C
Specification	Applicable temperature range (°C)	0-100	0-100	0-60	0-100	0-60	0-100	0-100	0-60	0-60	0-60	0-60	0-60	0-100	0-100	0-60	0-60
	Diameter (mm)	16	16	16	16	16	12	8	3	12	12	12	12	16	12	3	12
	Length (mm)	150	150	155	150	150	198	283	185	203	150	150	150	150	198	185	203

## pH - Sample Conditions

Aqueous Solution	Conductivity	Normal (over 100 mS/m)	●	●	●	●	●	●	●	●	●	●	●	●	●	●	●	
		Low (approx. 10 ~100 mS/m)		●							○		●					○
		Very low (approx. 5 ~100 mS/m)		○							○		●					○
		High (approx. 5 S/m)	○	○	○	○	○	○	○		●				○	○		●
	Strong alkaline (pH 10-12)				●		○	○		○	○				○		○	
	Strong acidity (pH 0-2) * Except HF sample			●			●								●			
	Quick heat change (within 50°C)	●	●	●	●	●								●				
	High viscosity (approx. 5 Pa·S)									●	○	●					●	
	Containing non-aqueous solvent						○	○	○	○	○	●			○	○	○	
Suspension						○	○	○	●		●			○	○	●		
Solid/ Semisolid	Inside												○					
	Surface																	

Sample Containers	Microtube/plate (> 50 µL)								●							●	
	Ampule > ø4 mm								●							●	
	Micro container (> 2 mL)							○	●							●	
	Tube ID: 13 mm, L: 100 ~ 150 mm								●								
	Beaker 10 mL ~ 1 L	●	●	●	●	●	●	○	○	○	○	○	○	●	●	○	○
	Large container (> 1 L)	○	○	○	○	○	○	○	●					○	○		
	Petri dish																
	Droplet																

Water	Pure/ion-exchange water (approx. 0.1 mS/m)/ Distilled water (approx. 0.5 mS/m)						○					●			○		
	Tap/drinking water (approx. 10 mS/m)	○	●			○	○			○		●		○	○		○
	Surface water		●				○			○		●		○	○		○
	Pharmaceutical water/ Environmental water/acid rain	○	○			○	○			○		○		○	○		○
Chemical reagent/ solvent	Caustic/strong acid (Except HF sample)			●			●			○				●			○
	Hydrofluoric acid			●													
	Surfactant						○			●		○		○			●
	Water-based paint						○			●		○		○			●
Pharmaceutical/ biological sample	Dye/coloring agent						○			●		○		○			●
	Protein-containing sample						○		○	●	○			○	○		●
	Medicinal preparation								○	○		○			○		○
	Enzyme solution							○	●				○		●		
	Tris buffer						●		○	○				●	○		○
Food	Suspension						○		○	●		●		○			●
	Agar medium									○				○			○
	Jam						○			●		○	○		○		●
	Meat/fish/Fruit/vegetable/ Dough												●				
	Honey												●				
Beverage/ seasoning	Cheese/butter												○				
	Yogurt	○	○			○	○			○	○	○	○	○	○		○
	Beer	○	○			○	○			●	○	●		○	○		●
	Milk/Carbonated drink/juice/ sauce/soy sauce						○			●	○	○			○		●
Cosmetic/ lotion	Mayonnaise/ketchup						○			●		○		○			●
	Beauty cream/mascara						○			●		○	○	○			●
	Gel/soap/shampoo/Hair dye lotion						○			●		○		○			●
Emulsified liquid						○			○		●		○	○		○	









## Combination ISE

Ion-selective electrodes are responsive to concentration of particular ions in the test liquid and are variable-potential electrodes. They are used in conjunction with reference electrodes to measure the concentration of particular ions. HORIBA's years of experience and know-how in this field are behind the wide range of ion electrodes we offer.

When measurements are made using an ion meter, calibrating it with various standard solutions will give direct readings of the ion concentration. Note that since volume-detection level changes with temperature, measurements must be taken at a fixed temperature.

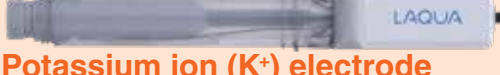
Model	Accessories Included	Temp. Range (°C)	Measurement Range	pH Range
 <p><b>Ammonia ion (NH<sub>3</sub>) electrode</b>  <b>5002S-10C</b>            3200698386            Overall length: 161 mm            Diameter of probe: 15 mm            Connector: BNC</p>	<ul style="list-style-type: none"> <li>• membrane cap, 3pcs</li> <li>• 1000mg/L ammonium ion standard solution, 50ml</li> <li>• 100mg/L ammonium ion standard solution, 50ml</li> <li>• ammonia electrode filling solution, 50ml</li> <li>• syringe</li> <li>• dropper</li> <li>• protective pipe</li> <li>• manual</li> </ul>	0 - 50	0.1 - 1,000 mg/L NH <sub>3</sub>	Adjust more than pH 12
 <p><b>Calcium ion (Ca<sup>2+</sup>) electrode</b>  <b>6583S-10C</b>            3200697410            Overall length: 150 mm            Diameter of probe: 16 mm            Connector: BNC</p>	<ul style="list-style-type: none"> <li>• calcium electrode tip, 2pcs</li> <li>• 1000mg/L calcium ion standard solution, 50ml</li> <li>• 100mg/L calcium ion standard solution, 50ml</li> <li>• calcium electrode filling solution, 50ml</li> <li>• calcium ionic strength adjustor, 50ml</li> <li>• syringe</li> <li>• dropper</li> <li>• protective pipe</li> <li>• manual</li> </ul>	0 - 50	0.4 - 40,080 mg/L Ca <sup>2+</sup> (10 <sup>-5</sup> to 1 mol/L Ca <sup>2+</sup> )	4.0 mg/L (10 <sup>-4</sup> mol/L) Ca <sup>2+</sup> , pH 5 to 11
 <p><b>Chloride ion (Cl<sup>-</sup>) electrode</b>  <b>6560S-10C</b>            3200697407            Overall length: 150 mm            Diameter of probe: 16 mm            Connector: BNC</p>	<ul style="list-style-type: none"> <li>• chloride electrode tip</li> <li>• 1000mg/L chloride ion standard solution, 50ml</li> <li>• 100mg/L chloride ion standard solution, 50ml</li> <li>• chloride electrode filling solution, 50ml</li> <li>• chloride ionic strength adjustor, 50ml</li> <li>• syringe</li> <li>• dropper</li> <li>• protective pipe</li> <li>• water-resistant abrasive sheet</li> <li>• manual</li> </ul>	0 - 50	0.35 - 35,000 mg/L Cl <sup>-</sup> (10 <sup>-5</sup> to 1 mol/L Cl <sup>-</sup> )	350 mg/L (10 <sup>-2</sup> mol/L) Cl <sup>-</sup> , pH 3 to 11
 <p><b>Fluoride ion (F<sup>-</sup>) electrode</b>  <b>6561S-10C</b>            3200693774            Overall length: 150 mm            Diameter of probe: 16 mm            Connector: BNC</p>	<ul style="list-style-type: none"> <li>• fluoride electrode tip</li> <li>• 1000mg/L fluoride ion standard solution, 50ml</li> <li>• 100mg/L fluoride ion standard solution, 50ml</li> <li>• fluoride electrode filling solution, 50ml</li> <li>• fluoride ionic strength adjustor, 50ml</li> <li>• syringe</li> <li>• dropper</li> <li>• protective pipe</li> <li>• manual</li> </ul>	0 - 50	0.2 - 19,000 mg/L F <sup>-</sup> (10 <sup>-6</sup> to 1 mol/L F <sup>-</sup> )	20 mg/L (10 <sup>-3</sup> mol/L) F <sup>-</sup> , pH 4 to 10
 <p><b>Nitrate ion (NO<sub>3</sub><sup>-</sup>) electrode</b>  <b>6581S-10C</b>            3200697408            Overall length: 150 mm            Diameter of probe: 16 mm            Connector: BNC</p>	<ul style="list-style-type: none"> <li>• nitrate electrode tip, 2pcs</li> <li>• 1000mg/L nitrate ion standard solution, 50ml</li> <li>• 100mg/L nitrate ion standard solution, 50ml</li> <li>• nitrate electrode filling solution, 50ml</li> <li>• nitrate ionic strength adjustor, 50ml</li> <li>• syringe</li> <li>• dropper</li> <li>• protective pipe</li> <li>• manual</li> </ul>	0 - 50	0.62 - 62,000 mg/L NO <sub>3</sub> <sup>-</sup> (10 <sup>-5</sup> to 1 mol/L NO <sub>3</sub> <sup>-</sup> )	62 mg/L (10 <sup>-3</sup> mol/L) NO <sub>3</sub> <sup>-</sup> , pH 3 to 7
 <p><b>Potassium ion (K<sup>+</sup>) electrode</b>  <b>6582S-10C</b>            3200697409            Overall length: 150 mm            Diameter of probe: 16 mm            Connector: BNC</p>	<ul style="list-style-type: none"> <li>• potassium electrode tip, 2pcs</li> <li>• 1000mg/L potassium ion standard solution, 50ml</li> <li>• 100mg/L potassium ion standard solution, 50ml</li> <li>• potassium electrode filling solution, 50ml</li> <li>• potassium ionic strength adjustor, 50ml</li> <li>• syringe</li> <li>• dropper</li> <li>• protective pipe</li> <li>• manual</li> </ul>	0 - 50	0.04 - 39,000 mg/L K <sup>+</sup> (10 <sup>-6</sup> to 1 mol/L K <sup>+</sup> )	3.9 mg/L (10 <sup>-4</sup> mol/L) K <sup>+</sup> , pH 5 to 11

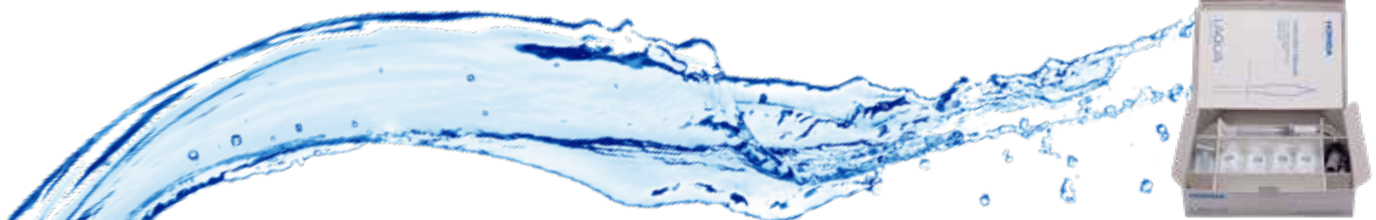





Selection Coefficient	Replacement Tip	Electrode Filling Solution	100mg/L Standard Solution	1000mg/L Standard Solution	Ionic Strength Adjustor	Applications
—	 <p><b>NH<sub>3</sub> electrode membrane caps</b> 3200705774</p>	500-NH3-IFS 3200697173	500-NH4-SL 3200697172	500-NH4-SH 3200697171	500-NH3-ISA 3200697174 	Agriculture, Soil, Power Station Water, Fish Tanks, Sea Water, Waste Water, Plating Baths, Air / Stack Gases and Biological Cultures or Samples
$Fe^{3+} = 0.1, Fe^{2+}, Zn^{2+} = 1, Sr^{2+} = 50$ $Ni^{2+}, Cu^{2+} = 70, Co^{2+} = 350$ $Mn^{2+} = 500, Mg^{2+} = 1,000$ $Na^+, K^+, Ba^{2+}, NH_4^+ = \text{over } 1,000$	 <p><b>7683S</b> 3200697414</p> <p><b>Calcium</b></p>	500-CA-IFS 3200697177	500-CA-SL 3200697176	500-CA-SH 3200697175	500-CA-ISA 3200697178	Agriculture / Plant Tissue, Soil, Water Softening Systems, Boiler Feed Water, Drinking / Mineral Water, Biological Cultures, Dental / Clinical Analysis and Dairy / Food / Beverages Applications
$S_2O_3^{2-}, S^{2-}, I^-, Ag^+, Hg^{2+} = \text{Not acceptable}$ $SCN^- = 0.3, MnO_4^- = 0.1$ $Br^- = 0.03$ $NO_3^-, F^-, HCO_3^-, SO_4^{2-}, PO_4^{2-} = 1,000$	 <p><b>7660S</b> 3200697411</p> <p><b>Chloride</b></p>	500-CL-IFS 3200697169	500-CL-SL 3200697168	500-CL-SH 3200697167	500-CL-ISA 3200697170	Agriculture, River / Tap Water, Plant Tissue, Soils, Boiler Feed Water, Clinical Analysis, Sweat, Urine, Cement, Plating Baths and Dairy / Food / Beverages Samples
Possible interference when multiply-charged ion (ex. $Al^{3+}, Fe^{3+}$ ) coexisted and foamed the complex.	 <p><b>7661S</b> 3200693606</p> <p><b>Fluoride</b></p>	500-F-IFS 3200697165	500-F-SL 3200697164	500-F-SH 3200697163	500-F-TISAB 3200697166	Dental / Toothpaste / Mouth Wash, Drinking / Seawater, Wastewater, Air / Stack Gases, Acids, Soils, Food, Biological Fluids, Plant Tissue, Coal, Carbonated Beverages and Bone
$ClO_4^-, I^- = \text{Not acceptable}, Br^- = 2$ $NO_2^- = 3, Cl^- = 300$ $HCO_3^-, H_2PO_4^-, SO_4^{2-} = \text{over } 1000$	 <p><b>7681S</b> 3200697412</p> <p><b>Nitrate</b></p>	500-NO3-IFS 3200697181	500-NO3-SL 3200697180	500-NO3-SH 3200697179	500-NO3-ISA 3200697182	Agriculture / Plant Tissue / Fertilizers, Surface / Seawater / Drinking Water, Sewage Effluent, Soils, Meats, Vegetables, Foods / Beverages
$Rb^+ = 0.4, Cs^+ = 3, NH_4^+ = 70$ $Li^+, Na^+, Mg^{2+}, Ca^{2+}, Sr^{2+}, Ba^{2+} = \text{over } 1,000$	 <p><b>7682S</b> 3200697413</p> <p><b>Potassium</b></p>	500-K-IFS 3200697185	500-K-SL 3200697184	500-K-SH 3200697183	500-K-ISA 3200697186	Agriculture / Plant Tissue, Soils, Wastewater, River / Tap Water, Clinical Analysis, Saliva, Serum, Fertilizers, Soils and Wines, Dairy / Foods / Beverages

Note: Detailed information on standard solutions, ISAs, and filling solutions can be found on page 21





## Metallic Electrode (For ORP Measurement)

Model	Operating Temperature Range (°C)	Electrode Material	Internal Solution	Applications
<b>ORP Electrode</b> <b>9300-10D</b> Waterproof platinum 3-in-1 type  Overall length: 150 mm Diameter of probe: 12 mm Connectors: BNC & phono jack 3014046710	0-60	Pt / Glass	#300 (KCl)	Waterproof; Platinum on the flat tip allows measurement of small volume samples

## Conductivity Cells (Submersible Type)

Model	Cell Constant	Measurement Range	Temp. Range (°C)	Cell Material	Thermistor	Minimum Sample Volume (ml)	Application
<b>3551-10D</b>  Overall length: 175 mm Diameter of probe: 23 mm Connectors: BNC & phono jack 3014081712	0.1 cm <sup>-1</sup>	0.1 μS/cm - 10 mS/cm	0 - 60	Pt-Pt black / Glass	Built-in	50	Low conductivity water (e.g., deionized, distilled)
	10 m <sup>-1</sup>	10 μS/m - 1 S/m					
<b>3552-10D</b>  Overall length: 150 mm Diameter of probe: 12 mm Connectors: BNC & phono jack 3014081545	1 cm <sup>-1</sup>	1 μS/cm - 100 mS/cm	0 - 100	Pt-Pt black / Glass	Built-in	15	General purpose use
	100 m <sup>-1</sup>	0.1 mS/m - 10 S/m					
<b>3553-10D</b>  Overall length: 175 mm Width of probe: 28 mm Connectors: BNC & phono jack 3014081714	10 cm <sup>-1</sup>	10 μS/cm - 1 S/cm	0 - 60	Pt-Pt black / Glass	Built-in	50	High conductivity water
	1000 m <sup>-1</sup>	1 mS/m - 100 S/m					
<b>9382-10D</b>  Overall length: 150 mm Diameter of probe: 16 mm Connectors: BNC & phono jack 3014046709	1 cm <sup>-1</sup>	1 μS/cm - 100 mS/cm	0 - 80	Ti-Pt black / Plastic	Built-in	20-30	General purpose use; Waterproof
	100 m <sup>-1</sup>	0.1 mS/m - 10 S/m					

## Conductivity Cells (Flow Type)

Model	Cell Constant	Measurement Range	Temp. Range (°C)	Cell Material	Thermistor	Minimum Sample Volume (ml)	Application
<b>3561-10D</b>  Overall length: 143 mm Diameter of probe: 18 mm Connectors: BNC & phono jack 3014082350	0.1 cm <sup>-1</sup>	0.1 μS/cm - 10 mS/cm	0 - 60	Pt-Pt black / Glass	Built-in	10	Low conductivity water (e.g., deionized, distilled)
	10 m <sup>-1</sup>	10 μS/m - 1 S/m					
<b>3562-10D</b>  Overall length: 205 mm Diameter of probe: 18 mm Connectors: BNC & phono jack 3014082350	1 cm <sup>-1</sup>	1 μS/cm - 100 mS/cm	0 - 60	Pt-Pt black / Glass	Built-in	16	General purpose use
	100 m <sup>-1</sup>	0.1 mS/m - 10 S/m					
<b>3573-10C</b>  Overall length: 222 mm Diameter of probe: 18 mm Connector: BNC 3014082590	10 cm <sup>-1</sup>	10 μS/cm - 1 S/cm	0 - 60	Pt-Pt black / Glass	—	4	High conductivity water
	1000 m <sup>-1</sup>	1 mS/m - 100 S/m					
<b>3574-10C</b>  Overall length: 136 mm Diameter of probe: 66 mm Connector: BNC 3014082592	10 cm <sup>-1</sup>	10 μS/cm - 100 mS/cm	0 - 60	Pt-Pt black / Glass	—	0.25	Small volume sample (e.g., column chromatography)
	1000 m <sup>-1</sup>	1 mS/m - 10 S/m					



ORP Powders



220

250

300



230

Cleaning Solutions

### pH Buffer Solutions

Code	Part No.	Description	Volume
100-2	3200043639	pH 1.68 Buffer Solution at 25°C	500ml
100-4	3200043638	pH 4.01 Buffer Solution at 25°C	500ml
101-SU	3200738717	pH Buffer Set (pH 4.01, 7.00, 10.01, 3.33M KCl)	-
100-7U	3200738711	pH 7.00 Buffer Solution at 25°C	500ml
100-9	3200043636	pH 9.18 Buffer Solution at 25°C	500ml
100-10U	3200738712	pH 10.01 Buffer Solution at 25°C	500ml
12.46	-	Available on request	500ml

### Conductivity Standard Solutions

Code	Part No.	Description	Volume
100-21	3200738713	84 µS/cm Conductivity Standard Solution	500ml
100-22	3200738714	1413 µS/cm Conductivity Standard Solution	500ml
100-23	3200738715	12.88 mS/cm Conductivity Standard Solution	500ml
100-24	3200738716	111.8 mS/cm Conductivity Standard Solution	500ml
103-S	3200738718	Conductivity Standard Solution Set (84 µS/cm, 1413 µS/cm, 12.88 mS/cm, 111.8 mS/cm)	-

### ORP Powders

Code	Part No.	Description	Volume
160-51	3200043618	89 mV at 25°C (for 250ml solution)	10 sachets/ pack
160-22	3200043617	258 mV at 25°C (for 250ml solution)	10 sachets/ pack

### pH/ORP Electrode Filling Solutions

Code	Part No.	Description	Volume
300	3200043640	3.33M KCl	250ml

### pH Electrode Cleaning Solutions

Code	Part No.	Description	Volume
220	3014028653	For removing inorganic residues from glass membrane and liquid junction	2 x 50ml
230	3200530494	For removing inorganic and organic residues from glass membrane (30ml Solution A & 100ml Solution B)	30ml & 100ml
250	3200366771	For removing protein residues from glass membrane and liquid junction	400ml



Calcium Ion Electrode Solutions



Chloride Ion Electrode Solutions



Fluoride Ion Electrode Solutions



Potassium Ion Electrode Solutions



Ammonia Ion Electrode Solutions



Nitrate Ion Electrode Solutions

### Ion Standard Solutions











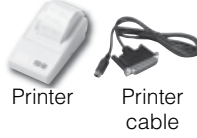





Code	Part No.	Description	Volume
500-NH4-SH	3200697171	1000 mg/L Ammonium Ion Standard Solution	500ml
500-NH4-SL	3200697172	100 mg/L Ammonium Ion Standard Solution	500ml
500-CA-SH	3200697175	1000 mg/L Calcium Ion Standard Solution	500ml
500-CA-SL	3200697176	100 mg/L Calcium Ion Standard Solution	500ml
500-CL-SH	3200697167	1000 mg/L Chloride Ion Standard Solution	500ml
500-CL-SL	3200697168	100 mg/L Chloride Ion Standard Solution	500ml
500-F-SH	3200697163	1000 mg/L Fluoride Ion Standard Solution	500ml
500-F-SL	3200697164	100 mg/L Fluoride Ion Standard Solution	500ml
500-NO3-SH	3200697179	1000 mg/L Nitrate Ion Standard Solution	500ml
500-NO3-SL	3200697180	100 mg/L Nitrate Ion Standard Solution	500ml
500-K-SH	3200697183	1000 mg/L Potassium Ion Standard Solution	500ml
500-K-SL	3200697184	100 mg/L Potassium Ion Standard Solution	500ml

### Ionic Strength Adjustors

Code	Part No.	Description	Volume
500-NH3-ISA	3200697174	Ammonia Ionic Strength Adjustor 	500ml
500-CA-ISA	3200697178	Calcium Ionic Strength Adjustor	500ml
500-CL-ISA	3200697170	Chloride Ionic Strength Adjustor	500ml
500-F-TISAB	3200697166	Fluoride Ionic Strength Adjustor	500ml
500-NO3-ISA	3200697182	Nitrate Ionic Strength Adjustor	500ml
500-K-ISA	3200697186	Potassium Ionic Strength Adjustor	500ml

### Ion Selective Electrode Filling Solutions

Code	Part No.	Description	Volume
500-NH3-IFS	3200697173	Ammonia Electrode Filling Solution	500ml
500-CA-IFS	3200697177	Calcium Electrode Filling solution	500ml
500-CL-IFS	3200697169	Chloride Electrode Filling Solution	500ml
500-F-IFS	3200697165	Fluoride Electrode Filling Solution	500ml
500-NO3-IFS	3200697181	Nitrate Electrode Filling Solution	500ml
500-K-IFS	3200697185	Potassium Electrode Filling Solution	500ml

Accessories		
Code	Part No.	Description
 LAQUA-SW-21CFR11	3200707161	21 CFR Part 11 Software includes CD with PIN code, USB cable, and manual
	5700012747	Printer (for GLP/GMP compliance) Cable sold separately, Plain paper
	3014030148	Printer cable (1.5 m)
	3014030149	Printer paper (20 rolls)
	3014030150	Ink ribbon (5 pcs/set)
 Universal AC adapter	3200647413	Multi-Voltage (100-240V) with 6 plugs, (US, UK, EU, ANZ, Korea and China) 1.8 m cable
 X-51	3014028368	Digital simulator X-51 (pH, mV, Ion, DO, temperature simulator)
 X-52	3014028370	Digital simulator X-52 (Conductivity, temperature simulator)
 LCD protection sheet	3200382462	LCD protection sheet (2 pcs/pack)
 Protection cover sheet	3200382441	Protection cover (Protects the meter for F-70, DS-70, 1000 series)
 USB cable	3200373941	USB cable (to connect meter and PC.)
 Serial cable	3014030152	Analog cable (Analog (alarm) output cable)
	3014030151	Serial cable (to connect meter and PC (Serial, 9 pins))
FA-70S	3200382557	Adjustable, free-standing electrode stand (Height: 384 mm) image on the right
FA-70L	3200382560	Long, free-standing electrode stand (Height: 450-650mm) image on the right
	3200373991	Arm for electrode stand FA-70A, FA-70S, & FA-70L
	3200373961	Electrode holders, 2pcs (for mounting electrode with round cap on electrode stand arm)
	3200382477	Electrode protection caps, 3pcs (for 9615S-10D, 9618S-10D, 9681S-10D pH electrode)
	3200043508	Electrode protection caps, 5pcs (for 9621-10D, 9625-10D, 9630-10D, 9631-10D, 9632-10D, 6367-10D, 6377-10D, 6252-10D, 6261-10C, 1066A-10C, 1076-10C, 2060-10T, 9300-10D, 9382-10D, 3552-10D pH electrode)
	3200382482	Electrode protection cap for long electrode (for 9680S-10D, 9480-10C pH Electrode)

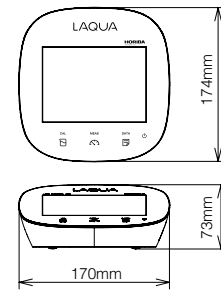

Body • Standard Electrode Stand

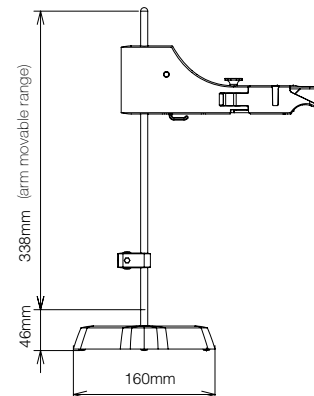

Long Type Electrode Stand

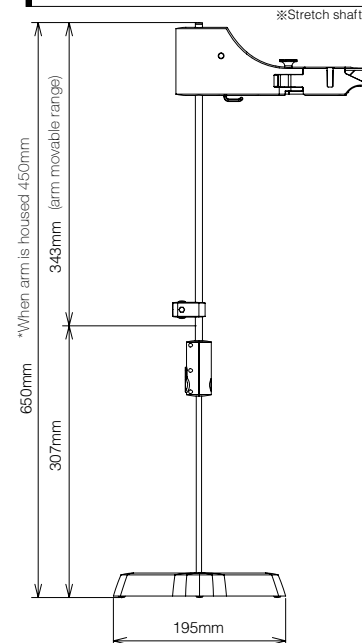

Standard Electrode Stand  
FA-70S (384mm)

Long Type Electrode Stand  
FA-70L (450-650m m)

Visit **HORIBA's website!**

[www.horiba-laqua.com](http://www.horiba-laqua.com)

## Water Quality Analyzers

With over 60 years of engineering excellence, HORIBA's diverse range of water quality analyzers and electrodes are ideal for the most demanding of applications. Visit our website for a wealth of useful information and water quality measurement tips to help you obtain the best results in your work.



### Electrodes

HORIBA's superior electrode technology has been employed in manufacturing our unparalleled tough pH glass bulbs and unique flat sensors. Our electrodes have different designs to cater a wide range of applications—from pure water to complex samples. Select the suitable electrode that is specially designed for your application.



### Handheld Meters

In the lab, in the field or anywhere you need it. LAQUA Handheld meters are designed for use with one hand and with an IP67 waterproof rating and shock-resistant casing. Meters can be used for long periods, even in dark places, making it ideal for field measurements in rivers and lakes.



### Pocket Meters

Analyzing water quality is simplified when using our LAQUAtwin range of meters. Designed to produce accurate and reliable results. Anyone, anywhere, at any time can measure samples easily with a LAQUAtwin meter. See just how good they are at our website.



**Application Notes**  
LAQUAtwin pocket meters offer quick and convenient alternative to analyze important parameters with high accuracy. Several application notes are available at (<http://goo.gl/znwE6j>) detailing the use of LAQUAtwin and the results achieved for the respective applications. Additional application notes will be added when available.

## SUPPORT HORIBA CUSTOMER SUPPORT SYSTEM

HORIBA offers a variety of services to conform to quality standards and international guidelines such as GLP, GMP and ISO

**Technical Support**  
Please contact us with any technical questions about our products.  
[www.horiba.com/wq/support](http://www.horiba.com/wq/support)

**User Support**  
Our support website is available for registered customers and features:  
• Data collection software  
• Instruction manual downloads  
• Measurement tips, etc.  
[www.horiba.co.jp/register](http://www.horiba.co.jp/register)

**Validation Support**  
Please contact us with any questions or requirements for your validation procedure.  
• Traceability certification\*  
• IQ/OQ/PQ support\*  
• SOP guidance  
• FAQ  
\*Optional services

 Please read the operation manual before using this product to assure safe and proper handling of the product.

- The contents of this catalog are subject to change without prior notice, and without any subsequent liability to this company.
- The color of the actual products may differ from the color pictured in this catalog due to printing limitations.
- It is strictly forbidden to copy the content of this catalog in part or in full.
- All brand names, product names and service names in this catalog are trademarks or registered trademarks of their respective companies.
- Windows is a registered trademark of Microsoft Corporation in the United States and other countries.
- Complies with all ACMA RCM compliance requirements EMC Systems Doc Number: C160104-2 

<http://www.horiba.com> e-mail: [labinfo@horiba.com](mailto:labinfo@horiba.com)

**HORIBA Instruments Incorporation**  
9755 Research Drive  
Irvine, CA 92618 U.S.A.  
Tel: +1 (949) 250-4811  
Fax: +1 (949) 250-0924



Brochure HBTC-EN-03-2018B