



IsoTrans 36/37

For hazardous/safe area separation of 0 ... 20 mA standard signals without power supply.

The Task

Hazardous area normally means systems in continuous operation that require highly reliable components. Signal transmission to the controller outside the hazardous area must be very accurate to ensure optimal process control.

The Problems

Often, complex systems with power supplies are used for reliable hazardous/safe-area separation combined with electrical isolation to prevent measurement errors.

The Solution

Knick loop-powered isolators for 0(4) ... 20 mA signal transmission. These modules are available as hazardous-area input and hazardous-area output isolators. Due to their patented design (German patent 3526997), they are considered to be the most reliable solution for isolating standard signals without an external power supply.

The Advantages

The IsoTrans 36 and 37 isolators are not only suitable as highly reliable isolators for normal applications, they also meet the most stringent requirements that can be set for electrical isolation. There is no need for power supply wiring.

The Technology

The pioneering TransShield technology allows specifications that were previously considered to be unattainable:

- Extremely high accuracy
- Protective separation, transient protection
- 10 kV test voltage (optional)
- High electromagnetic compatibility
- Extremely low residual ripple and common-mode interference
- Outstanding pulse formation
- High transmission accuracy
- SMART transmission
- Hazardous/safe area separation

In addition to the analog signals, they also transmit data protocols for SMART transmitters (HART). They allow for bidirectional communication from every point of the wiring.

Special model available! Measure voltage without a power supply

Voltages in the range from 250 to 1200 V DC can be converted into current signals up to 5 mA using a special loop-powered version of this isolator. As an example, this allows for easy checking of the contact wire voltage. Please contact us if you need detailed information on this special model.

IsoTrans 36/37

Facts and Features

- **Galvanic isolation between input and output signal**
Protection against measuring errors caused by grounding problems and parasitic interference voltages
- **High transmission accuracy**
Excellent pulse formation due to exact transmission of measured values
- **Protective separation according to EN 61140**
Protection of maintenance staff and subsequent devices against excessively high voltages
- **No power supply required**
Cost savings due to lower wiring effort, no mains influences
- **Very low common-mode interference**
Prevention of incorrect measurements or failures caused by interference
- **SMART transmission**
Bi-directional point-to-point transmission of digital data according to the HART specification
- **Very low residual ripple**
No interference of the connected measuring or control system
- **Maximum reliability**
No repair and failure costs
- **5-year warranty**
- **Explosion protection according to ATEX**
- **10 kV test voltage**
(optional)





ProLine

Interface Technology

Loop-Powered Isolators for Standard Signals (Ex)

Product Line

Devices

		Order no.
IsoTrans 36	Intrinsically safe input	36 A7
IsoTrans 37	Intrinsically safe output	37 A7
IsoTrans 36 A9, special model	Passive voltage measurement, details upon request	36 A9-xxx

Power supply

None, supply from input signal

Options

		Order no.
Increased test voltage	10 kV AC	471

Specifications

Input data

	36 A7	37 A7
Input ¹⁾	0 ... 20 mA, intrinsically safe	0 ... 20 mA
Min. operating current	≤ 20 μA	
Overload capacity	50 mA	
Voltage drop	Approx. 4.5 V at 20 mA ²⁾	Approx. 4 V at 20 mA

Output data

Output	0 ... 20 mA, max. 10 V corresponds to a 500 ohm load)	0 ... 20 mA, max. 20 V, intrinsically safe (corresponds to a 1000 ohm load)
Load error	< 0.15 % meas. val. per 100 ohm load	
Offset	< 20 μA	
Residual ripple V_{rms}	< 10 mV at 20 mA and 500 ohm load	

Transmission behavior

Transmission error	0.2 % meas. val.
Rise or fall time	≤ 400 μs at 500 ohm load 10 ... 90 %, jump from 0 ... 20 mA or 20 ... 0 mA)
HART attenuation	< 10 dB

IsoTrans 36/37

Specifications (continued)

Isolation

Test voltage	4.4 kV AC 10 kV AC with option 471
Working voltages (basic insulation)	3600 V AC/DC, 2500 V AC/DC ³⁾ with overvoltage category II and pollution degree 2 according to EN 61010-1 For applications with high working voltages, take measures to prevent accidental contact and make sure that there is sufficient distance or insulation between adjacent devices. Permissible working voltages for other overvoltage categories and pollution degrees on request. The maximum working voltage for use in hazardous areas is 250 V.
Protection against electric shock	Protective separation to EN 61140 by reinforced insulation according to EN 61010-1. Working voltages with overvoltage category II and pollution degree 2: 600 V AC/DC For applications with high working voltages, take measures to prevent accidental contact and make sure that there is sufficient distance or insulation between adjacent devices. The maximum working voltage for use in hazardous areas is 250 V.

Standards and approvals

	36 A7	37 A7
Explosion protection	II (1) G [EEx ia] IIC, intrinsically safe input PTB 02 ATEX 2134 See the type examination certificate for further specifications	II (2) G [EEx ib] IIC, intrinsically safe output PTB 02 ATEX 2063
EMC ⁴⁾	EN 61326-1, NAMUR NE 21	

Further data

Ambient temperature	Operation: -10 ... +50 °C Transport and storage: -30 ... +80 °C
Ambient conditions	Indoor use ⁵⁾ Relative humidity 5 ... 95 %, no condensation; max. altitude 2000 m (air pressure: 790 ... 1060 hPa) ⁶⁾
Design	Modular housing, 22.5 mm wide, screw terminals. See dimension drawings for further measurements
Tightening torque	0.6 Nm
Ingress protection	Housing: IP 20, terminals: IP 20
Mounting	With snap-on mounting for 35 mm DIN rail according to EN 60715
Connection	Captive terminal screws M 3 x 8 ; box-type terminals with self-raising wire protection, max. conductor cross section: 1 x 4 mm ² solid 1 x 2.5 mm ² stranded with ferrule 2 x 1.5 mm ² stranded with ferrule Only trained and qualified personnel may perform installation, commissioning, and maintenance!
Weight	Approx. 120 g

¹⁾ Linear transmission of IsoTrans 36 bis 50 mA, IsoTrans 37 bis 22 mA

²⁾ Approx. 8.5 V at 50 mA

³⁾ For circuits according to table 6 in EN 61010-1 (fast transients 2600 V)

⁴⁾ Over the range of 1 mA ... 20 mA

⁵⁾ Closed, weather-protected operating areas (stationary operation), water or wind-driven precipitation (rain, snow, hail, etc.) excluded

⁶⁾ Lower air pressure reduces the allowable working voltages.



Block Diagrams

IsoTrans 36 A7

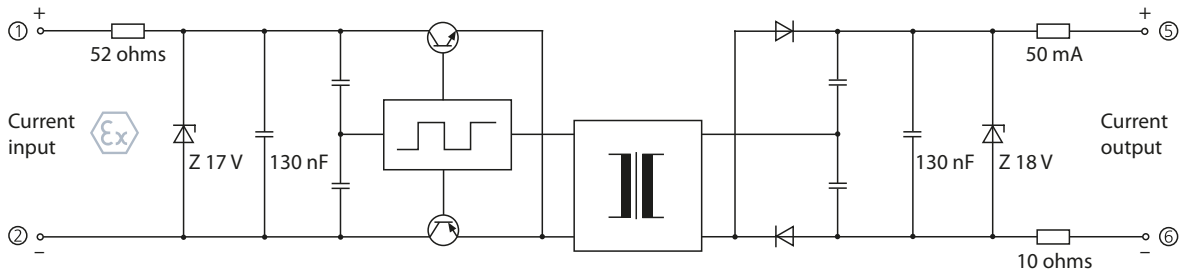

IsoTrans 37 A7

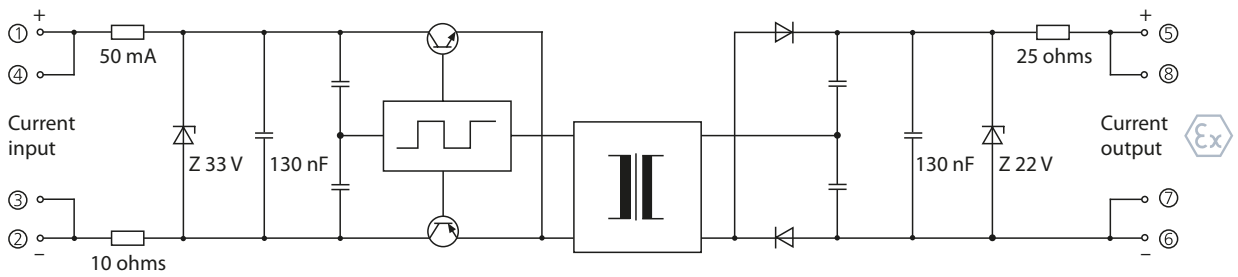

IsoTrans 36/37

Typical Applications IsoTrans 36 A7

Without HART Communication

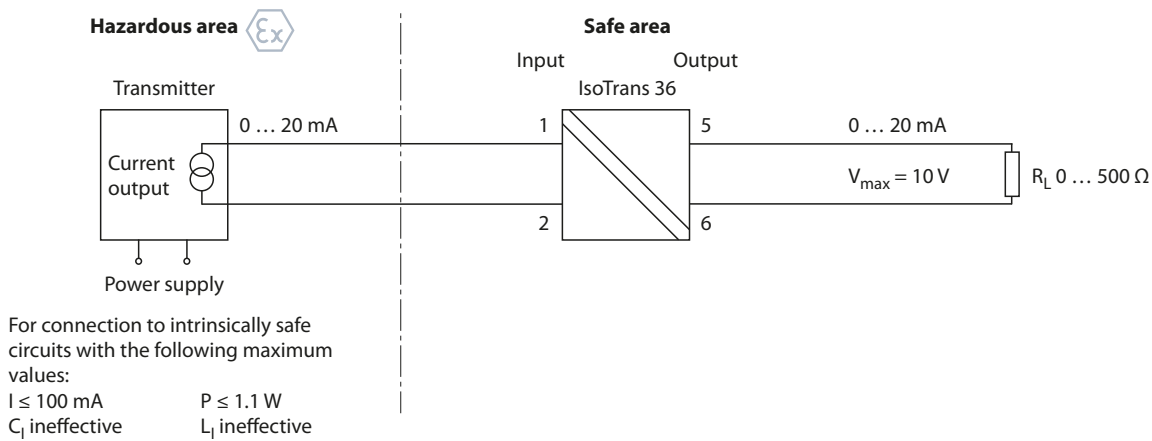

With HART Communication

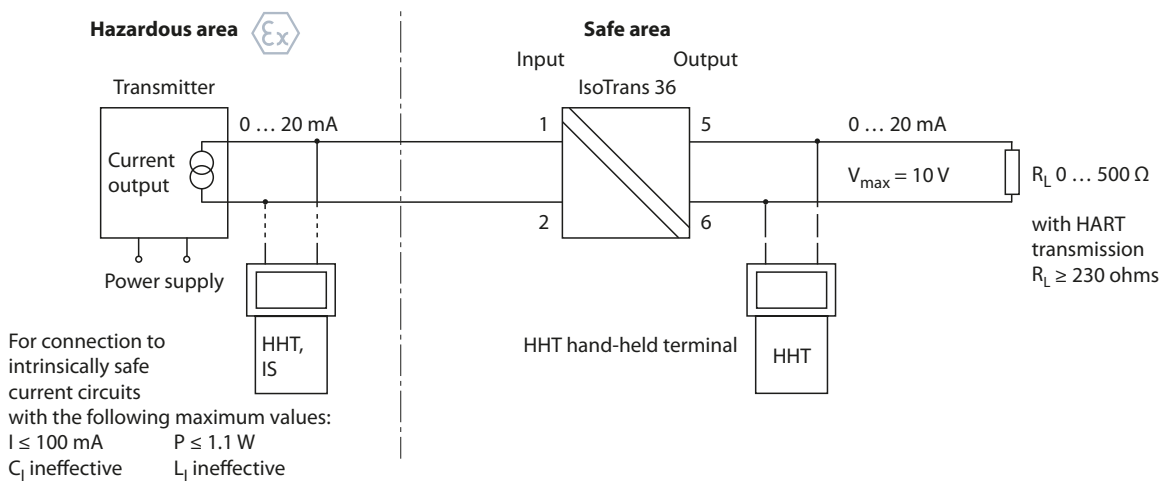



ProLine Interface Technology

Loop-Powered Isolators for Standard Signals (Ex)

Typical Applications IsoTrans 37 A7

Without HART Communication

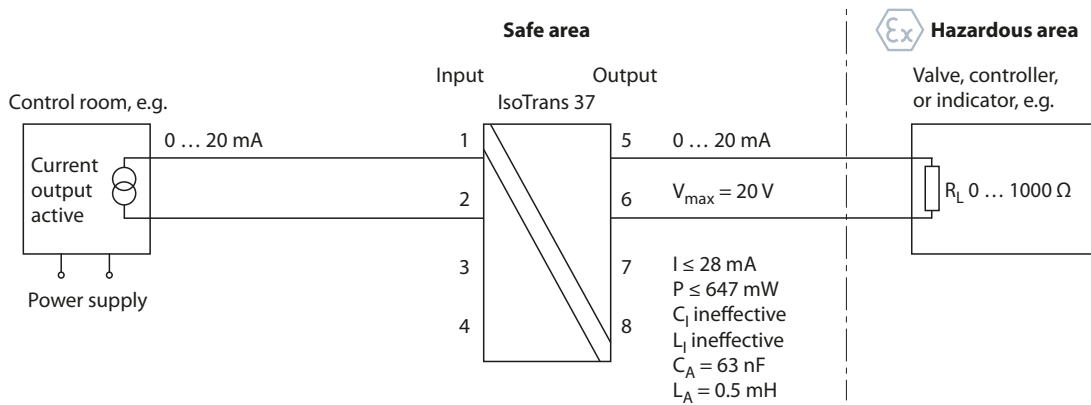

With HART Communication

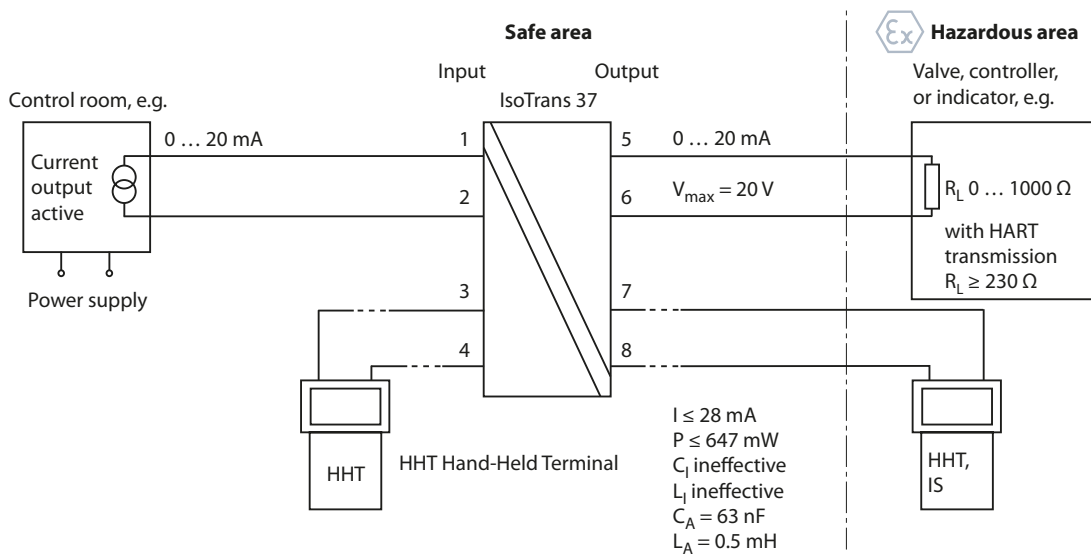

IsoTrans 36/37

Dimension Drawing and Terminal Assignments

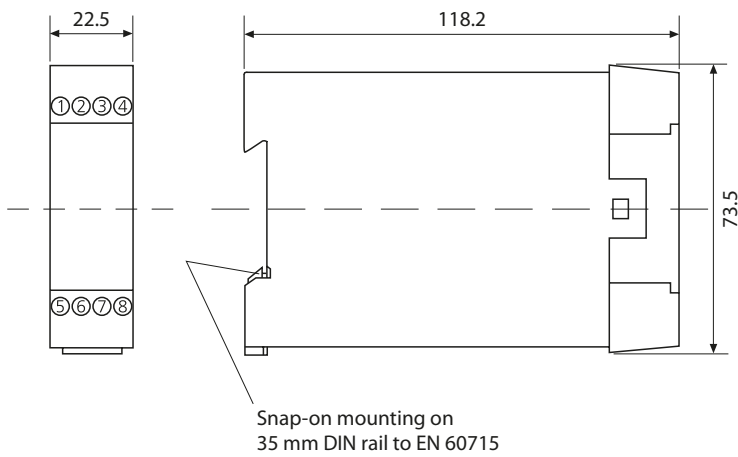

IsoTrans 36 A7

- 1 Input +
- 2 Input -
- 5 Output +
- 6 Output -

IsoTrans 37 A7

- 1 Input +
- 2 Input -
- 3 HHT not intrinsically safe
- 4 HHT not intrinsically safe
- 5 Output +
- 6 Output -
- 7 HHT intrinsically safe
- 8 HHT intrinsically safe

HHT = Hand-Held Terminal

Captive terminal screws M 3 x 8
Box-type terminals with
self-raising wire protection,
max. conductor cross-section
1 x 4 mm² solid;
1 x 2.5 mm² stranded with ferrule;
2 x 1.5 mm² stranded with ferrule

Only trained and qualified personnel may
perform installation, commissioning, and
maintenance!

All dimensions in mm