

Water Distribution Monitor TW-150

Instruction Manual

CODE:GZ0000614905

Preface

This manual describes the operation of the Water Distribution Monitor, TW-150.

Be sure to read this manual before using the product to ensure proper and safe operation of the product. Also safely store the manual so it is readily available whenever necessary.

Product specifications and appearance, as well as the contents of this manual are subject to change without notice.

Warranty and responsibility

HORIBA Advanced Techno, Co., Ltd. warrants that the Product shall be free from defects in material and workmanship and agrees to repair or replace free of charge, at option of HORIBA Advanced Techno, Co., Ltd., any malfunctioned or damaged Product attributable to responsibility of HORIBA Advanced Techno, Co., Ltd. for a period of one (1) year from the delivery unless otherwise agreed with a written agreement. In any one of the following cases, none of the warranties set forth herein shall be extended;

- Any malfunction or damage attributable to improper operation
- Any malfunction attributable to repair or modification by any person not authorized by HORIBA Advanced Techno, Co., Ltd.
- Any malfunction or damage attributable to the use in an environment not specified in this manual
- Any malfunction or damage attributable to violation of the instructions in this manual or operations in the manner not specified in this manual
- Any malfunction or damage attributable to any cause or causes beyond the reasonable control of HORIBA Advanced Techno, Co., Ltd. such as natural disasters
- Any deterioration in appearance attributable to corrosion, rust, and so on
- Replacement of consumables

HORIBA Advanced Techno, Co., Ltd. SHALL NOT BE LIABLE FOR ANY DAMAGES RESULTING FROM ANY MALFUNCTIONS OF THE PRODUCT, ANY ERASURE OF DATA, OR ANY OTHER USES OF THE PRODUCT.

Trademarks

CompactFlash is a registered trademark or trademark of SanDisk Corporation in the United States and other countries.

Other company names and brand names are either registered trademarks or trademarks of the respective companies. (R), (TM) symbols may be omitted in this manual.

Regulations

EU Regulations

■ Conformable Directive

This equipment conforms to the following standards:



EMC: EN61326-1
Class A, Industrial electromagnetic environment
Safety: EN61010-1
RoHS: EN IEC 63000
9. Monitoring and control instruments including industrial monitoring and control instruments

Warning: This is a Class A product. In a domestic environment this product may cause radio interference in which case the user may be required to take adequate measures.

Note

When the sensor cable, the transmission cable, or the contact input cable is extended to 30 m or longer, the surge test specified in the EMC directive for CE marking is not applied.

■ Installation environment

This product is designed for the following environment.

- Overvoltage category II
- Pollution degree 2

■ Information on disposal of electrical and electronic equipment and disposal of batteries and accumulators

The crossed out wheeled bin symbol with underbar shown on the product or accompanying documents indicates the product requires appropriate treatment, collection and recycle for waste electrical and electronic equipment (WEEE) under the Directive 2012/19/EU, and/or waste batteries and accumulators under the Directive 2006/66/EC in the European Union. The symbol might be put with one of the chemical symbols below. In this case, it satisfies the requirements of the Directive 2006/66/EC for the object chemical.

This product should not be disposed of as unsorted household waste.

Your correct disposal of WEEE, waste batteries and accumulators will contribute to reducing wasteful consumption of natural resources, and protecting human health and the environment from potential negative effects caused by hazardous substance in products.

Contact your supplier for information on applicable disposal methods.

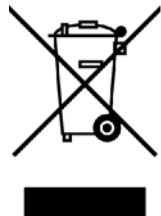

FCC rules

■ FCC compliance statement

This device complies with part 15 of the FCC Rules. Operation is subject to the following two conditions: (1) This device may not cause harmful interference, and (2) this device must accept any interference received, including interference that may cause undesired operation.

■ Responsible party for FCC matter

HORIBA Instruments Incorporated
Head Office
9755 Research Drive
Irvine, California 92618 USA
+1 949 250 4811

■ Note

This equipment has been tested and found to comply with the limits for a Class A digital device, pursuant to part 15 of the FCC Rules. These limits are designed to provide reasonable protection against harmful interference when the equipment is operated in a commercial environment. This equipment generates, uses, and can radiate radio frequency energy and, if not installed and used in accordance with the instruction manual, may cause harmful interference to radio communications. Operation of this equipment in a residential area is likely to cause harmful interference in which case the user will be required to correct the interference at his own expense.

Any changes or modifications not expressly approved by the party responsible for compliance could void the user's authority to operate the equipment

Korea certification

A급 기기 (업무용 방송통신기자재)

이 기기는 업무용(A급) 전자파적합기기로서 판매자 또는 사용자는 이 점을 주의하시기 바라며, 가정외의 지역에서 사용하는 것을 목적으로 합니다.

Taiwan battery recycling mark



廢電池請回收

For Your Safety

Hazard classification and warning symbols

Warning messages are described in the following manner. Read the messages and follow the instructions carefully.

■ Hazard classification



DANGER

This indicates an imminently hazardous situation which, if not avoided, will result in death or serious injury. This is to be limited to the most extreme situations.



WARNING

This indicates a potentially hazardous situation which, if not avoided, could result in death or serious injury.



CAUTION

This indicates a potentially hazardous situation which, if not avoided, may result in minor or moderate injury. It may also be used to alert against unsafe practices.

■ Warning symbols



Description of what should be done, or what should be followed



Description of what should never be done, or what is prohibited

Safety label list

The following table lists the labels attached on the product.

For more details, refer to the descriptions of the individual labels provided later in this manual.

Hazard level	Hazard type	Label ID number
DANGER	ELECTRIC SHOCK	3200644218
WARNING	ELECTRIC SHOCK	3200642164

The following pages describe the safety information in German, French, Italian, Swedish, Spanish, Polish, Dutch, and Japanese (8 languages), and the safety labels affixed to the product (9 languages, including the above and English).

[DEU] Sicherheitsinformation

Lesen Sie vor der Verwendung des Produkts unbedingt diese Anleitung, um den ordnungsgemäßen und sicheren Betrieb des Produkts zu gewährleisten. Bewahren Sie die Anleitung sicher auf, damit sie bei Bedarf jederzeit zur Hand ist.

Die technischen Daten und das Erscheinungsbild des Produkts sowie der Inhalt dieser Anleitung können unangekündigt geändert werden.

■ Installationsumgebung

Dies ist ein Produkt der Klasse A gemäß EN61326-1, welches in einer Wohnumgebung Radiostörungen verursachen kann. In diesem Fall muss der Nutzer entsprechende Gegenmaßnahmen ergreifen.

Das Produkt ist gemäß EN61010-1 für die folgende Umgebung vorgesehen.

- Überspannungskategorie II
- Verschmutzungsgrad 2

■ Gefahrenklassifikation und Warnsymbole

Warnmeldungen werden wie folgt beschrieben. Lesen Sie die Meldungen und befolgen Sie die Anleitungen sorgfältig.



GEFAHR

Dies weist auf eine unmittelbar gefährliche Situation hin, die im Tod oder in schweren Verletzungen resultiert, falls sie nicht vermieden wird. Dies ist auf die extremsten Situationen zu begrenzen.



WARNUNG

Dies weist auf eine potentiell gefährliche Situation hin, die im Tod oder in schweren Verletzungen resultieren könnte, falls sie nicht vermieden wird.



VORSICHT

Dies weist auf eine potentiell gefährliche Situation hin, die in leichten oder mäßigen Verletzungen resultieren könnte, falls sie nicht vermieden wird. Sie kann auch zur Warnung vor unsicheren Praktiken verwendet werden.

■ Liste der Sicherheitsschilder

Die folgende Tabelle listet die am Produkt befestigten Schilder auf.

Weitere Details entnehmen Sie den Beschreibungen der individuellen Schilder weiter hinten in dieser Anleitung.

Gefahrenstufe	Gefahrentyp	Schild-ID-Nummer
GEFAHR	STROMSCHLAG	3200644218
WARNUNG	STROMSCHLAG	3200642164

[FRA] Informations de sécurité

Veillez à lire le présent manuel avant d'utiliser le produit de manière à garantir son utilisation correcte et sûre. De même, rangez le manuel dans un lieu sûr de manière à pouvoir vous y reporter lorsque cela est nécessaire.

Les spécifications et l'aspect du produit, ainsi que le contenu du présent manuel peuvent être modifiés sans notification préalable.

■ Environnement d'installation

Ceci est un produit de classe A, tel que défini dans la norme EN61326-1. Dans un environnement domestique, ce produit peut causer des interférences radio, auquel cas l'utilisateur peut être amené à prendre des mesures adéquates.

Le produit est conçu pour l'environnement suivant, tel que défini dans la norme EN61010-1.

- Catégorie de surtension II
- Degré de pollution 2

■ Classification des risques et symboles d'avertissement

Les messages d'avertissement sont décrits comme suit. Lisez les messages et suivez attentivement les instructions.



DANGER

Cela indique une situation dangereuse imminente qui, si elle n'est pas évitée, entraînera la mort ou des blessures graves. Cela fait uniquement référence aux situations les plus extrêmes.



AVERTISSEMENT

Cela indique une situation potentiellement dangereuse qui, si elle n'est pas évitée, peut entraîner la mort ou des blessures graves.



ATTENTION

Cela indique une situation potentiellement dangereuse qui, si elle n'est pas évitée, peut entraîner des blessures mineures ou modérées. Cela peut également être utilisé pour signaler des pratiques dangereuses.

■ Liste des étiquettes de sécurité

Le tableau suivant répertorie les étiquettes fixées sur le produit.

Pour plus de détails, reportez-vous aux descriptions des étiquettes individuelles fournies ultérieurement dans ce manuel.

Niveau de risque	Type de risque	Numéro d'identification de l'étiquette
DANGER	DÉCHARGE ÉLECTRIQUE	3200644218
AVERTISSEMENT	DÉCHARGE ÉLECTRIQUE	3200642164

[ITA] Informazioni sulla sicurezza

Leggere attentamente questo manuale prima di utilizzare il prodotto al fine di utilizzarlo in modo sicuro e adeguato. Inoltre, conservare in un luogo sicuro il manuale per poterlo consultare se necessario.

Le specifiche e l'aspetto del prodotto, nonché i contenuti di questo manuale, sono soggetti a modifica senza preavviso.

■ Ambiente di installazione

Questo è un prodotto di classe A, definito secondo lo standard EN61326-1. Se utilizzato in un ambiente domestico il prodotto può causare interferenze radio, nel qual caso è possibile che l'utente debba prendere provvedimenti adeguati.

Il prodotto è designato per il seguente ambiente, definito nello standard EN61010-1.

- Categoria di sovratensione II
- Livello di inquinamento 2

■ Categoria di pericolo e simboli di avvertenza

I messaggi di avvertenza sono descritti come segue. Leggere i messaggi e seguire con attenzione le istruzioni.



PERICOLO

Indica un pericolo immediato che, se non evitato, può causare il decesso o lesioni gravi. Limitato alle situazioni più estreme.



AVVERTENZA

Indica una situazione potenzialmente pericolosa che, se non evitata, potrebbe causare il decesso o lesioni gravi.



ATTENZIONE

Indica una situazione potenzialmente pericolosa che, se non evitata, potrebbe causare lesioni di media e piccola entità. Potrebbe essere usato anche per informare circa pratiche non sicure.

■ Elenco etichette di sicurezza

La tabella seguente elenca le etichette applicate sul prodotto.

Per maggiori informazioni, consultare la descrizione di ciascuna etichetta più avanti nel presente manuale.

Livello di pericolo	Tipo di pericolo	Numero ID etichetta
PERICOLO	SCOSSE ELETTRICHE	3200644218
AVVERTENZA	SCOSSE ELETTRICHE	3200642164

[SWE] Säkerhetsinformation

Se till att du läser denna handbok innan du börjar använda produkten för en korrekt och säker användning av den. Spara sedan handboken på en säker och lättåtkomlig plats så att du kan konsultera den när så behövs.

Produktspecifikationerna och utseendet, samt även innehållet i denna handbok, kan komma att ändras utan föregående meddelande därom.

■ Installationsmiljö

Detta är en Klass A-produkt som uppfyller kraven i SS-EN 61326-1. Om den används i hemmiljö kan denna enhet orsaka radiostörningar. Om detta sker kan användaren behöva vidta lämpliga åtgärder för att lösa detta problem.

Produkten är utformad för användning i följande miljöer, i enlighet med SS-EN 61010-1.

- Överspänningskategori II
- Föroreningsgrad 2

■ Riskklassificering och varningssymboler

Varningsmeddelandena beskrivs på följande sätt. Läs meddelandena och följ anvisningarna noggrant.



FARA

Denna varnar för en omedelbart risksituation som kan orsaka allvarliga personskador eller dödsfall om den inte följs. Detta omfattar endast de mest extrema situationerna.



VARNING

Denna varnar för en potentiell risksituation som kan orsaka allvarliga personskador eller dödsfall om den inte följs.



OBSERVER

Denna varnar för en potentiell risksituation som kan orsaka mindre person- eller materialskador om den inte följs. Den kan även användas för att indikera olämplig användning.

■ Lista över säkerhetsetiketter

I följande tabell listas de etiketter som sitter fastsatta på produkten.

Läs beskrivningarna för varje enskild etikett som finns längre fram i handboken för mer information.

Risknivå	Risktyp	Etikett-ID-nummer
FARA	ELEKTRISKA STÖTAR	3200644218
VARNING	ELEKTRISKA STÖTAR	3200642164

[SPA] Información de seguridad

Asegúrese de leer este manual antes de utilizar el producto para garantizar un uso correcto y seguro del mismo. Asimismo, guarde de forma segura el manual para que esté disponible siempre que sea necesario.

El aspecto y las especificaciones del producto, así como el contenido de este manual, están sujetos a cambios sin previo aviso.

■ Entorno de instalación

Este es un producto de Clase A, definido en EN61326-1. En un entorno doméstico este producto puede provocar interferencias de radio, en cuyo caso el usuario puede tener que tomar las medidas pertinentes.

El producto se ha diseñado para el siguiente entorno, definido en EN61010-1.

- Categoría de sobretensión II
- Nivel de contaminación 2

■ Clasificación de peligrosidad y símbolos de advertencia

Los mensajes de advertencia se describen de la siguiente manera. Lea los mensajes y siga las instrucciones atentamente.



PELIGRO

Esto indica una situación de peligro inminente que, si no se evita, tendrá como resultado la muerte o lesiones graves. Esto se debe limitar a las situaciones más extremas.



ADVERTENCIA

Esto indica una posible situación de peligro que, si no se evita, podría tener como resultado la muerte o lesiones graves.



ATENCIÓN

Esto indica una posible situación de peligro que, si no se evita, puede tener como resultado lesiones leves o moderadas. También se puede usar para alertar de prácticas no seguras.

■ Lista de etiquetas de seguridad

En la siguiente tabla se muestran las etiquetas adheridas al producto.

Para obtener más información, consulte las descripciones de las etiquetas individuales que se proporcionan más adelante en este manual.

Nivel de riesgo	Tipo de riesgo	Número de ID de etiqueta
PELIGRO	DESCARGA ELÉCTRICA	3200644218
ADVERTENCIA	DESCARGA ELÉCTRICA	3200642164

[POL] Informacje dotyczące bezpieczeństwa

Przed przystąpieniem do użytkowania tego produktu należy dokładnie zapoznać się z niniejszą instrukcją, aby zapewniona była prawidłowa i bezpieczna eksploatacja produktu. Instrukcję przechowywać w bezpiecznym miejscu, aby w razie potrzeby była zawsze dostępna.

Specyfikacja i wygląd produktów oraz treść niniejszej instrukcji może ulec zmianie bez wcześniejszego powiadomienia.

■ Środowisko instalacji

Jest to produkt klasy A, zgodnie z definicją określoną w normie EN61326-1. W warunkach domowych produkt ten może powodować zakłócenia radiowe; w takiej sytuacji od użytkownika może być wymagane podjęcie stosownych działań.

Produkt jest przeznaczony do użycia w poniższym środowisku zdefiniowanym w normie EN61010-1.

- Kategoria przepięciowa II
- Stopień zanieczyszczenia 2

■ Klasyfikacja zagrożeń i symbole ostrzegawcze

Ostrzeżenia są opisane w następujący sposób. Należy zapoznać się z ostrzeżeniami i ściśle przestrzegać instrukcji.



NEBEZPIECZEŃSTWO

Oznacza bezpośrednio niebezpieczną sytuację, która — jeśli do niej dojdzie — spowoduje zgon lub poważne obrażenia ciała. To ostrzeżenie dotyczy najbardziej skrajnych sytuacji.



OSTRZEŻENIE

Oznacza potencjalnie niebezpieczną sytuację, która — jeśli do niej dojdzie — może spowodować zgon lub poważne obrażenia ciała.



PRZESTROGA

Oznacza potencjalnie niebezpieczną sytuację, która — jeśli do niej dojdzie — może spowodować niewielkie lub umiarkowane obrażenia ciała. Ten rodzaj ostrzeżenia może także być używany do ostrzegania przed niebezpiecznymi sposobami postępowania.

■ Lista etykiet bezpieczeństwa

W poniższej tabeli wymieniono etykiety umieszczone na produkcie.

Bardziej szczegółowe informacje można znaleźć w opisach poszczególnych etykiet, które znajdują się w dalszej części niniejszej publikacji.

Poziom zagrożenia	Typ zagrożenia	Numer identyfikacyjny etykiety
NIEBEZPIECZEŃSTWO	PORAŻENIE ELEKTRYCZNE	3200644218
OSTRZEŻENIE	PORAŻENIE ELEKTRYCZNE	3200642164

[NLD] Veiligheidsinformatie

Lees deze handleiding voordat u dit product gebruikt zodat u het op de juiste manier en veilig kunt gebruiken. Bewaar de handleiding goed zodat u hem wanneer nodig kunt raadplegen.

De specificaties en het uiterlijk van het product en de inhoud van deze handleiding kunnen zonder voorafgaande kennisgeving worden gewijzigd.

■ Installatieomgeving

Dit is een product van klasse A, gedefinieerd in EN 61326-1. In een huishoudelijke omgeving kan dit product radio-interferentie veroorzaken, en in dat geval moet de gebruiker mogelijk maatregelen treffen om de storing te verhelpen.

Het product is ontworpen voor de volgende omgeving, gedefinieerd in EN 61010-1.

- Overspanningscategorie II
- Vervuilingsgraad 2

■ Indeling naar gevarencategorie en waarschuwingssymbolen

De waarschuwingen hebben de volgende betekenis. Lees de uitleg en volg de instructies aandachtig.



GEVAAR

Dit wijst op een onmiddellijk gevaarlijke situatie die zal leiden tot dodelijk of ernstig letsel als die niet wordt vermeden. Dit wordt alleen in de meest extreme gevallen gebruikt.



WAARSCHUWING

Dit wijst op een mogelijk gevaarlijke situatie die kan leiden tot dodelijk of ernstig letsel als die niet wordt vermeden.



VOORZICHTIG

Dit wijst op een mogelijk gevaarlijke situatie die kan leiden tot klein of matig letsel als die niet wordt vermeden. Dit kan ook gebruikt worden als waarschuwing tegen onveilig gebruik.

■ Lijst van veiligheidslabels

In de volgende tabel worden de labels vermeld die op het product zijn aangebracht. Raadpleeg voor meer details de beschrijving van de afzonderlijke labels verder in deze handleiding.

Risiconiveau	Risicotype	ID-nummer van label
GEVAAR	ELEKTRISCHE SCHOK	3200644218
WAARSCHUWING	ELEKTRISCHE SCHOK	3200642164

[JPN] 安全情報

ご使用になる前に、本書を必ずお読みください。お読みになった後は必要なときにすぐに取り出せるように大切に保管してください。

ご使用の際、安全に関してお気付きの点がありましたら、弊社にご連絡ください。

製品の仕様・外観は、改良のため予告なく変更することがあります。

また、本書に記載されている内容も予告なく変更される場合があります。あらかじめご了承ください。

■ 設置環境

本製品は、EN61326-1で定義されるクラスA(工業環境用)製品です。

家庭環境においては、無線妨害を生ずることがあり、その場合には使用者が適切な対策を講ずることが必要となる場合があります。

本製品は、EN61010-1で定義される以下の環境用に設計されています。

- 過電圧カテゴリ-II
- 汚染度2

■ 警告の種類と表示方法

本書および製品では、以下のような警告表示をしています。内容をよく理解して、正しく安全にご使用ください。



危険

取り扱いを誤った場合、使用者が死亡または重傷を負うことがあり、かつその切迫の度合いが高いもの



警告

取り扱いを誤った場合、使用者が死亡または重傷を負う可能性が想定されるもの



注意

取り扱いを誤った場合、使用者が傷害を負うことが想定されるか、または物的損害の発生が想定されるもの

■ 安全ラベル一覧

製品には以下の安全ラベルが貼り付けられています。

安全ラベルの内容については、後述の各ラベルの説明を参照してください。

危険レベル	危険の種類	ラベル識別番号
危険	感電	3200644218
警告	感電	3200642164



3200644218

[ENG]	
DANGER	<p>ELECTRIC SHOCK To prevent electric shock, turn the power switch OFF when opening. Open only when necessary. Perform work according to the Service Manual.</p>
ELECTRIC SHOCK	
For service personnel	
[DEU]	
GEFAHR	<p>STROMSCHLAG Zur Verhinderung eines Stromschlags den Stromschalter beim Öffnen auf AUS stellen. Nur öffnen, wenn erforderlich. Die Arbeiten gemäß der Wartungsanleitung ausführen.</p>
STROMSCHLAG	
Für das Wartungspersonal	
[FRA]	
DANGER	<p>DÉCHARGE ÉLECTRIQUE Pour éviter toute décharge électrique, désactivez l'interrupteur avant d'ouvrir. N'ouvrez que lorsque cela est nécessaire. Effectuez les travaux conformément au manuel d'entretien.</p>
DÉCHARGE ÉLECTRIQUE	
Pour le personnel d'entretien	
[ITA]	
PERICOLO	<p>SCOSSE ELETTRICHE Per evitare scosse elettriche, spegnere il dispositivo quando è aperto. Aprirlo solo se necessario. Eseguire il lavoro seguendo le istruzioni del Manuale di manutenzione.</p>
SCOSSE ELETTRICHE	
Per il tecnico riparatore	

<p>ELEKTRISKA STÖTAR För att undvika elektriska stötar bör du alltid slå AV strömbrytaren när du öppnar enheten. Öppna endast enheten i undantagsfall. Utför allt arbete i enlighet med anvisningarna i servicehandboken.</p>	[SWE]
	FARA
	ELEKTRISKA STÖTAR
	För servicetekniker
<p>DESCARGA ELÉCTRICA Para evitar una descarga eléctrica, desconecte la alimentación cuando se abra. Ábralo solo cuando sea necesario. Realice el trabajo de acuerdo con el Manual de servicio.</p>	[SPA]
	PELIGRO
	DESCARGA ELÉCTRICA
	Para personal de mantenimiento
<p>PORAŻENIE ELEKTRYCZNE Aby uniknąć porażenia elektrycznego, przed otwarciem ustawić wyłącznik zasilania w położeniu OFF (Wył.). Nie otwierać bez potrzeby. Prace wykonywać zgodnie z Instrukcją serwisową.</p>	[POL]
	NIEBEZPIECZEŃSTWO
	PORAŻENIE ELEKTRYCZNE
	Dla serwisanta
<p>ELEKTRISCHE SCHOK Om een elektrische schok te voorkomen, de hoofdschakelaar uitschakelen voordat het apparaat wordt geopend. Alleen openen wanneer dat noodzakelijk is. Het werk uitvoeren volgens de onderhoudshandleiding.</p>	[NLD]
	GEVAAR
	ELEKTRISCHE SCHOK
	Voor onderhoudspersoneel
<p>感電注意 感電防止のため、開けるときには、電源スイッチをOFFにしてください。 必要なときのみ、開けてください。 サービスマニュアルに従って作業してください。</p>	[JPN]
	危険
	感電
	サービスマン向け



3200642164

[ENG]	
WARNING	<p>ELECTRIC SHOCK When opening, turn the power switch OFF to prevent electric shock. Open only when necessary. Perform work according to the User's Manual.</p>
ELECTRIC SHOCK	
[DEU]	
WARNUNG	<p>STROMSCHLAG Beim Öffnen den Stromschalter auf AUS stellen, um einen Stromschlag zu verhindern. Nur öffnen, wenn erforderlich. Die Arbeiten gemäß der Gebrauchsanleitung ausführen.</p>
STROMSCHLAG	
[FRA]	
AVERTISSEMENT	<p>DÉCHARGE ÉLECTRIQUE Lors de l'ouverture, désactivez l'interrupteur afin d'éviter toute décharge électrique. N'ouvrez que lorsque cela est nécessaire. Effectuez les travaux conformément au manuel d'utilisation.</p>
DÉCHARGE ÉLECTRIQUE	
[ITA]	
AVVERTENZA	<p>SCOSSE ELETTRICHE Al momento dell'apertura, spegnere il dispositivo per evitare scosse elettriche. Aprirlo solo se necessario. Eseguire il lavoro seguendo le istruzioni del Manuale dell'utente.</p>
SCOSSE ELETTRICHE	

<p>ELEKTRISKA STÖTAR För att undvika elektriska stötar bör du alltid slå AV strömbrytaren när du öppnar enheten. Öppna endast enheten i undantagsfall. Utför allt arbete i enlighet med anvisningarna i användarhandboken.</p>	[SWE]
	VARNING
	ELEKTRISKA STÖTAR
<p>DESCARGA ELÉCTRICA Cuando se abra, desconecte la alimentación para evitar una descarga eléctrica. Ábralo solo cuando sea necesario. Realice el trabajo de acuerdo con el Manual del usuario.</p>	[SPA]
	ADVERTENCIA
	DESCARGA ELÉCTRICA
<p>PORAŻENIE ELEKTRYCZNE Przed otwarciem ustawić wyłącznik zasilania w położeniu OFF (Wył.), aby uniknąć porażenia elektrycznego. Nie otwierać bez potrzeby. Prace wykonywać zgodnie z Instrukcją obsługi.</p>	[POL]
	OSTRZEŻENIE
	PORAŻENIE ELEKTRYCZNE
<p>ELEKTRISCHE SCHOK Vóór het openen de hoofdschakelaar uitschakelen om een elektrische schok te voorkomen. Alleen openen wanneer dat noodzakelijk is. Het werk uitvoeren volgens de gebruiksaanwijzing.</p>	[NLD]
	WAARSCHUWING
	ELEKTRISCHE SCHOK
<p>感電注意 感電防止のため、開けるときには電源スイッチをOFFにしてください。 必要なときのみ、開けてください。 取扱説明書に従って作業してください。</p>	[JPN]
	警告
	感電

Safety precautions

This section provides precautions for using the product safely and correctly and to prevent injury and damage. The terms of DANGER, WARNING, and CAUTION indicate the degree of imminency and hazardous situation. Read the precautions carefully as it contains important safety messages.



WARNING



Electric shock

Opening the cover while powered on could result in electric shock. Be sure to turn OFF power prior to opening the cover.



Fire or electric shock

- Do not bundle the power supply cord during use.
- Do not damage the power supply cord nor apply an excessive load to it, such as bending and stretching it repeatedly, putting a heavy thing on it.
- If it can not be plugged into an electrical outlet firmly, stop use of the power supply cord. It may result in overheating, a fire, an electrical shock, or breakdown.



CAUTION



pH sensor is made of glass. Be careful not to break the glass on the top of the sensor.



Chemical caution

Be careful not to drop color span calibration solution on your skin or drink it. If color span calibration solution comes into contact with your skin or eyes, immediately wash away with running water. If you swallow the solution, contact your doctor immediately.

Product Handling Information

Operational precautions

Use of the product in a manner not specified by the manufacturer may impair the protection provided by the product. And it may also reduce product performance.

Exercise the following precautions:

- Use the TW-150 in the temperature range shown in the general specifications.
- Use the TW-150 in an environment free from corrosive gas.
- Avoid using the TW-150 in a location close to equipment using strong electric power (such as an electric furnace), or near a radio or sound wave source.
- Do not give a shock or large vibrations to the TW-150. To move the TW-150 to another location, contact our service or sales office.
- Avoid turning ON the power again immediately after turning it OFF.
- Do not operate touch panel with wet finger or solid tools, such as pen or driver.

Disposal of the product

When disposing of the product, follow the related laws and/or regulations of your country.

Manual Information

Description in this manual

Note

This interprets the necessary points for correct operation and notifies the important points for handling the product.

Reference

This indicates the part where to refer for information.

Tip

This indicates reference information.

Contents

1	OVERVIEW	1
1.1	Outline	1
1.2	Part Names	2
1.2.1	Device	2
1.2.2	Display	4
2	PREPARATION	6
2.1	Opening the Inner Door of the Device	7
2.2	Installing the pH Sensor	8
2.3	Installing the Conductivity Sensor (optional)	9
2.4	Insert Beads	10
3	OPERATION	11
3.1	Starting the Device	11
3.2	Stopping the Device	13
3.2.1	When stopping the device for a week or less	13
3.2.2	When stopping the device for a week or more	14
3.3	Restarting the Device	15
3.3.1	When stopping the device for a week or less	15
3.3.2	When stopping the device for a week or more	15
3.4	Maintenance Mode	15
3.5	Precautions for Measurements	16
4	CALIBRATION	17
4.1	Calibration Patterns and Cycles	17
4.2	Precautions for Calibration	21
4.3	Displaying the Calibration Screen	23
4.4	Calibrating pH	24
4.4.1	Individual zero calibration and span calibration <pH>	24
4.4.2	Adjustment calibration using sample water <pH>	29
4.5	Calibrating Color	31
4.5.1	Common zero calibration and span calibration <color>	32
4.5.2	Individual zero calibration and span calibration <color>	37
4.5.3	Adjustment calibration using sample water <color>	40
4.6	Turbidity Calibration	42

4.6.1	Common zero calibration and span calibration < turbidity >	43
4.6.2	Individual zero calibration and span calibration <turbidity>	48
4.6.3	Adjustment calibration using sample water <turbidity>	51
4.7	Conductivity Calibration (Optional)	53
4.7.1	Span calibration <conductivity>	54
4.7.2	Individual zero calibration <conductivity>	57
4.7.3	Adjustment calibration using sample water <conductivity>	60
4.8	Calibrating Residual Chlorine	62
4.8.1	Adjustment calibration using sample water <residual chlorine>	62
4.8.2	<Reference> Common zero calibration and span calibration <residual chlorine>	64
4.8.3	<Reference> Individual zero calibration and span calibration <residual chlorine>	68
4.9	Calibrating Water Pressure	71
4.9.1	Adjustment calibration using sample water <water pressure>	71
4.10	Calibrating Water Temperature	73
4.10.1	Adjustment calibration using sample water <water temperature>	73
5	FUNCTION	75
5.1	Function List	75
5.2	Input/Output Settings	78
5.2.1	Setting EXT I/O IN	79
5.2.2	Setting external output during operation	79
5.2.3	Setting the analog output level	81
5.2.4	Setting DISPLAYING MINUS	81
5.3	Automatic Zero Calibration	82
5.3.1	Setting ON/OFF of ZERO CAL.	82
5.3.2	Setting the calibration interval	83
5.3.3	Setting the STANDARD TIME	83
5.4	Auto Washing	84
5.4.1	Turning auto washing ON and OFF	85
5.4.2	Setting the WASHING INTERVAL	85
5.4.3	Setting the STANDARD TIME	86
5.4.4	Setting the WIPING TIME	86
5.5	Auto Draining	87
5.5.1	Turning auto draining ON and OFF	88
5.5.2	Setting the DRAIN INTERVAL	88
5.5.3	Setting the STANDARD TIME	89
5.5.4	Setting the DRAIN TIME	89
5.5.5	Setting the HOLD TIME	90
5.6	Water Sampling	91
5.6.1	Setting the SAMPLING CHECK	92
5.6.2	Setting the SAMPLING TIME	92

5.6.3	Perform the SAMPLING RESET	93
5.7	Clock Adjustment	94
5.8	LCD Setting	95
5.8.1	Setting the BACK LIGHT TIME	95
5.8.2	Controlling brightness	96
5.9	Touch Panel Adjustment	97
5.10	Measurement Settings	98
5.10.1	Setting the COEFFICIENTS	100
5.10.2	Setting the range for turbidity and color	101
5.10.3	Correcting color using turbidity	102
5.10.4	Setting the applied voltage for residual chlorine	103
5.10.5	Setting the range for residual chlorine	103
5.10.6	Setting the unit for water pressure	104
5.10.7	Setting the range for conductivity (Optional)	104
5.11	Action	105
5.11.1	Performing ACTION operation	106
5.12	Checking the Device Status	107
5.12.1	Displaying the TEMPERATURE screen	107
5.12.2	Displaying the UNIT INFORMATION screen	107
5.12.3	Setting ID	108
5.12.4	Analog input check	109
5.12.5	Analog output check	109
5.13	Data Check	110
5.13.1	Displaying the data history	111
5.13.2	Deleting the data history	112
5.13.3	Displaying a graph	113
5.13.4	Calibration history check	115
5.13.5	Deleting the calibration history	116
5.13.6	Checking flow rate	117
5.13.7	Transferring data to a CF (CompactFlash) card	118
5.13.8	Initializing a CF (CompactFlash) card	118
5.14	Alarm	119
5.14.1	Checking an alarm	120
5.14.2	Canceling an alarm	120
5.14.3	Checking the alarm history	121
5.14.4	Deleting the alarm history	121
5.14.5	Setting the ALARM TIME	122
5.14.6	Setting the HIGH ALARM	123
5.14.7	Setting the LOW ALARM	124
5.14.8	Setting the UNIT HIGH ALARM	125
5.14.9	Setting the UNIT LOW ALARM	126
6	INPUT/OUTPUT	127
6.1	Analog Output	127

6.2	Parallel Input/Output	129
6.2.1	Parallel output	129
6.2.2	Parallel input	130
6.3	Serial Input/Output (RS-232C)	131
6.4	Storing the Data on a CF (CompactFlash) Card	132
7	MAINTENANCE	135
7.1	Maintenance Items	135
7.2	Stopping and Restarting Operation	137
7.3	Connection Locations for the Sensor Connectors	138
7.4	Parts Maintenance and Replacement	140
7.4.1	Replacing the mesh filter	140
7.4.2	Replacing the filter cartridge of the zero water filter	141
7.4.3	Maintenance of the residual-chlorine sensor	142
7.4.4	Replacing and storing the conductivity sensor (optional unit)	144
7.4.5	Replacing and storing the pH sensor	145
7.5	Spare Parts	147
8	TROUBLESHOOTING	148
8.1	Alarm List	148
8.2	Alarm Causes and Corrective Actions	151
9	REFERENCE	162
9.1	Specifications	162
9.2	Piping Flow	165
9.3	Turbidity Measurement	166
9.4	Color Measurement	166
9.5	Residual Chlorine Measurement	167
9.6	pH Measurement	168
9.7	Conductivity Measurement (Optional)	169
9.8	Evaluating Coefficients	170

1 OVERVIEW

1.1 Outline

This product is an automatic water-quality monitoring system that continuously measures water quality at the ending of the feed pipe of the water supply.

The measurement items in the standard configuration are turbidity, color, residual chlorine. You can add conductivity and water temperature as optional measurement items by requesting them when ordering the product.

Note

You can not add the optional measurement items (conductivity, water temperature) after delivery of the product.

Measurement item	Standard configuration	Optional
Turbidity	○	
Color	○	
Residual chlorine	○	
Water pressure	○	
pH	○	
Conductivity		○
Water temperature		○

● Features

- Measurement data can be output through electrical analog outputs to a recorder, or output to a computer using the RS-232C serial connection.
- You can save and read measurement data using a compact flash memory card.

1.2 Part Names

1.2.1 Device

● Front

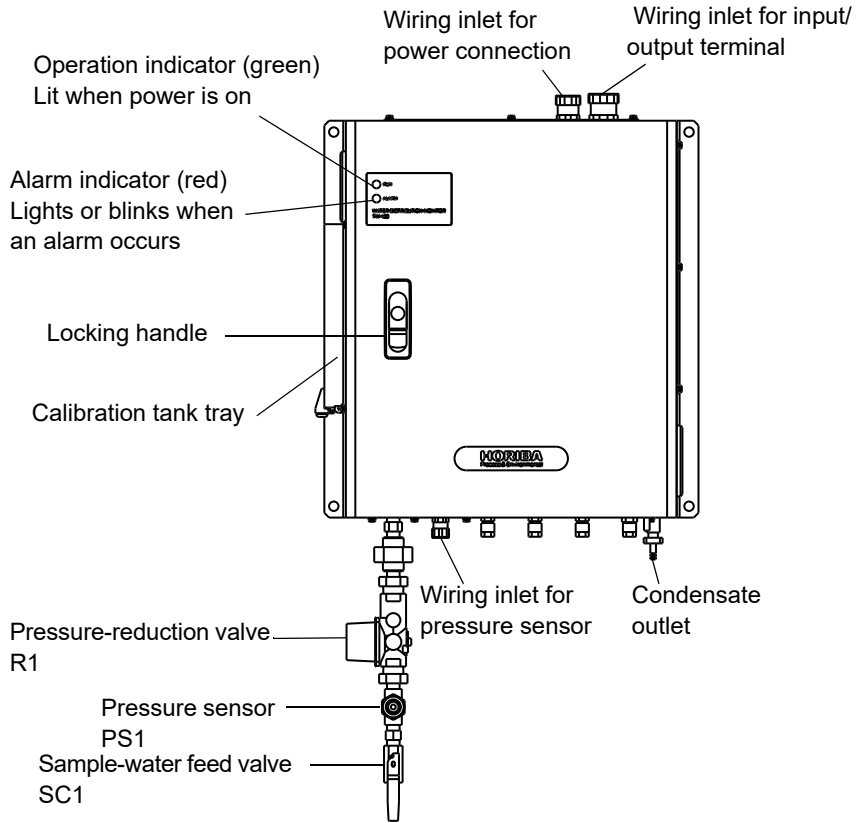

● Front - With door open

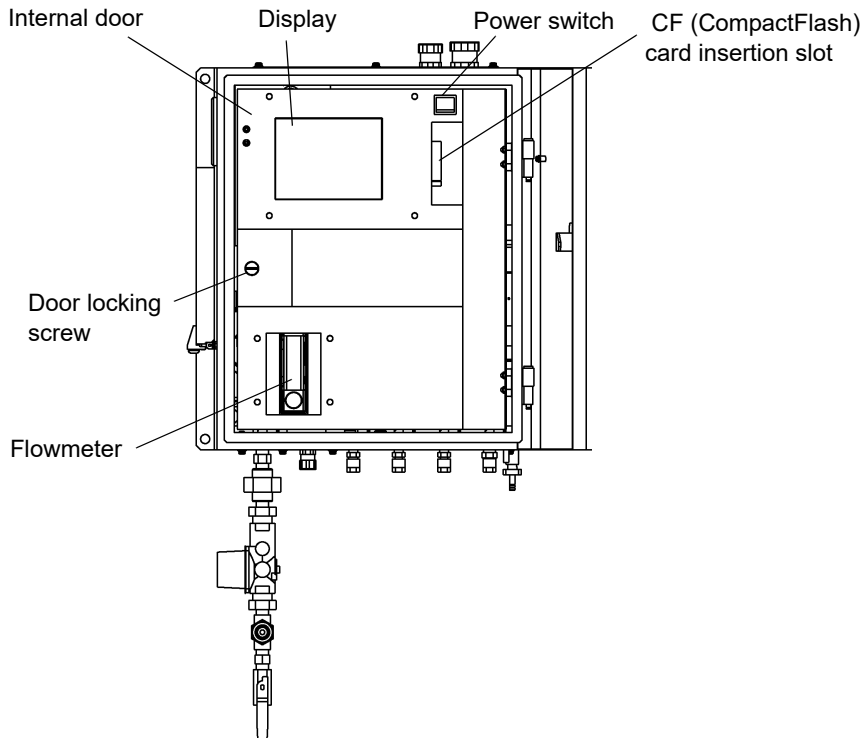

● **Bottom - side connectors**

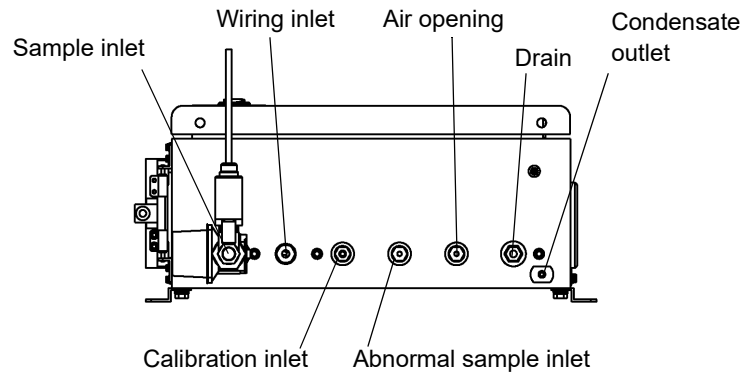

1.2.2 Display

This section explains the contents of the display, using a typical screen as an example.

- The screen is equipped with a touch panel. Do not operate touch panel with wet finger or solid tools, such as pen or driver.
- The measurement items pH, conductivity and water temperature are optional and not included in the standard configuration.
- If the touch panel is not operated for a certain amount of time, the backlight is turned OFF.
- If not in the MEASUREMENT, DATA or ALARM screens, the display returns to the measurement screen after about two hours of inactivity.

● **Screen example - Displaying the values of measured items**

This screen displays the values for each measured item.

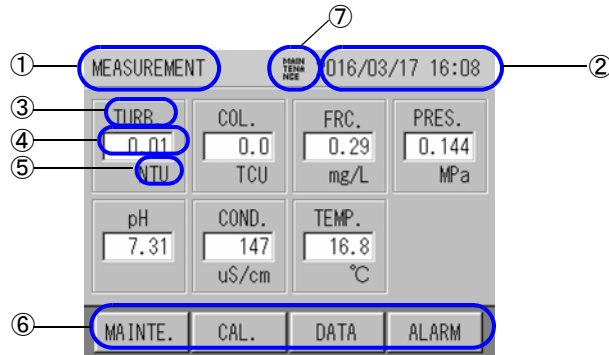

No.	Contents	Examples	
①	Screen title	MEASUREMENT, SPAN CAL..., DATA HISTORY	
②	Clock display	2004/01/30 09:57	
③	Measurement item	TURB., COL., FRC.	
④	Measurement value	-	
⑤	Unit	NTU, TCU, mg/L, etc.	
⑥	Operation buttons	MAINTE., CAL., etc.	
⑦	System status	WARM UP!	<ul style="list-style-type: none"> • The device is warming up The device is always warmed up when the power is turned on. The alarm display is cleared when the temperature of the turbidity/color cell becomes stable.
		Seq.	<ul style="list-style-type: none"> • Action operation The device is performing automatic calibration, automatic cleaning and alarm check setting, or the operations are finished and output is on hold .
		MAINTENANCE	<ul style="list-style-type: none"> • Maintenance mode The device is in maintenance mode. See"3.4 Maintenance Mode" (page 15).

● Screen example- Menu items are displayed

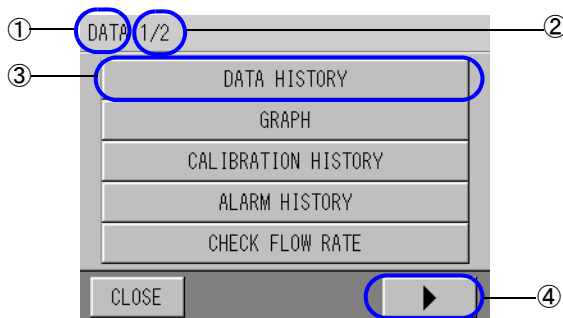

No.	Contents	Examples
①	Screen title	DATA, I/O SETTING, etc.
②	Screen page number	1/2, 2/2, etc.
③	Menu item	DATA HISTORY, GRAPH, etc.
④	Next page	-

● Screen example- History and Information confirmation display

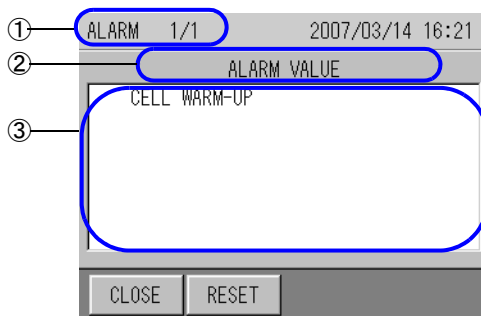

No.	Contents	Examples
①	Screen title	ALARM HISTORY, TEMPERATURE, etc.
②	Contents heading	ALARM, etc.
③	Data list	-

2 PREPARATION

The following preparations are required before operating the device. See Installation Manual for installation, piping and wiring instructions.

- pH sensor installation: For measuring pH
- Conductivity sensor installation: For measuring conductivity (optional)
- Beads insertion: For cleaning the residual-chlorine sensor

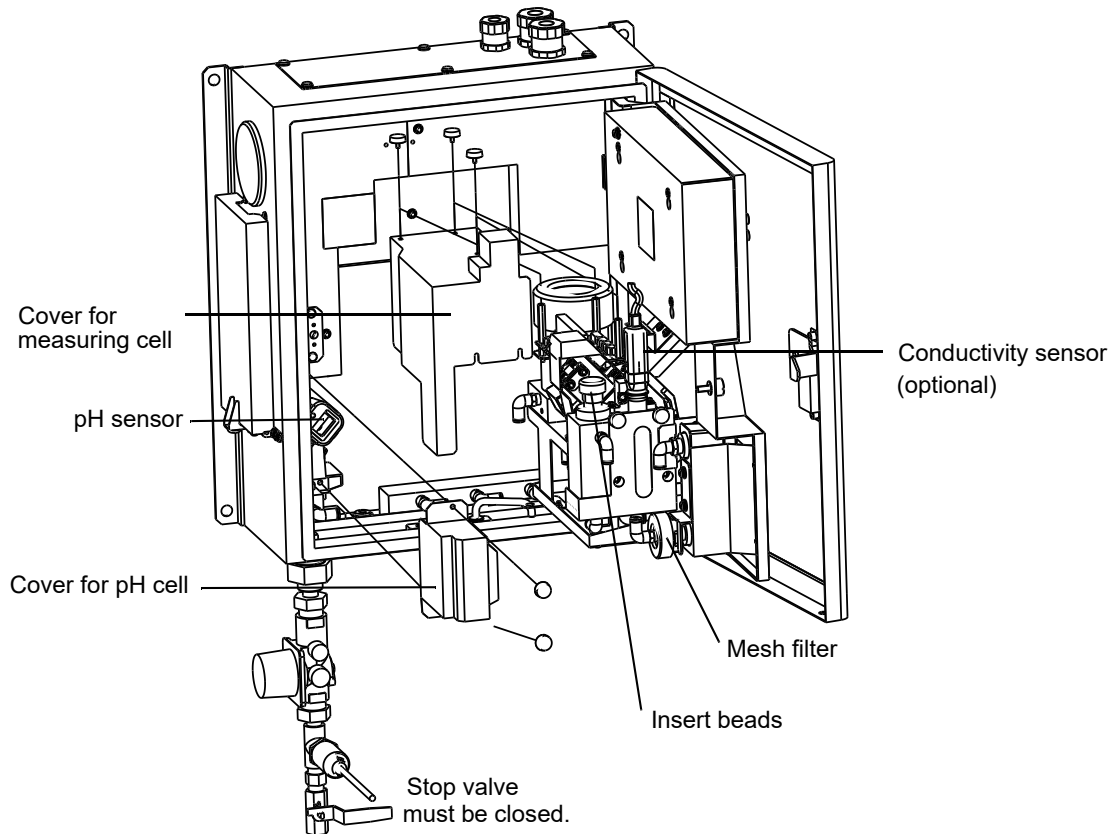

● Status of parts at delivery

Parts	Status on Delivery
Mesh filter	Installation required
Zero water filter	Installation required
Residual-chlorine sensor	Installed
Conductivity sensor	Installation required
pH sensor	Installation required

2.1 Opening the Inner Door of the Device

1. Push the bottom of the locking handle, and open the door while holding the handle.

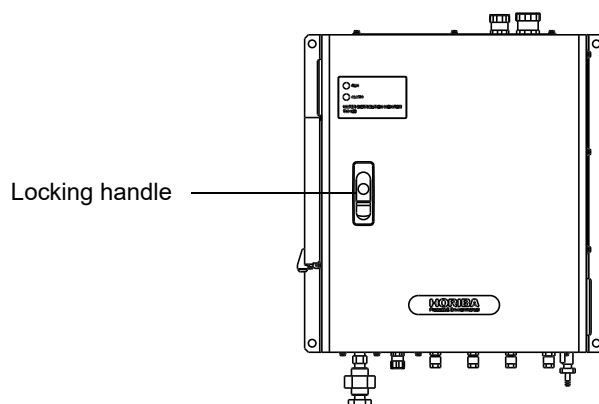

2. Make sure that the stop valve is closed and the power is OFF.
3. Turn and remove the door-locking screw and open the inner door.

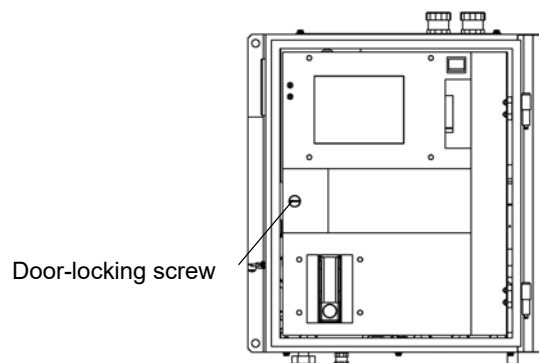

4. Attach the fixing bracket to the inside of the door to hold the door in place.

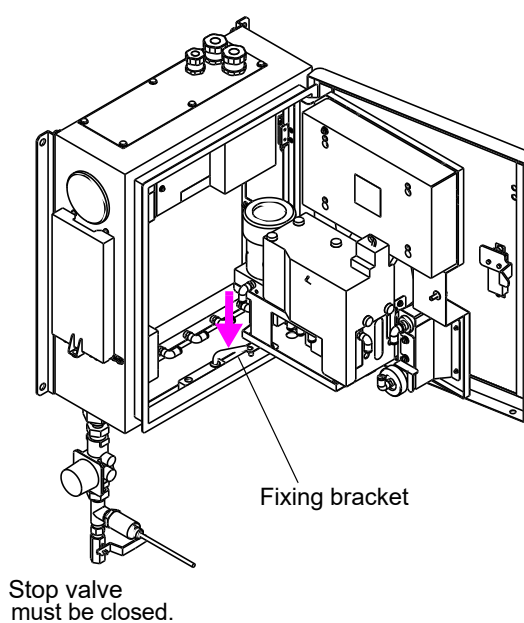

To close the door, reverse the procedure.

2.2 Installing the pH Sensor

1. Make sure that the stop valve is closed and the power is OFF.
2. Remove the protective cap, liquid-junction washer, rubber cap and connector cap from the pH sensor.

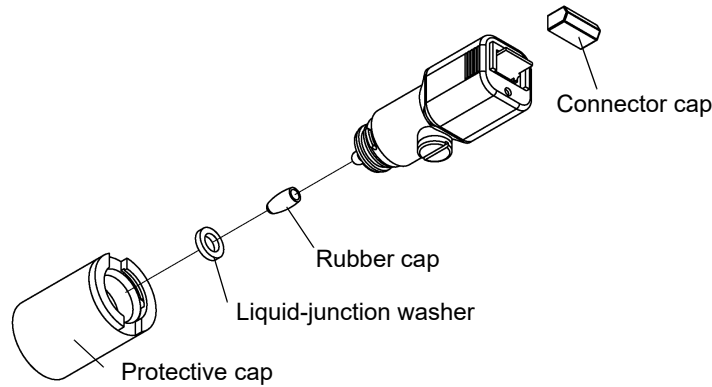

3. Push the brown protrusion on the side of the sensor into the pH cell, as shown in the following figure, and turn the sensor to the left.

Note

- The pH sensor top is made of glass. Take care not to break it when pushing the sensor in.
- Be careful not to loose the protective cap, liquid junction washer, rubber cap and connector cap as they are used to store the sensor.

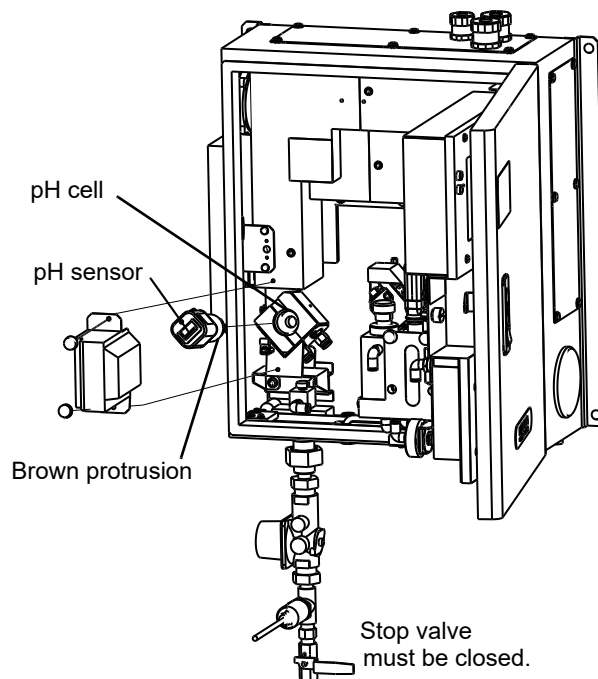

4. Connect the pH sensor to the connector.

Reference

"7.3 Connection Locations for the Sensor Connectors" (page 138)

2.3 Installing the Conductivity Sensor (optional)

1. Make sure that the stop valve is closed and the power is OFF.
2. Loosen the screws and remove the cover.

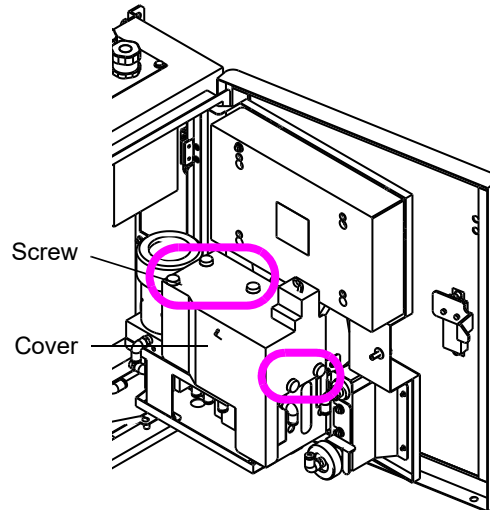

3. Remove the cap from the conductivity sensor.

Note

Be careful not to lose the protective cap, as it will be used to store the sensor.

4. Install the conductivity sensor to the electric conductivity sensor's installation position in the residual-chlorine/conductivity cell.

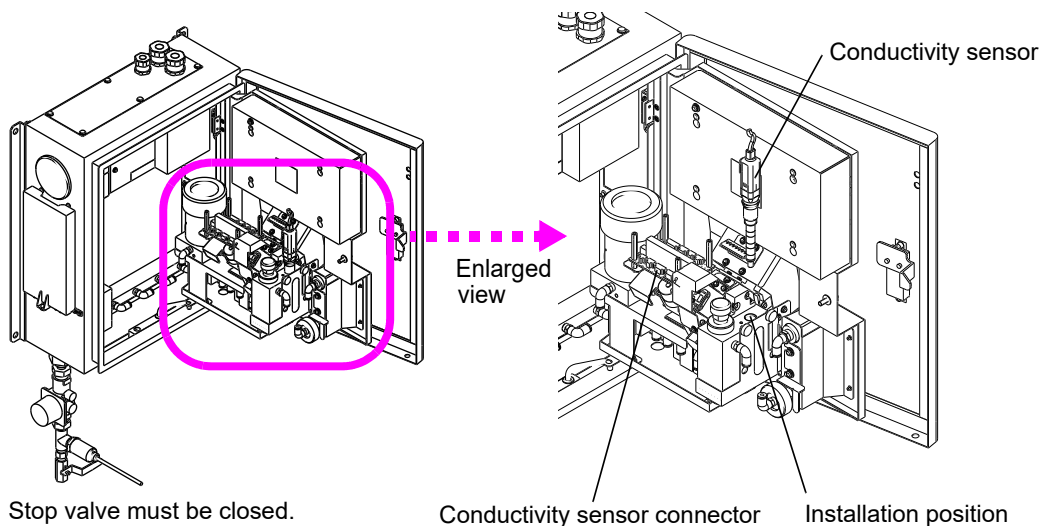

5. Connect the sensor connector.
6. Attach the cover and tighten the screws.

2.4 Insert Beads

1. Make sure that the stop valve is closed and the power is OFF.
2. Loosen the screws and remove the cover.

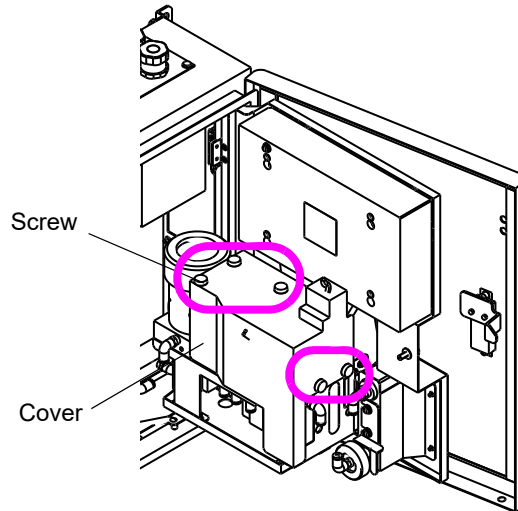

3. Remove the sensor connector.

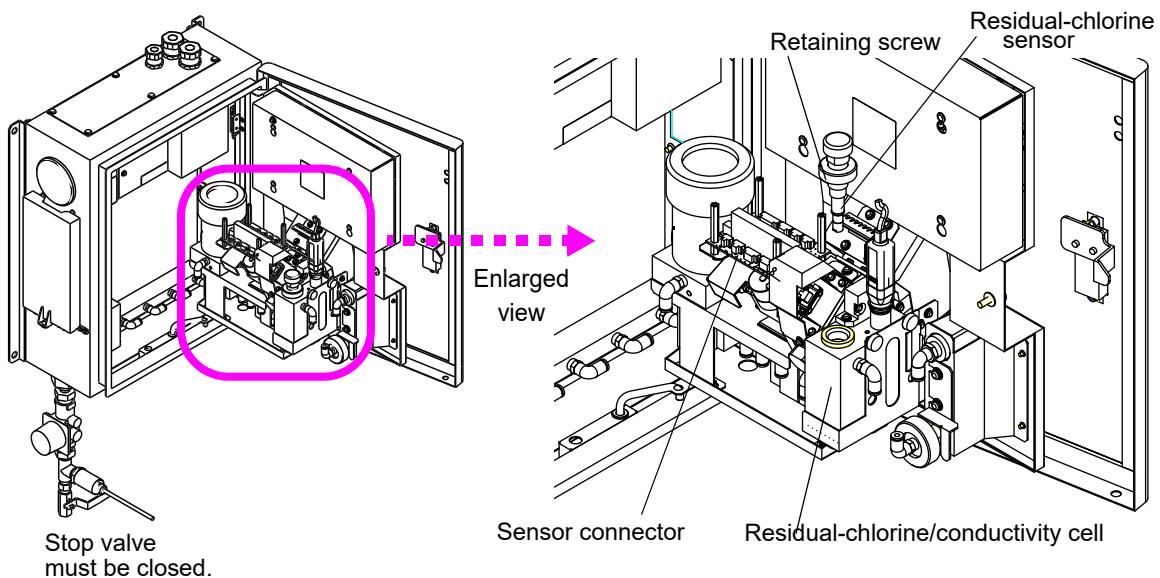

4. Loosen the sensor retaining screw and remove the residual-chlorine sensor.
5. Insert a set of beads into the residual-chlorine sensor's installation position in the residual-chlorine/conductivity cell.

Note

All beads in the case is necessary to be installed in residual-chlorine cell. Number of beads may affect polishing the electrode and sensitivity.

6. Insert the residual-chlorine sensor into the residual-chlorine/conductivity cell and tighten the retaining screw to prevent it from moving.
7. Connect the sensor connector.
8. Attach the cover and tighten the screws.

3 OPERATION

3.1 Starting the Device

1. Make sure that the device is correctly installed, according to the instructions in the Installation Manual.
2. Open the stop valve.
A sample water will start to flow into the unit.

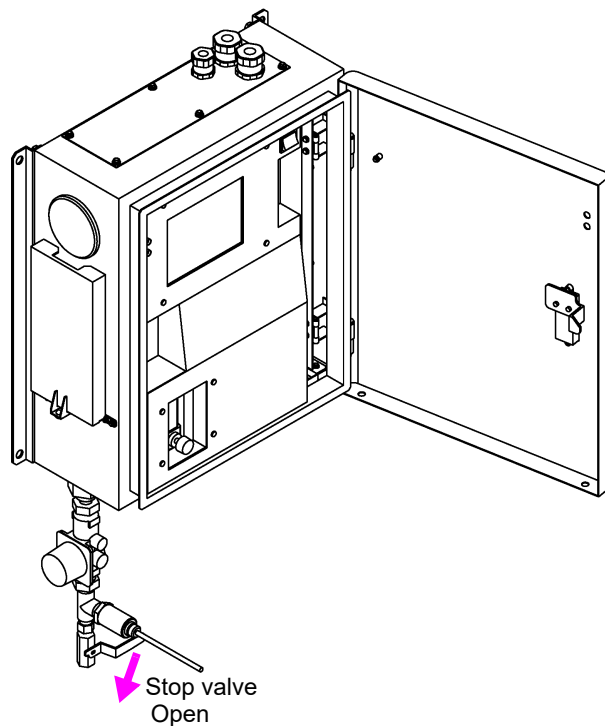

3. Adjust the flow rate to 80 mL/min using the flowmeter valve.

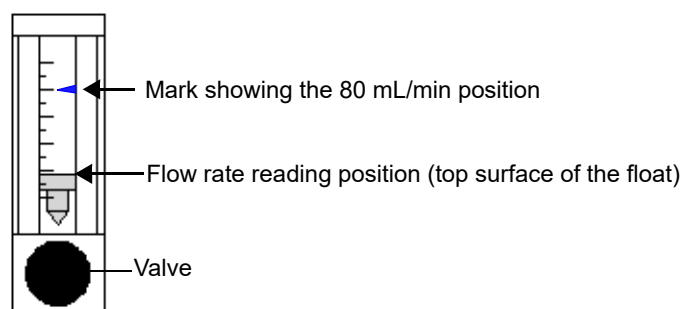

4. Open the inner door and make sure that there is no leaking.

5. Turn ON the power.

Wait a while until the screen turns displays the MEASUREMENT screen.

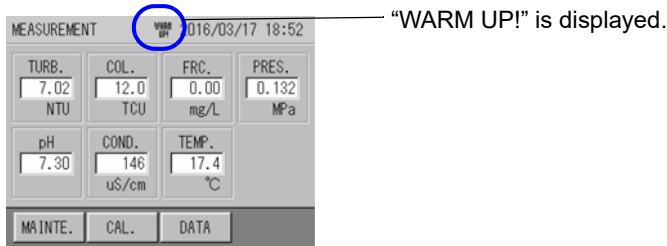

“WARM UP!” is displayed until the temperature of the turbidity/color cell becomes stable (approximately 20 minutes).

6. Adjust the clock.

Reference

"5.7 Clock Adjustment" (page 94)

7. Change the settings as needed.

Reference

"5 FUNCTION" (page 75)

8. Calibrate the values.

Note

When starting the device or after replacing a sensor, operate the device for at least two hours using sample water until the sensor becomes stable, then perform calibration.

Reference

"4 CALIBRATION" (page 17)

When the start-up procedure is complete, measurement begins.

3.2 Stopping the Device

3.2.1 When stopping the device for a week or less

1. Turn off the power.
2. Close the stop valve.

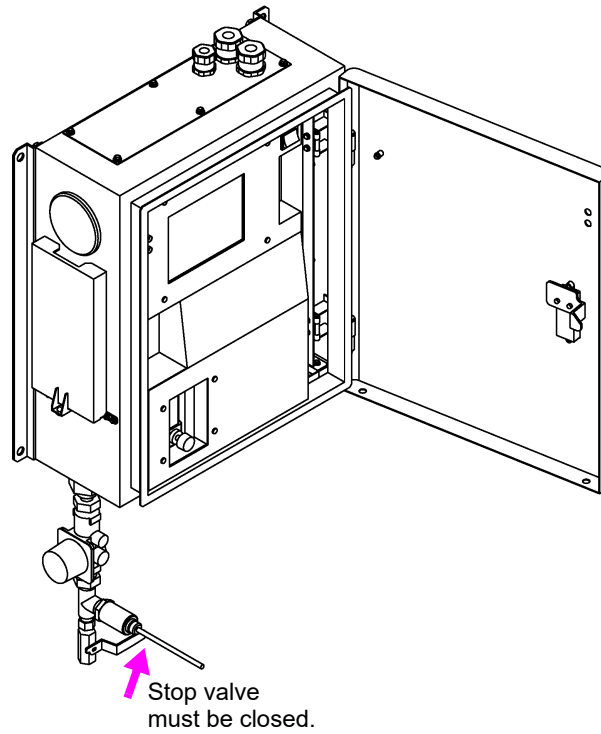

3.2.2 When stopping the device for a week or more

1. Close the stop valve.
2. Start the water discharge operation action.

Reference

"5.11 Action" (page 105)

3. Turn the power OFF.
4. Open the inner door of the device.

Reference

"2.1 Opening the Inner Door of the Device" (page 7)

5. Make sure that a sample water is flowing out from the residual-chlorine/ conductivity cell (conductivity is optional).

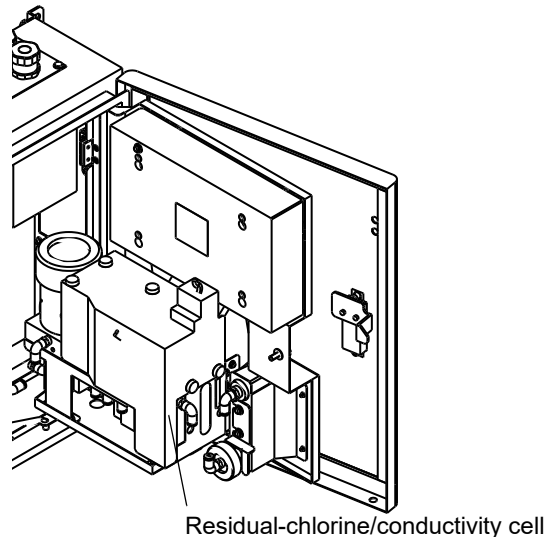

Tip

If water does not discharge properly, run sample water again and repeat the procedure from step 1.

6. Remove the residual-chlorine sensor and the sample water and beads inside the cell using the provided syringe, and then install the residual-chlorine sensor again.

Reference

"7.4.3 Maintenance of the residual-chlorine sensor" (page 142)

7. Remove the pH and conductivity (optional) sensors and cover the cell with a cloth to keep it free of dust.

Reference

- "7.4.4 Replacing and storing the conductivity sensor (optional unit)" (page 144)
 - "7.4.5 Replacing and storing the pH sensor" (page 145)
-

8. Close the inner door and door of the device.

3.3 Restarting the Device

3.3.1 When stopping the device for a week or less

Follow the procedure in "3.1 Starting the Device" (page 11).

3.3.2 When stopping the device for a week or more

1. Remove the residual-chlorine sensor, insert beads, and then reinstall the sensor.

Reference

"7.4.3 Maintenance of the residual-chlorine sensor" (page 142)

2. Install the pH and conductivity sensors.

Reference

- "2.2 Installing the pH Sensor" (page 8)
 - "2.3 Installing the Conductivity Sensor (optional)" (page 9)
-

3. Follow the procedure in "3.1 Starting the Device" (page 11).

3.4 Maintenance Mode

When it is necessary to perform maintenance, you can hold outputs by switching to maintenance mode.

- To enter maintenance mode, press [MAINTENANCE] or [CAL.] on the MEASUREMENT screen and go to the MAINTENANCE or CALIBRATION screen.
- The screen returns to the MEASUREMENT screen and continues in maintenance mode for one minute, and then "MAINTENANCE" is displayed at the top of the screen.

Reference

See "5.2.2 Setting external output during operation" (page 79) for maintenance operations.

3.5 Precautions for Measurements

- **Switch to maintenance mode when opening the inner door.**

Opening the inner door during measuring affects the values of turbidity and color measurements. Do the following to avoid abnormal output or alarms.

- Press [MAINTENANCE] or [CAL.] and enter maintenance mode.
- Set maintenance-mode output to PRESET or HOLD.

Reference

"5.2.2 Setting external output during operation" (page 79)

- **Install the device so that backpressure is not created in the cells**

Backpressure in the cells may severely shorten the operational life of the pH sensor.

Backpressure is created if the drain pipe is located above the device, or if the drain clogs.

- **Clean the sensors and cells when they get dirty**

If abnormal sample water is run through the device, the sensors and cells may get dirty. Cleaning is required if dirt can be seen on the sensor. Contact a service representative.

- **Run sample water and wait until the measured values become stable**

- The measured values may be unstable for a while after sensor installation.
- The measured values may be unstable for a few hours after running color calibration solution (chloroplatinic acid) through the device.

- **Adjust the flow rate of sample water to 80 mL/min**

The sample water flow rate affects measurement of the residual chlorine.

- **A dry flowmeter takes approximately two weeks to become stable**

When using the device for the first time, or after stopping it for more than a week, it takes approximately two weeks until the flowmeter becomes stable after running water through the device. You are required to readjust the flow rate after the flowmeter becomes stable.

- **Replace the mesh filter periodically**

Foreign particles in sample water can get clogged in the mesh filter and cause reduction of the flow rate. The mesh filter should be replaced every three months; however, earlier replacement may be required depending on the condition of the sample water.

4 CALIBRATION

Calibration is to adjust and match the measured and actual values and required to maintain accurate measurement and system performance.

4.1 Calibration Patterns and Cycles

Periodic calibration is required.

Calibrate the values using any of the following patterns.

● Std. item

⊙ Recommended calibration ○ Simple calibration

Measurement item	Calibration pattern	Calibration cycles				Procedure reference
		System startup	Daily	Every 3 months	Abnormality occurrence	
pH	Zero calibration and span calibration	⊙	–	⊙	⊙	page 24
	Adjustment calibration using sample water (Zero calibration)	○	–	○	○	page 29
Turbidity/color/residual chlorine	Automatic zero-calibration	–	⊙	–	–	page 82
Turbidity	Common zero-calibration and span calibration	⊙	–	⊙	⊙	page 64
	Individual zero calibration and span calibration	○	–	○	○	page 48
	Adjustment calibration using sample water (Zero calibration)	○	–	○	○	page 62
Color	Common zero-calibration and span calibration	⊙	–	⊙	⊙	page 32
	Individual zero-calibration and span calibration	○	–	○	○	page 37
	Adjustment calibration using sample water (Zero calibration)	○	–	○	○	page 40
Residual chlorine	Common zero-calibration and span calibration	○	–	○	○	page 64
	Individual zero-calibration and span calibration	○	–	○	○	page 68
	Adjustment calibration using sample water (Span calibration)	⊙	–	⊙	⊙	page 62
Water pressure	Adjustment calibration using sample water (Zero calibration)	–	–	–	– (Check only)	page 71

● Optional item

Measurement item	Calibration pattern	Calibration cycles				Procedure reference
		System startup	Daily	Every 3 months	Abnormality occurrence	
Conductivity	Span calibration	◎	–	◎	◎	page 54
	Individual zero-calibration	–	–	–	◎	
	Adjustment calibration using sample water (Span calibration)	○	–	○	○	page 60
Water temperature	Adjustment calibration using sample water (Zero calibration)	–	–	–	– (Check only)	page 73

- Perform calibration at system startup and every three months in the following order: Common zero-calibration → pH → color → turbidity → conductivity (optional) → residual chlorine.
- Replace the mesh filter after a three-month calibration.
- Water pressure and water temperature (optional) are already calibrated before shipment, so additional calibration is unnecessary. The calibration procedure is given as a reference. Only when an abnormality occurs, check that the calibration value is close to the manually-analyzed value.
- Adjustment calibration of pH using sample water is recommended every month.

● Calibration information

Calibration	Target	Flow rate	Description
Individual zero-calibration	<ul style="list-style-type: none"> ● Turbidity ● Color ● Conductivity ● pH 	50 mL/min	It is normal zero calibration performed manually using zero calibration solution for each measurement item. Keep zero calibration solution in the calibration tank. Using button operation, switch the liquid from the sample water to zero calibration solution and start calibration.
	<ul style="list-style-type: none"> ● Residual chlorine 	80 mL/min	
Common zero-calibration	<ul style="list-style-type: none"> ● Turbidity ● Color ● Residual chlorine 	80 mL/min	It is performed manually using common zero calibration solution for the three items: turbidity, color and residual chlorine. Filtering sample water using the filter inside the device generates zero calibration solution. Button operation for starting calibration switches the sample water flow from the normal measurement line to the filter line and starts calibration. This operation does not use the calibration tank.
Automatic zero calibration	<ul style="list-style-type: none"> ● Turbidity ● Color ● Residual chlorine 	80 mL/min	It is performed automatically using common zero calibration solution for the three items: turbidity, color and residual chlorine. Filtering sample water using the filter inside the device generates zero calibration solution. Button operation for starting calibration switches the sample water flow from the normal measurement line to the filter line and starts calibration. The calibration solution tank is unused as well as common zero calibration. You are required to set the first calibration date and time and interval between calibrations.
Span calibration	<ul style="list-style-type: none"> ● Turbidity ● Color ● Residual chlorine ● pH 	50 mL/min	It is general span calibration performed manually using span calibration solution for each measurement item. Keep span calibration solution in the calibration tank. Button operation for starting calibration switches the liquid from the sample water to span calibration solution and starts calibration.
	Residual chlorine	80 mL/min	
Adjustment calibration using sample water	<ul style="list-style-type: none"> ● Turbidity (zero calibration) ● Color (zero calibration) ● Residual chlorine (span calibration) ● Water pressure (zero calibration) ● pH (zero calibration) ● Electric conductivity (span calibration) ● Water temperature (zero calibration) 	80 mL/min	It is performed to adjust the value measured by the device to match the value analyzed manually or measured using another instrument using running sample water (tap water). Performed manually. Calibration solution and the calibration tank are not used.

● Calibration coefficient

Calibration coefficient	Contents
Zero calibration coefficient	Represents variation of the zero point.
Span calibration coefficient	Represents the inclination in response to sensitivity.

	Zero calibration coefficient				Span calibration coefficient			
	Min.	Ref. value	Max.	Unit	Min.	Ref. value	Max.	Definition
Turbidity	-2.000	0.000	2.000	Light absorption calculated by value of electric current	20.000	50.000	100.000	Light absorption → Conversion coefficient of turbidity
Color	-2.000	0.000	2.000	Light absorption calculated by value of electric current.	30.000	58.000	100.000	Light absorption → Conversion coefficient of color
Residual chlorine	-800.000	0.000	800.000	nA	0.300	1.000	5.000	Sensitivity
Water pressure	-0.200	0.000	0.200	MPa	0.800	1.000	1.200	Sensitivity
pH	-89.000	0.000	89.000	mV (pH asymmetric potential)	0.800	1.000	1.200	Sensitivity
Conductivity	-500.000	0.000	500.000	mV	0.500	1.000	1.500	Sensitivity
Water temperature	-10.000	0.000	10.000	°C	0.800	1.000	1.200	Sensitivity

4.2 Precautions for Calibration

● Follow the correct order for calibration

Perform calibration in the following order. Common zero calibration → pH → color → turbidity → conductivity (optional) → residual chlorine.

Calibrating pH after color may cause measurement unstableness and calibration failure.

● Remove the residual-chlorine sensor before performing span calibration for color.

When performing span calibration for color, remove the residual-chlorine sensor and attach the provided rubber plug. Span calibration solution for color affects the residual-chlorine sensor.

● Adjustment calibration using sample water

The relevant calibration coefficient for each measurement item may be a zero-calibration coefficient or span-calibration coefficient depending on the item. After calibration, the target calibration value is updated and the previous result is kept for the other calibration value.

Measurement items	Target calibration value	Remarks
Turbidity	Zero calibration value	When automatic zero calibration is set, the zero calibration coefficient is updated if automatic zero calibration is executed.
Color	Zero calibration value	
Residual chlorine	Span calibration value	–
Water pressure	Zero calibration value	–
pH	Zero calibration value	–
Conductivity	Span calibration value	–
Water temperature	Zero calibration value	–

● Calibration alarms

If a calibration value goes beyond a specified range, an alarm occurs and calibration is not updated. The previous calibration value continues to be used.

● Tips for flow rate adjustment

- Quickly adjust the flow rate after calibration. If flow rate adjustment is delayed, calibration solution in the calibration tank may dry up during calibration.
- The flow rate changes when running calibration solution at calibration starting from when running sample water after calibration. Flow rate adjustment is required for each time.
- In calibration using the calibration tank, if there are air bubbles in the pipe causing poor flow of calibration solution, fully open the valve and raise the calibration tank to smooth the flow. After confirming that the flow is stable, make sure to adjust the flow rate.

● Do not touch calibration solution.

When disconnecting the calibration tank from the calibration inlet after calibration, wear protective equipment, such as gloves to avoid direct contact with the solution.

● Dispose of used fluid according to local laws.

After calibration, obtain used fluid, such as span calibration solution including the fluid remaining in the pipe in the used fluid tank and dispose of it according to the appropriate laws, such as the sewerage law.

pH 9 calibration solution is alkaline and color calibration solution (chloroplatinic acid) contains cobalt heavy metal and is strongly acidic. Special care is required for proper disposal.

● **Tips for improving calibration accuracy**

- Adjust the temperature of the calibrating solution to that of the sample water.
- Perform span calibration close to the upper limit of the measurement range.
Use span calibration solution whose value stays within the range.
- When starting the system or after replacing the sensors, test run the device for more than two hours before starting calibration.

4.3 Displaying the Calibration Screen

1. Press [CAL.] on the MEASUREMENT (main) screen.

The CALIBRATION screen is displayed, displaying the calibration menu.

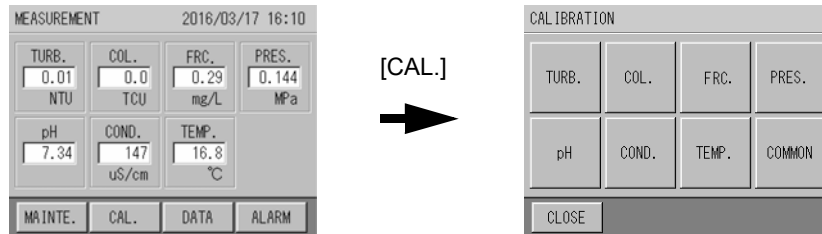

2. Press the button of the item to be calibrated.

The calibration screen for the selected item is displayed.

Example when the selected item is TURB.

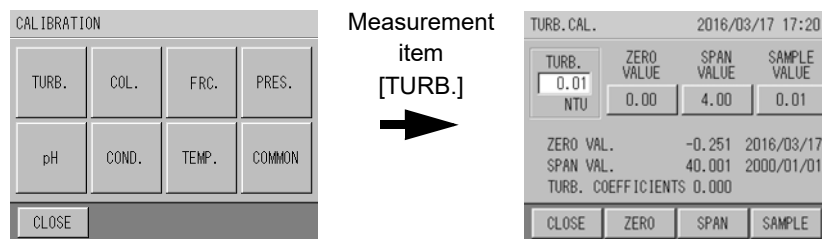

3. Perform calibration by following the calibration procedure.

4.4 Calibrating pH

pH is optional.

There are two calibration patterns for pH. See "4.1 Calibration Patterns and Cycles" (page 17) and select one of the patterns.

Every month calibration using sample water is recommended to measure accurate pH value.

4.4.1 Individual zero calibration and span calibration <pH>

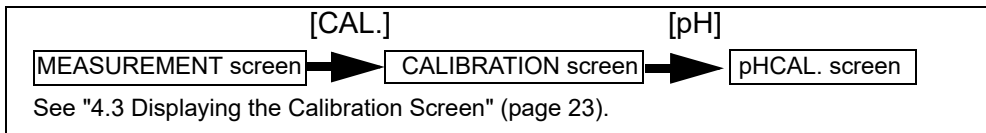

● Preparation

- Calibration tank...2
- Zero calibration solution...1 L (Pour the solution into one of the calibration tanks)
- Span calibration solution...1 L (Pour the solution into the other calibration tank)
- Used fluid tank (Install it so that used fluid flows into the tank)

● Calibration procedure

Calibrate in the order of Individual zero calibration → span calibration.

● Individual zero calibration

1. Place the calibration tank with zero calibration solution beside the device.
2. Connect the tank to the calibration inlet of the device.

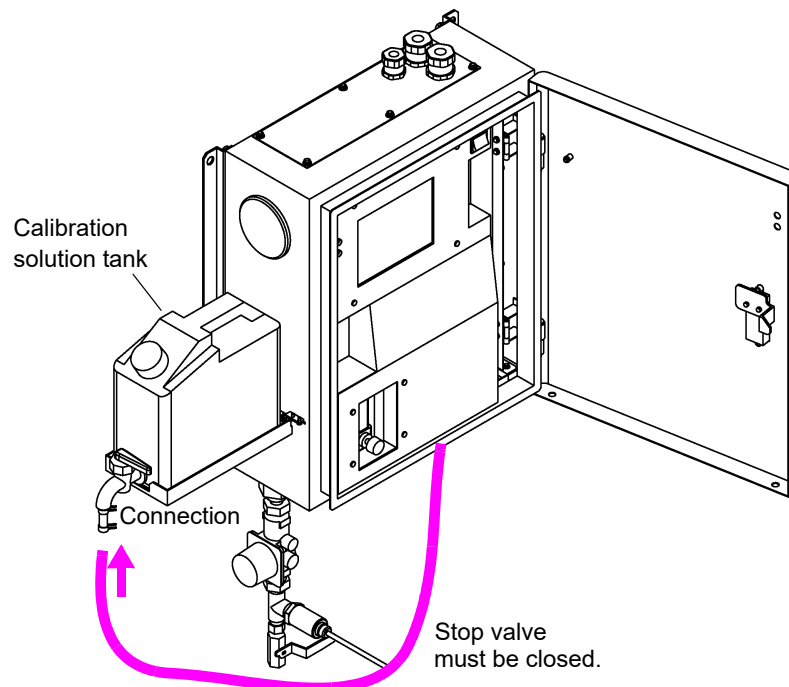

3. Press the ZERO VALUE button ([x.xx]) on the pHCAL. screen.
The zero calibration value input screen is displayed.

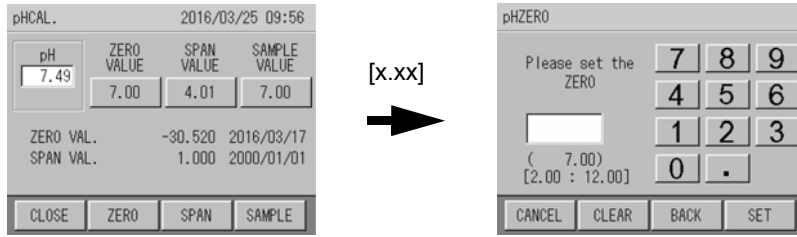

4. Enter the zero calibration value using the numerical key pad and press [SET].
Input range: pH 2.00 to pH 12.00

Tip

- [CLEAR]: Clears the whole value.
- [BACK]: Deletes the rightmost number of the value.

The screen returns to the pHCAL. screen.

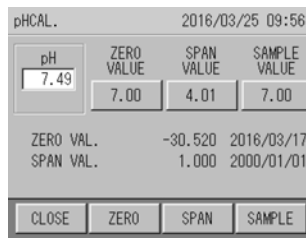

5. Open the valve of the calibration tank.
6. Press [ZERO].
A confirmation screen is displayed asking whether to start calibration.

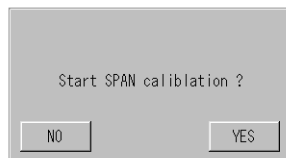

7. Press [YES] to start zero calibration.
The screen shows that the calibration is in progress.

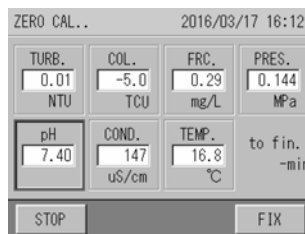

8. Adjust the flow rate to 50 mL/min using the flowmeter valve.

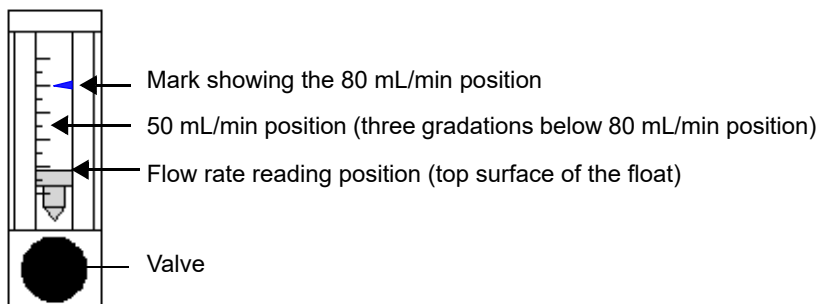

Wait until the calibration is completed (10 minutes).

Tip

[FIX]: Forcibly stops the calibration and updates it without waiting for automatic completion
[STOP]: Stops the calibration

The screen shows that the calibration is complete.

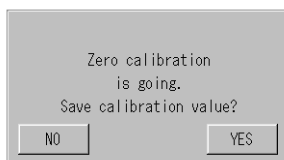

9. Press [YES].

The pH calibration coefficient is updated.

10. Close the valve of the calibration tank.

11. Disconnect the calibration tank from the calibration inlet of the device.

Note

Make sure if the measured value of sample water is stable after pH 6.86 calibration completed. Then start pH 9.18 calibration.

● Span calibration

1. Place the calibration tank with Span calibration solution beside the device.
2. Connect the tank to the calibration inlet of the device.
3. Press the **SPAN VALUE** button ([x.xx]) on the pHCAL. screen.

The span calibration value input screen is displayed.

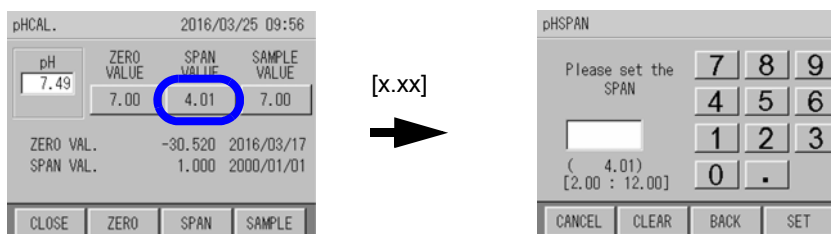

4. Enter the span calibration value using the numerical key pad and press **[SET]**.

Input range: pH 2.00 to pH 12.00

Tip

[CLEAR]: Clears the whole value.

[BACK]: Deletes the rightmost number of the value.

The screen returns to the pHCAL. screen.

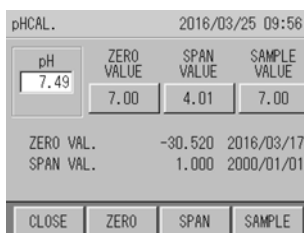

5. Open the valve of the calibration tank.
6. Press **[SPAN]**.

A confirmation screen is displayed asking whether to start calibration.

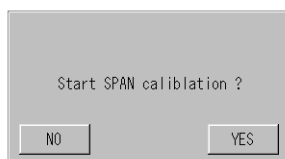

7. Press **[YES]** to start span calibration.

The screen shows that the calibration is in progress.

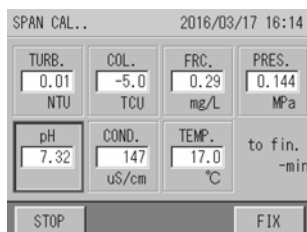

8. Adjust the flow rate to 50 mL/min using the valve.

Wait until the calibration is completed (10 minutes).

— Tip —

[FIX]: Forcibly stops the calibration and updates it without waiting for automatic completion

[STOP]: Stops the calibration

The screen shows that the calibration is complete.

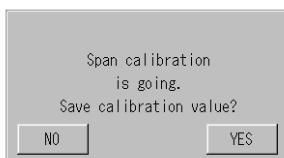

9. Press [YES].

The pH span calibration coefficient is updated.

10. Close the valve of the calibration tank.

11. Open the stop valve.

12. Adjust the flow rate of the sample water to 80 mL/min using the valve.

13. Disconnect the calibration tank from the calibration inlet of the device.

4.4.2 Adjustment calibration using sample water <pH>

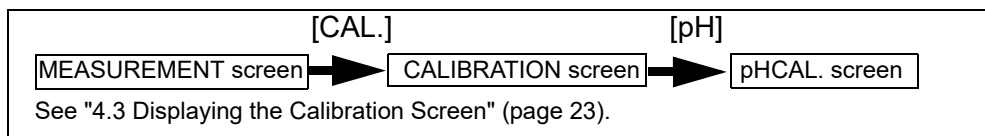

● Preparation

- pH meter...1

● Calibration procedure

1. Adjust the flow rate of the sample water to 80 mL/min using the valve.
2. Measure pH of the prepared sample water using a pH meter other than this device's, and calculate the value.
3. Press the **SAMPLE VALUE** button ([x.xx]) on the pHCAL. screen.
The sample water calibration value input screen is displayed.

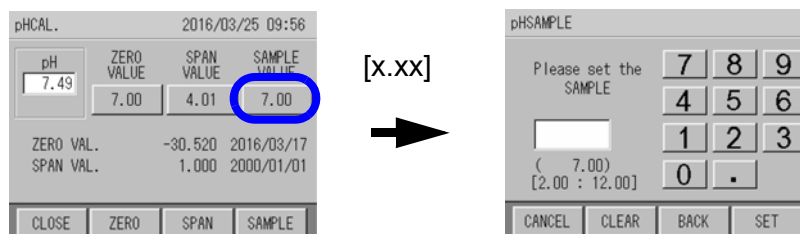

4. Enter the measured value of the sample water using the numerical key pad and press **[SET]**.
Input range: 2.00 to 12.00

Tip

[CLEAR]: Clears the whole value.

[BACK]: Deletes the rightmost number of the value.

The screen returns to the pHCAL. screen.

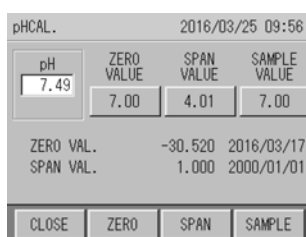

5. Press **[SAMPLE]**.

A confirmation screen is displayed asking whether to start calibration.

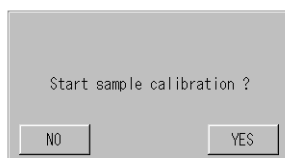

6. Press [YES] to start sample water calibration.

The screen shows that the calibration is in progress.
Wait until the calibration is completed.

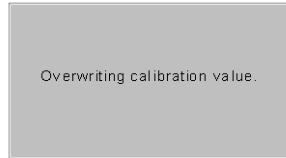

The screen shows that the calibration is complete.

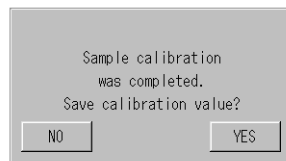

7. Press [YES].

The pH zero calibration coefficient is updated.

4.5 Calibrating Color

There are three calibration patterns for color, not including automatic zero calibration. See "4.1 Calibration Patterns and Cycles" (page 17) and select one of the patterns. See "5.3 Automatic Zero Calibration" (page 82) for automatic zero calibration settings.

Note

Span calibration solution for color affects the residual-chlorine sensor. When performing span calibration for color, remove the residual-chlorine sensor and attach the provided rubber plug.

Tip

Turbidity may cause variation in the measured value of color. Correct turbidity as required. See "5.10.3 Correcting color using turbidity" (page 102).

● <Reference> Making color span calibration solution



CAUTION



CHEMICAL CAUTION

Be careful not to drop color span calibration solution on your skin or drink it. If color span calibration solution comes into contact with your skin or eyes, immediately wash away with running water. If you swallow the solution, contact your doctor immediately.

● Color standard solution (500 PtCo)

Referring to ASTM D1209

Reagent	Amount
Kalium hexachloro-platinate (IV)	1.245 g
Cobalt (II) chloride hexahydrate	1.00 g
Hydrochloric acid	100 mL

Take 1.245 g kalium hexachloro-platinate (IV) (potassium chloroplatinate) and 1.00 g of cobalt (II) chloride hexahydrate, add them to 100 mL of hydrochloric acid. Dissolve it with purified water, pour it into a 1000 mL flask, and then fill it with purified water up to the gauge line. Store the liquid in a colored bottle.

● Color standard solution (20 PtCo)

Put 40 mL of commercial color standard solution (500 PtCo) or solution prepared using the above procedure into a 1000 mL flask and fill it with purified water up to the gauge line.

Note

This instrument is calibrated with the span calibration standard solution described above page 31 before sending for shipping inspection. Depending on the turbidity of the sample, measurement result may deviate from the TCU* manually analyzed value if default factory setting is used. Refer to page 166 for more information about the procedure for TCU unit conversion.

*: TCU (True Color Unit): "True chromaticity" which is obtained by measuring the chromaticity after filtration.

4.5.1 Common zero calibration and span calibration <color>

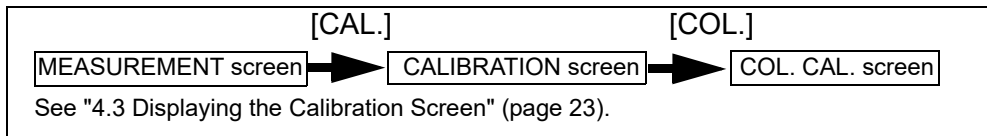

● Preparation

- Rubber plug (included)
- Calibration tank...1
- Span calibration solution...1 L (Pour the solution into the calibration tank)
- Used fluid tank (Install it so that used fluid goes into the tank)

Prepare span calibration solution according to the measurement range (0 TCU to 10 TCU or 0 TCU to 20 TCU).

— Tip —

Select 0 TCU to 10 TCU or 0 TCU to 20 TCU for the measuring range. See "5.10.2 Setting the range for turbidity and color" (page 101).

● Calibration procedure

Perform calibration in the order: common zero calibration → span calibration.

● Common zero calibration

Note

In common zero calibration, zero calibration is performed at the same time for the three measurement items: turbidity, color and residual chlorine. Therefore it is not necessary to perform zero calibration individually for turbidity, color and residual chlorine. In addition, you do not need to readjust the flow rate.

1. Press [COMMON] on the CALIBRATION screen.

A confirmation screen is displayed asking whether to start calibration.

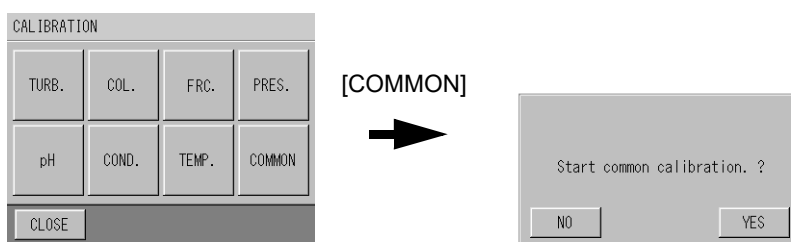

2. Press [YES] to start common calibration.

The COMMON ZERO CAL. screen is displayed.
Wait until the calibration is completed (10 minutes).

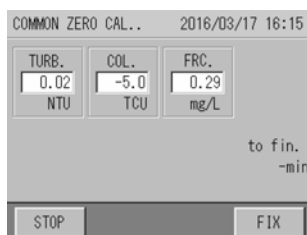

Tip

[FIX]: Forcibly stops the calibration and updates it without waiting for automatic completion
[STOP]: Stops the calibration

The RESULT screen is displayed.

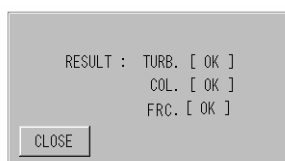

3. Press [CLOSE].

The zero calibration coefficients for turbidity, color and residual chlorine are updated.

● **Span calibration <color>**

● **Removing the residual-chlorine sensor**

1. Stop the device (close the stop valve, discharge water and turn OFF the power).

Reference

"● Stopping operation" (page 137).

2. Remove the residual-chlorine sensor.

Reference

"● Removing the residual-chlorine sensor" (page 142).

3. Attach the rubber plug to the residual chlorine/conductivity cell.
4. Close the inner door of the device and turn ON the power.

● **Calibration operation**

1. Place the calibration tank with span calibration solution beside the device.
2. Connect the tank to the calibration inlet of the device.

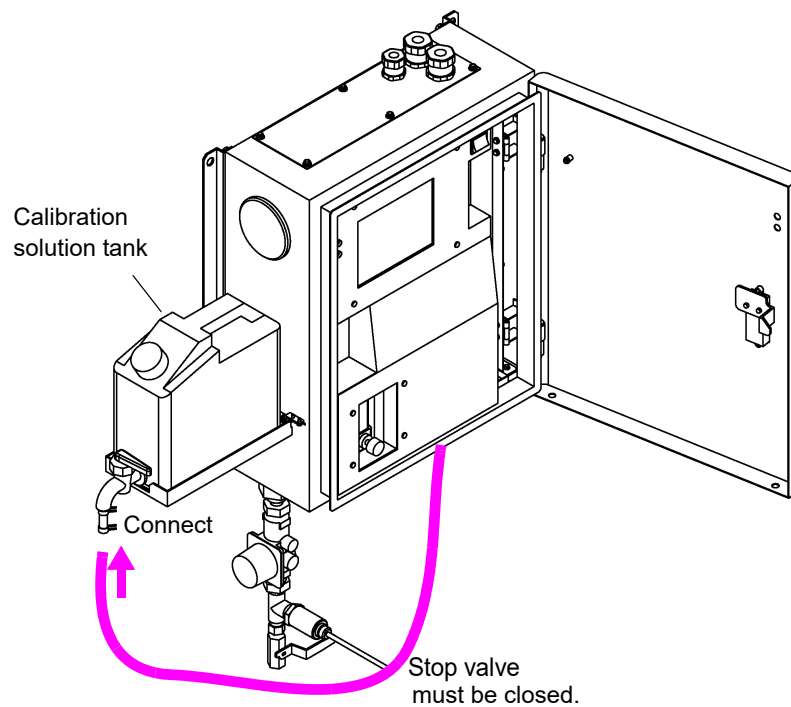

3. Confirm that "WARM UP!" is not displayed.

If displayed, wait until it disappears.

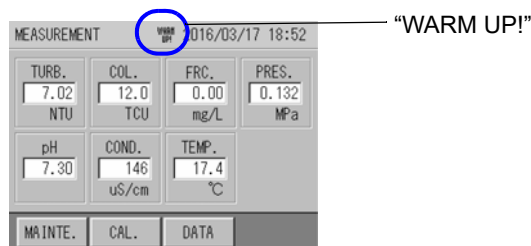

4. Press the **SPAN VALUE** button ([xx.x]) on the **COL. CAL.** screen.
The span calibration value input screen is displayed.

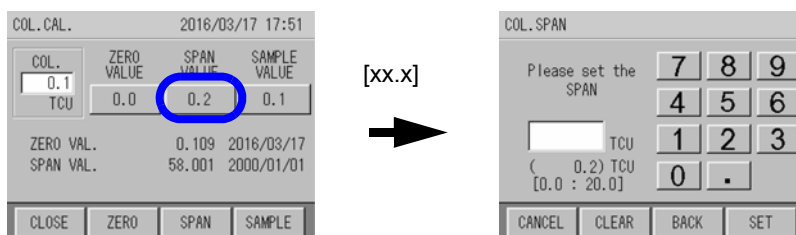

5. Enter the span calibration value using the numerical key pad and press **[SET]**.
Input range: 0.0 TCU to 20.0 TCU

Tip

- [CLEAR]**: Clears the whole value.
[BACK]: Deletes the rightmost number of the value.

The screen returns to the **COL. CAL.** screen.

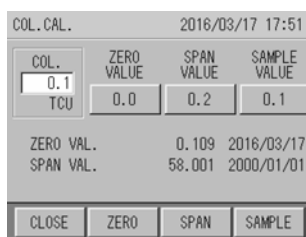

6. Open the valve of the calibration tank.
7. Press **[SPAN]**.
A confirmation screen is displayed asking whether to start calibration.

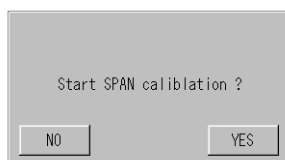

8. Press **[YES]** to start span calibration.
The screen shows that the calibration is in progress.

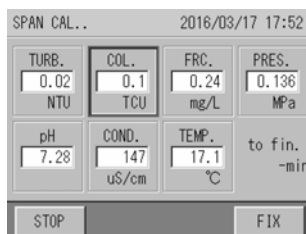

9. Adjust the flow rate to 50 mL/min using the valve.

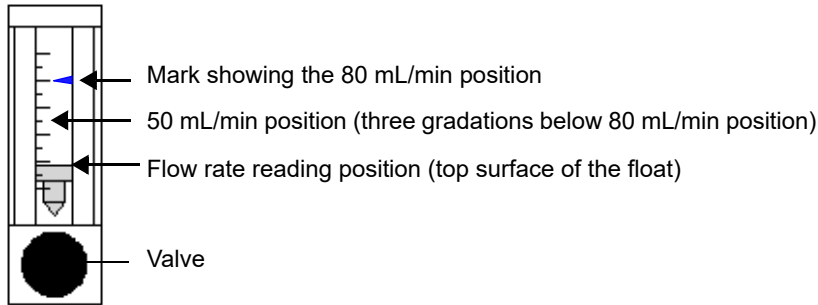

Wait until the calibration is completed (10 minutes).

Tip

[FIX]: Forcibly stops the calibration and updates it without waiting for automatic completion
[STOP]: Stops the calibration

The screen shows that the calibration is complete.

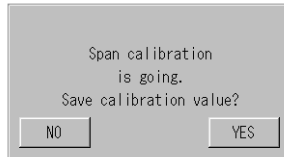

10. Press [YES].

The color span calibration coefficient is updated.

11. Close the valve of the calibration tank.

12. Disconnect the calibration tank from the calibration inlet of the device.

Note

Wear protective equipment, such as gloves to avoid direct contact with the solution.

● **Installing the residual-chlorine sensor**

1. Stop the device (close the stop valve, discharge water and turn OFF the power).

Reference

" ● Stopping operation" (page 137).

2. Remove the rubber plug.

3. Install the residual-chlorine sensor.

Reference

" ● Replacing beads" (page 143).

4. Open the stop valve.

5. Adjust the flow rate of the sample water to 80 mL/min using the valve.

6. Close the inner door of the device and turn ON the power.

Reference

" ● Restarting operation" (page 137).

4.5.2 Individual zero calibration and span calibration <color>

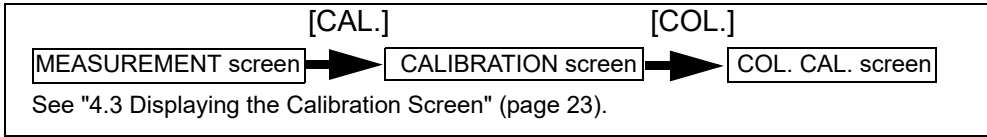

● **Preparation**

- Calibration tank...2
- Zero calibration solution...1 L (Pour the solution into one of the calibration tanks)
- Span calibration solution...1 L (Pour the solution into the other calibration tank)
- Used fluid tank (Install it so that used fluid goes into the tank)

● **Calibration procedure**

Perform calibration in the order: individual zero calibration → span calibration.

● **Individual zero calibration**

1. Place the calibration tank with zero liquid beside the device.
2. Connect the tank to the calibration inlet of the device.

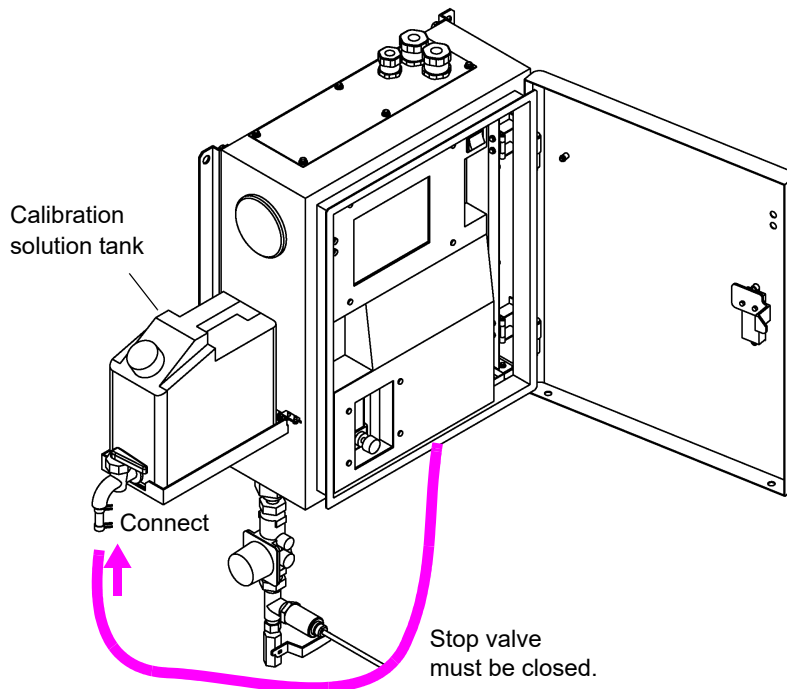

3. Press the ZERO VALUE button ([x.x]) on the COL. CAL. screen. The zero-calibration value input screen is displayed.

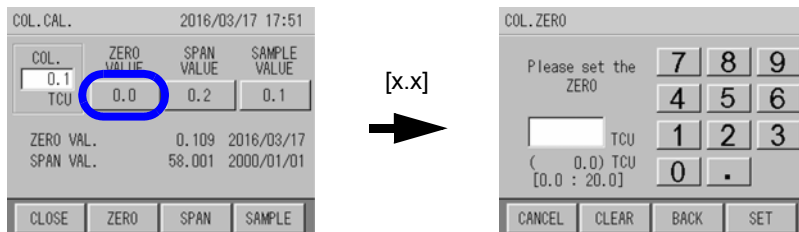

4. Enter the zero calibration value using the numerical key pad and press [SET].
 Input range: 0.0 TCU to 20.0 TCU

Tip

[CLEAR]: Clears the whole value.
 [BACK]: Deletes the rightmost number of the value.

The screen returns to the COL. CAL. screen.

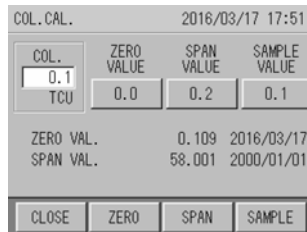

5. Open the valve of the calibration tank.
 6. Press [ZERO].
 A confirmation screen is displayed asking whether to start calibration.

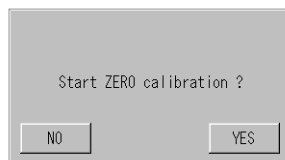

7. Press [YES] to start zero calibration.
 The screen shows that the calibration is in progress.

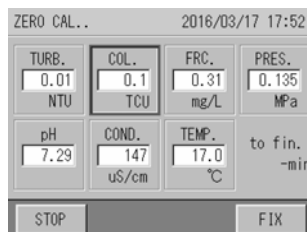

8. Adjust the flow rate to 50 mL/min using the flowmeter valve.

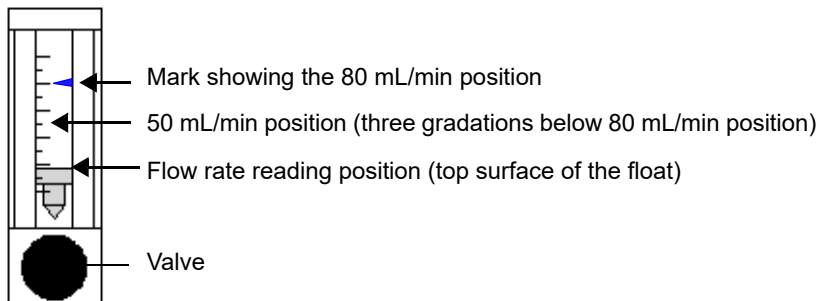

Wait until the calibration is completed (10 minutes).

Tip

[FIX]: Forcibly stops the calibration and updates it without waiting for automatic completion
 [STOP]: Stops the calibration

The screen shows that the calibration is complete.

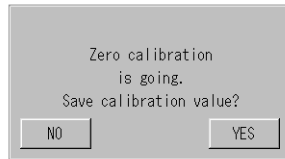

9. Press [YES].

The color zero calibration coefficient is updated.

10. Close the valve of the calibration tank.

11. Disconnect the calibration tank from the calibration inlet of the device.

● **Span calibration - color**

Follow the instructions given in " ● Span calibration <color>" (page 34).

4.5.3 Adjustment calibration using sample water <color>

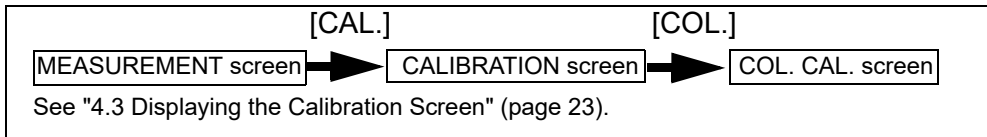

● **Preparation**

- Color meter..1

● **Calibration procedure**

1. Adjust the flow rate of the sample water to 80 mL/min using the valve.
2. Measure color of the prepared sample water using a color meter other than this device's and calculate the value.
3. Press the **SAMPLE VALUE** button ([x.x]) on the **COL. CAL.** screen.
The sample water calibration value input screen is displayed.

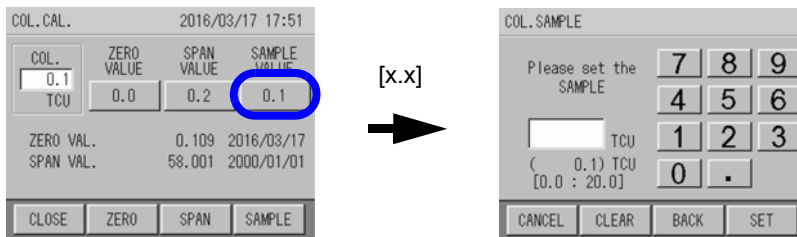

4. Enter the measured value of the sample water using the numerical key pad and press **[SET]**.

Input range: 0.0 TCU to 20.0 TCU

Tip

[CLEAR]: Clears the whole value.

[BACK]: Deletes the rightmost number of the value.

The screen returns to the **COL. CAL.** screen.

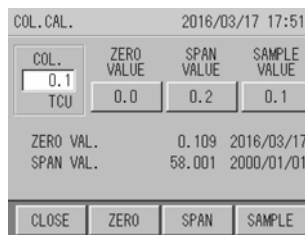

5. Press **[SAMPLE]**.

A confirmation screen is displayed asking whether to start calibration.

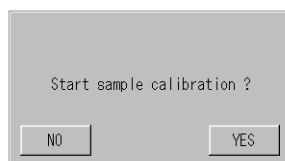

6. Press [YES] to start sample water calibration.

The screen shows that the calibration is in progress.
Wait until the calibration is completed.

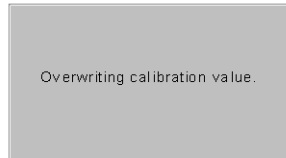

The screen shows that the calibration is complete.

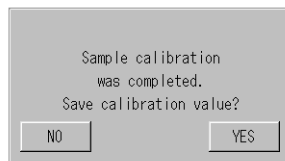
**7. Press [YES].**

The color zero calibration coefficient is updated.

4.6 Turbidity Calibration

There are three calibrating patterns for turbidity, not including automatic zero calibration. See "4.1 Calibration Patterns and Cycles" (page 17) and select one of the patterns. See "5.3 Automatic Zero Calibration" (page 82) for automatic zero calibration settings.

- **<Reference> Preparing the standard solutions (10 NTU)**

1. Weigh out 5.0 g of hydrazine sulfate (commercial special grade or above), and dissolve it in 400 mL of deionized water. Dissolve 50 g of hexamethylene tetramine (commercial special grade or above) in 400 mL of deionized water in another flask.
2. Mix the two solutions and add deionized water until the total solution volume is 1000 mL, and mix well. Store this solution at a temperature of 25°C ±3°C for 48 hours. The turbidity value (TURB) of this solution is equivalent to 4000 NTU.
3. Dilute 4000 NTU-solution 400 times (use a pipette to measure 2.5 mL of the 4000 NTU solution and pour it into a 1000 mL measuring flask, and fill up to 1000 mL meniscus). The turbidity value (TURB) of this solution is equivalent to 10 NTU.

4.6.1 Common zero calibration and span calibration < turbidity >

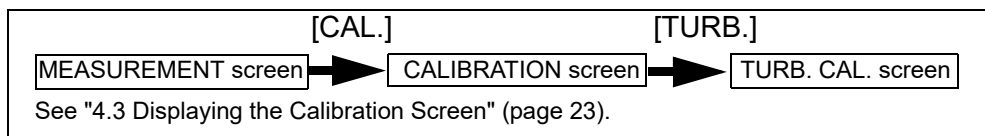

● Preparation

- Calibration tank...1
- Span standard solution... 1 L (Pour the solution into the calibration tank)
- Used fluid tank (Install it so that used fluid goes into the tank)

Note

Turbidity span calibration solution tends to settle. Shake thoroughly before using.

Prepare span calibration solution according to the measurement range (0 NTU to 2 NTU, 0 NTU to 5 NTU, or 0 NTU to 10 NTU).

Reference

"5.10.2 Setting the range for turbidity and color" (page 101).

● Calibration procedure

Perform calibration in the order: common zero calibration → span calibration.

● **Common zero calibration**

Note

In common zero calibration, zero calibration is performed at the same time for the three measurement items: turbidity, color and residual chlorine. Therefore it is not necessary to perform zero calibration individually for turbidity, color and residual chlorine. In addition, you do not need to readjust the flow rate.

1. Press [COMMON] on the CALIBRATION screen.

A confirmation screen is displayed asking whether to start calibration.

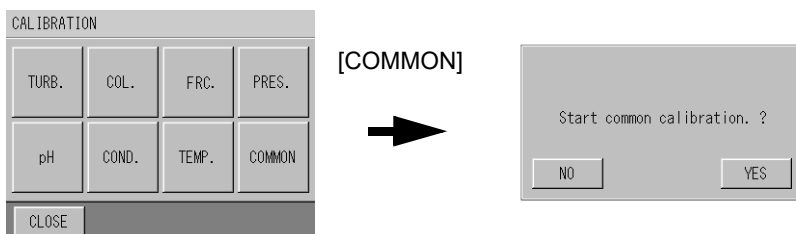

2. Press [YES] to start common calibration.

The COMMON ZERO CAL. screen is displayed. Wait until the calibration is completed (10 minutes).

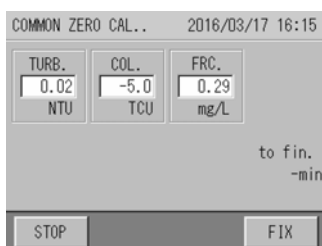

Tip

[FIX]: Forcibly stops the calibration and updates it without waiting for automatic completion

[STOP]: Stops the calibration

The RESULT screen is displayed.

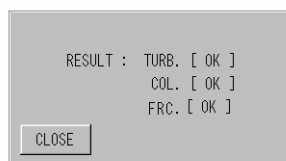

3. Press [CLOSE].

The zero calibration coefficients for turbidity, color and residual chlorine are updated.

● **Span calibration <turbidity>**

1. Place the calibration tank with span calibration solution beside the device.
2. Connect the tank to the calibration inlet of the device.

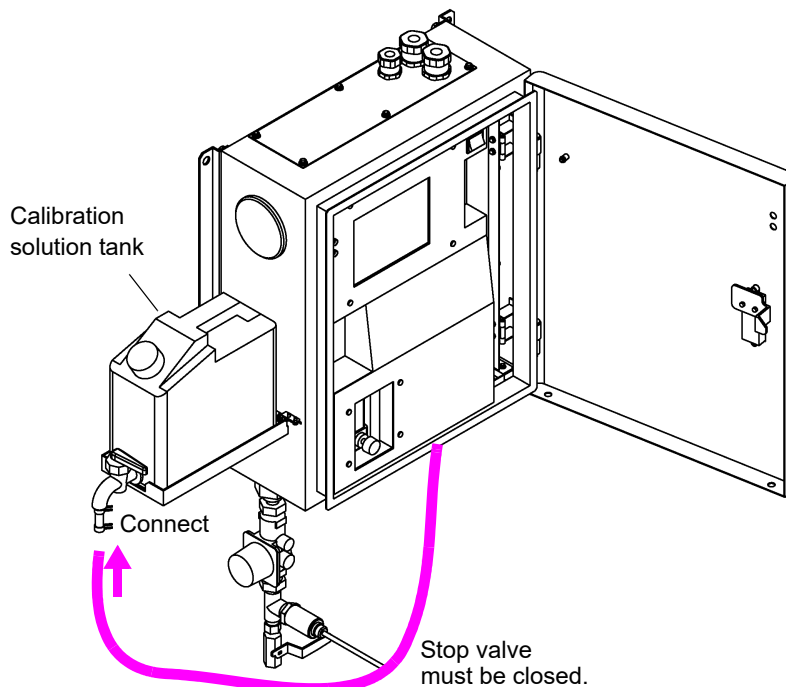

3. Press the **SPAN VALUE** button ([x.xx]) on the **TURB. CAL.** screen. The span calibration value input screen is displayed.

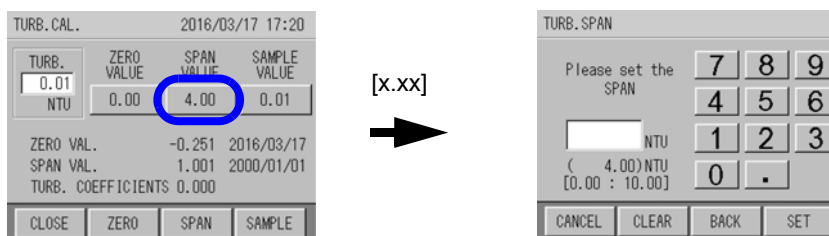

4. Enter the span calibration value using the numerical key pad and press **[SET]**.
Input range: 0.00 NTU to 10.00 NTU

Tip

[CLEAR]: Clears the whole value.

[BACK]: Deletes the rightmost number of the value.

The screen returns to the **TURB. CAL.** screen.

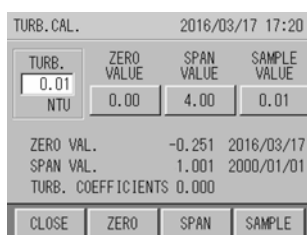

5. Open the valve of the calibration tank.

6. Press [SPAN].

A confirmation screen is displayed asking whether to start calibration.

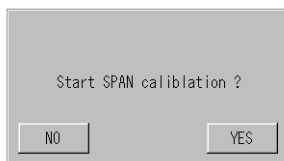

7. Press [YES] to start span calibration.

The screen shows that the calibration is in progress.

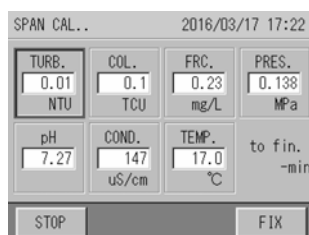

8. Adjust the flow rate to 50 mL/min using the valve.

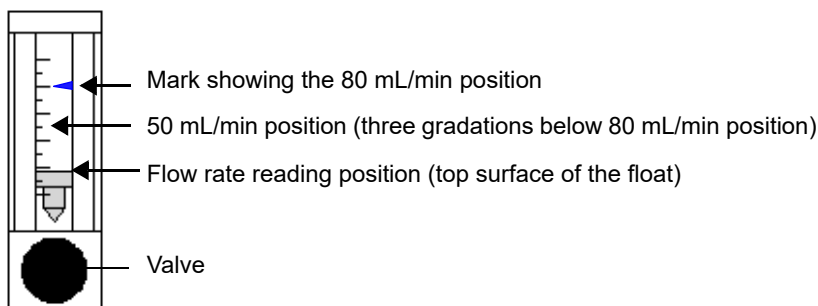

Wait until the calibration is completed (10 minutes).

Tip

[FIX]: Forcibly stops the calibration and updates it without waiting for automatic completion
 [STOP]: Stops the calibration

Note

- 1. Stop the calibration sequence.
- 2. Perform drainage operation and automatic cleaning operation.
- 3. When the instrument becomes stable, repeat the calibration.

The screen shows that the calibration is complete.

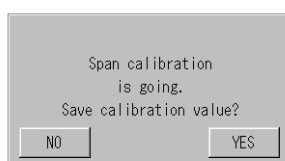

9. Press [YES].

The turbidity span calibration coefficient is updated.

10. Close the valve of the calibration tank.

11. Open the stop valve.

-
- 12. Adjust the flow rate of the sample water to 80 mL/min using the valve.**
 - 13. Disconnect the calibration tank from the calibration inlet of the device.**

4.6.2 Individual zero calibration and span calibration <turbidity>

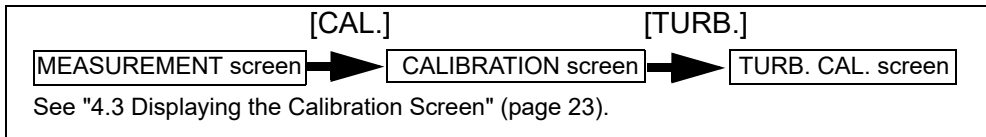

● **Preparation**

- Calibration tank...2
- Zero calibration solution... 1 L (Pour the solution into one of the calibration tanks)
- Span calibration solution... 1 L (Pour the solution into the other calibration tank)
- Used fluid tank (Install it so that used fluid goes into the tank)

● **Calibration procedure**

Perform calibration in the order: individual zero calibration → span calibration.

● **Individual zero calibration**

1. Place the calibration tank with zero liquid beside the device.
2. Connect the tank to the calibration inlet of the device.

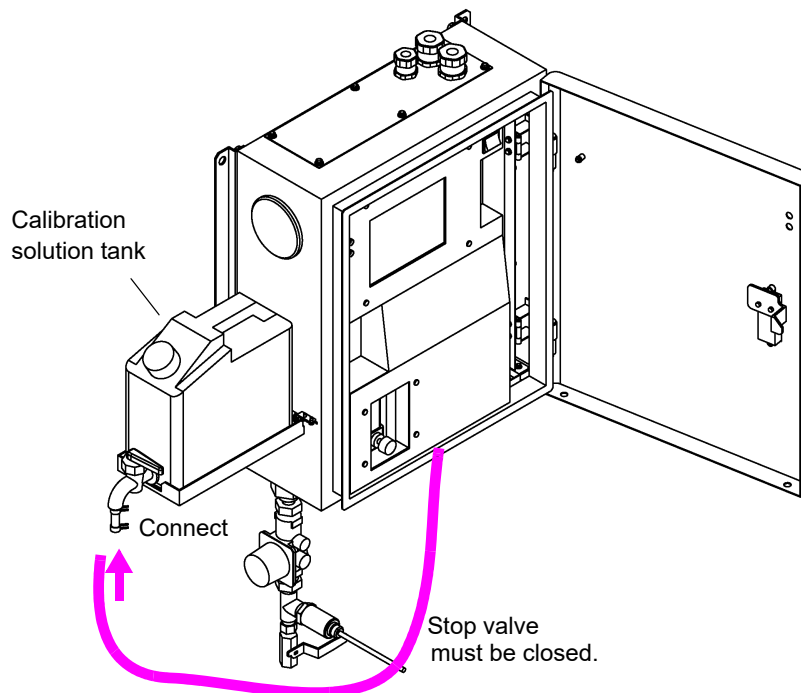

3. Press the ZERO VALUE button ([x.xx]) on the TURB. CAL. screen. The zero calibration value input screen is displayed.

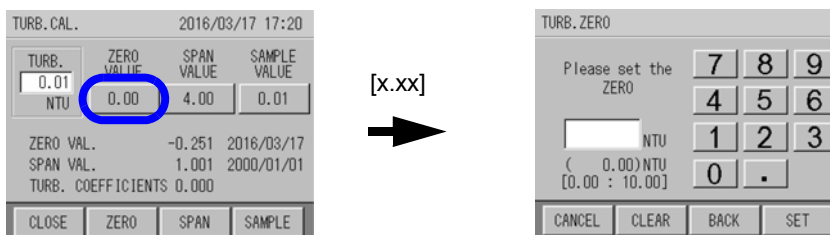

4. Enter the zero calibration value using the numerical key pad and press [SET].

Input range: 0.00 NTU to 10.00 NTU

Tip

[CLEAR]: Clears the whole value.

[BACK]: Deletes the rightmost number of the value.

The screen returns to the TURB. CAL. screen.

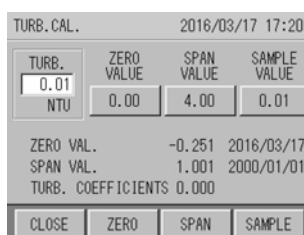

5. Open the valve of the calibration tank.

6. Press [ZERO].

A confirmation screen is displayed asking whether to start calibration.

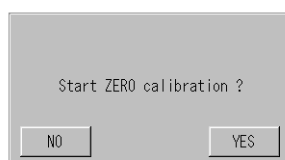

7. Press [YES] to start zero calibration.

The screen shows that the calibration is in progress.

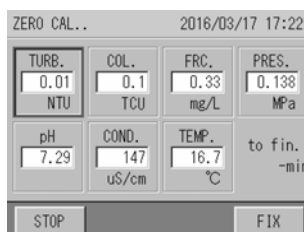

8. Adjust the flow rate to 50 mL/min using the flowmeter valve.

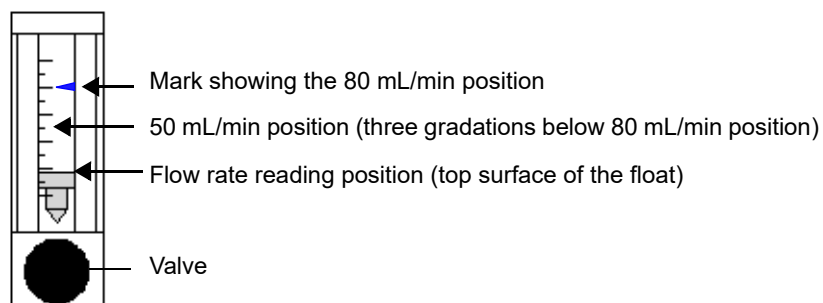

Wait until the calibration is completed (10 minutes).

Tip

[FIX]: Forcibly stops the calibration and updates it without waiting for automatic completion

[STOP]: Stops the calibration

The screen shows that the calibration is complete.

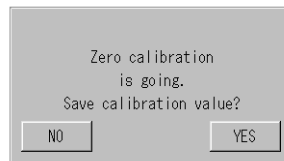

9. Press [YES].

The turbidity zero calibration coefficient is updated.

10. Close the valve of the calibration tank.

11. Disconnect the calibration tank from the calibration inlet of the device.

● **Span calibration <turbidity>**

Follow the instructions given in " ● Span calibration <turbidity>" (page 45).

4.6.3 Adjustment calibration using sample water <turbidity>

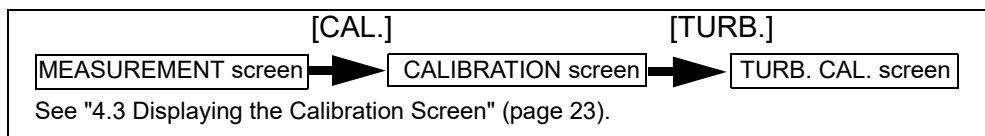

● Preparation

- Turbidity meter...1

● Calibration procedure

1. Measure turbidity of the prepared sample water using a turbidity meter other than this device's and calculate the value.
2. Press the **SAMPLE VALUE** button ([x.xx]) on the **TURB. CAL.** screen.
The sample water calibration value input screen is displayed.

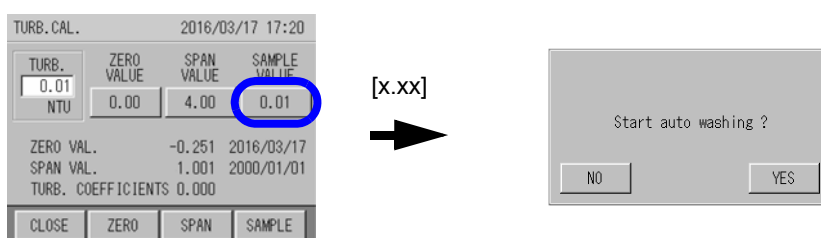

3. Enter the measured value of the sample water using the numerical key pad and press **[SET]**.

Input range: 0.00 NTU to 10.00 NTU

Tip

[CLEAR]: Clears the whole value.

[BACK]: Deletes the rightmost number of the value.

The screen returns to the **TURB. CAL.** screen.

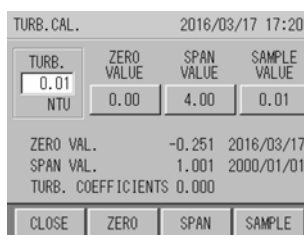

4. Press **[SAMPLE]**.

A confirmation screen is displayed asking whether to start calibration.

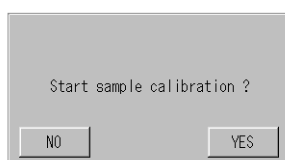

5. Press [YES] to start sample water calibration.

The screen shows that the calibration is in progress.
Wait until the calibration is completed.

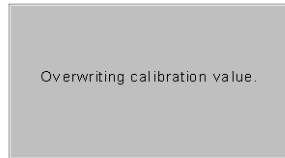

The screen shows that the calibration is complete.

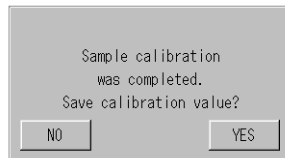

6. Press [YES].

The turbidity zero calibration coefficient is updated.

4.7 Conductivity Calibration (Optional)

Conductivity is optional.

There are two calibration patterns for conductivity. See "4.1 Calibration Patterns and Cycles" (page 17) and select one of the patterns.

● <Reference> Making conductivity span calibration solution

JIS	Reagent	Amount (per 1 L)
JIS-K8121	Potassium chloride	0.744 g

Quoted from JIS-K0101

1. Potassium chloride

Grind potassium chloride (for conductivity measurement use) stipulated in JIS-K8121 in an agate mortar to make it into a powder, heat it up to 500°C for approximately four hours, and then leave it in a desiccator to cool.

2. 147 $\mu\text{S}/\text{cm}$ (25°C) potassium chloride standard solution preparation

Measure and put 0.744 g of potassium chloride into a 1000 mL flask and fill it with purified water up to the gauge line. Put 100 mL of this solution into another 1000 mL flask and fill it with purified water up to the gauge line.

4.7.1 Span calibration <conductivity>

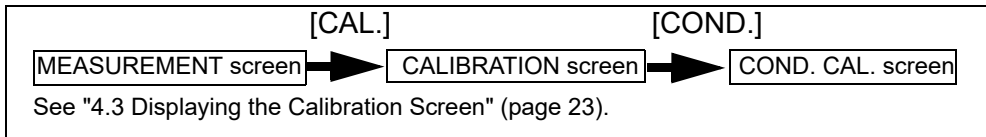

● **Preparation**

- Calibration tank...1
- Span standard solution... 1 L (Pour the solution into the calibration tank)
- Used fluid tank (Install it so that used fluid goes into the tank)

● **Calibration procedure**

1. Place the calibration tank with span calibration solution beside the device.
2. Connect the tank to the calibration inlet of the device.

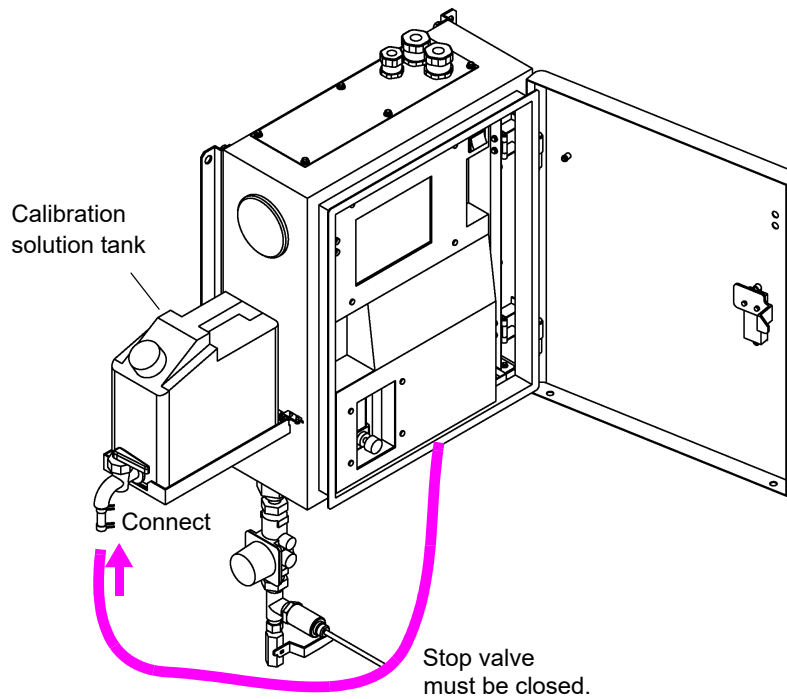

3. Press the **SPAN VALUE** button ([xx.x]) on the **COND. CAL.** screen. The span calibration value input screen is displayed.

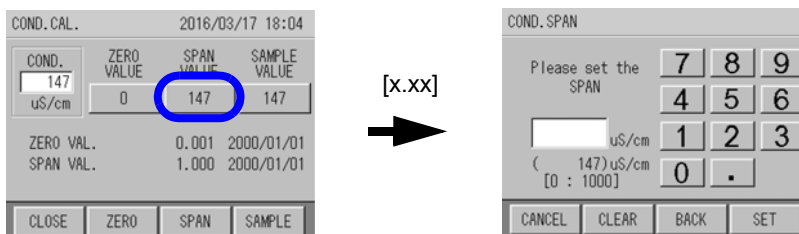

4. Enter the span calibration value using the numerical key pad and press [SET].

Input range: 0 $\mu\text{S}/\text{cm}$ to 1000 $\mu\text{S}/\text{cm}$

Tip

[CLEAR]: Clears the whole value.

[BACK]: Deletes the rightmost number of the value.

The screen returns to the COND. CAL. screen.

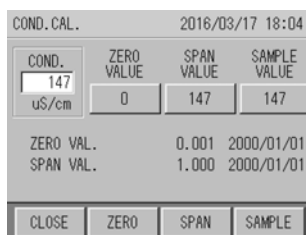
5. Open the valve of the calibration tank.
6. Press [SPAN].

A confirmation screen is displayed asking whether to start calibration.

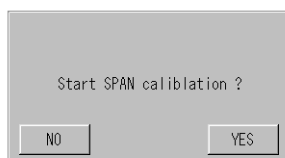
7. Press [YES] to start span calibration.

The screen shows that the calibration is in progress.

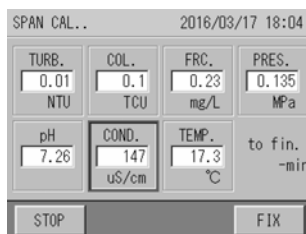
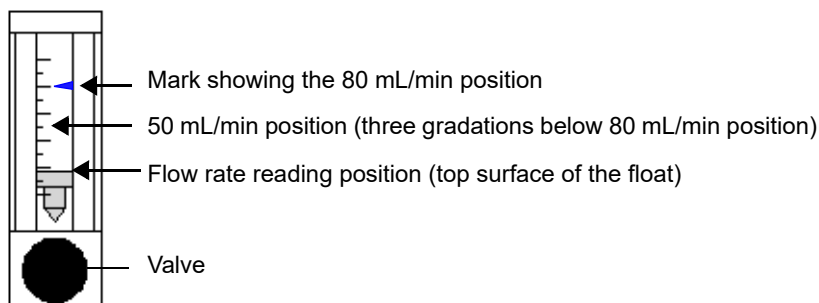
8. Adjust the flow rate to 50 mL/min using the valve.

Wait until the calibration is completed (10 minutes).

Tip

[FIX]: Forcibly stops the calibration and updates it without waiting for automatic completion

[STOP]: Stops the calibration

The screen shows that the calibration is complete.

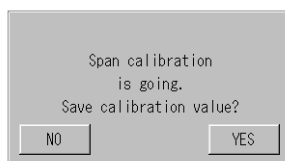

- 9. Press [YES].**
The conductivity span calibration coefficient is updated.
- 10. Close the valve of the calibration tank.**
- 11. Open the stop valve.**
- 12. Adjust the flow rate of the sample water to 80 mL/min using the valve.**
- 13. Disconnect the calibration tank from the calibration inlet of the device.**

4.7.2 Individual zero calibration <conductivity>

This is an open zero calibration. Perform calibration only when an abnormality occurs.

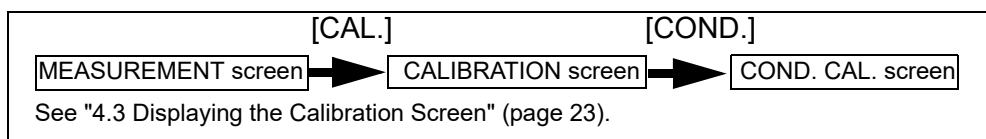

● Calibration procedure

1. Close the stop valve.

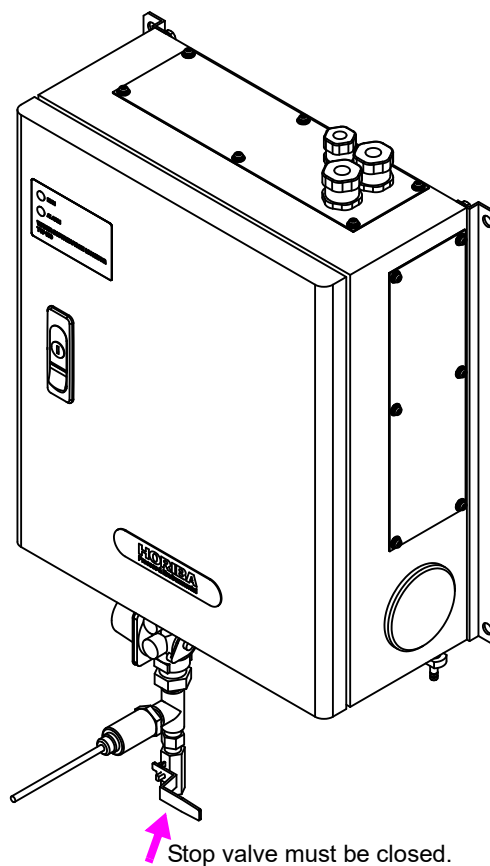

2. Start the water discharge action operation.

Reference

See "5.11 Action" (page 105).

3. Turn off the power.

4. Open the inner door of the device.

Reference

See "2.1 Opening the Inner Door of the Device" (page 7).

5. Remove the conductivity sensor from the residual chlorine/conductivity cell.

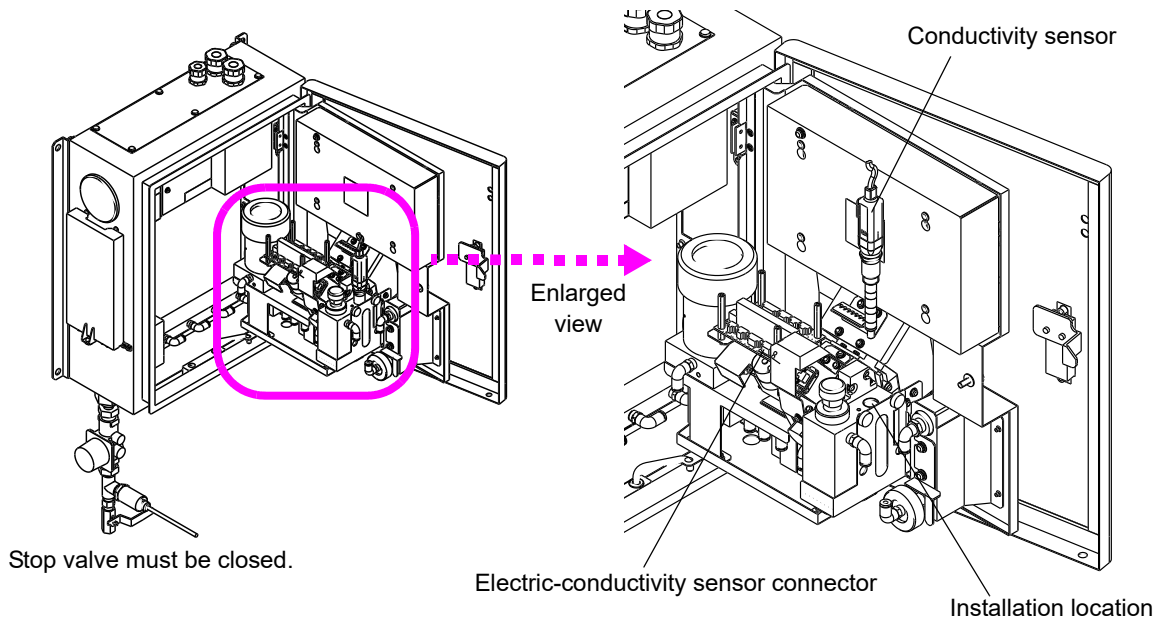

6. Completely dry the electric conductivity sensor using paper, such as filter paper.

Note

Be careful not to scratch the sensor.

7. Turn ON the power.

8. Press the ZERO VALUE button ([x.x]) on the TURB. CAL. screen.

The zero calibration value input screen is displayed.

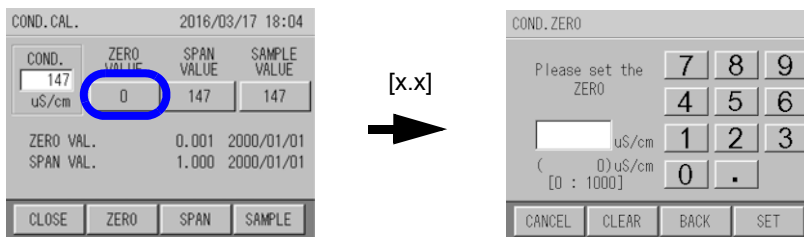

9. Enter 0 using the numerical key pad and press [SET].

Tip

[CLEAR]: Clears the whole value.

[BACK]: Deletes the rightmost number of the value.

The screen returns to the COND. CAL. screen.

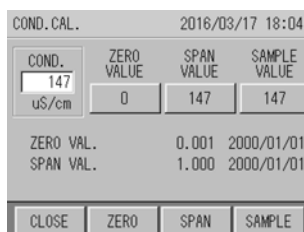

10. Press [ZERO] on the COND. CAL. screen.

A screen is displayed asking whether to start calibration.

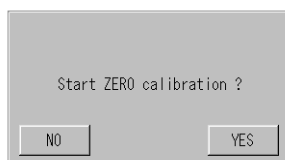

11. Press [YES] to start zero calibration.

The screen shows that the calibration is in progress.

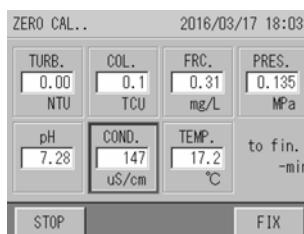

12. When the value becomes stable, press [FIX].

A confirmation screen is displayed.

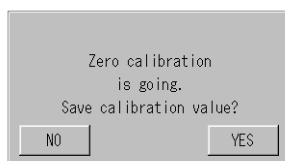

13. Press [YES].

The conductivity zero calibration coefficient is updated.

14. Turn off the power.

15. Install the conductivity sensor to the residual chlorine/conductivity cell.

16. Close the inner door of the device.

17. Open the stop valve.

18. Turn ON the power.

4.7.3 Adjustment calibration using sample water <conductivity>

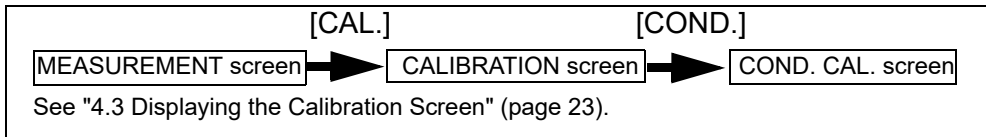

● **Preparation**

- Conductivity meter...1

● **Calibration procedure**

1. Measure electric conductivity of the prepared sample water using a conductivity meter other than the device's and calculate the value.
2. Press the **SAMPLE VALUE** button ([xx.x]) on the COND. CAL. screen.
The sample water calibration value input screen is displayed.

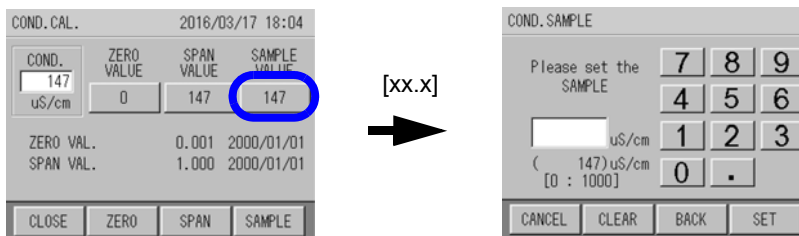

3. Enter the measured value of the sample water using the numerical key pad and press **[SET]**.
Input range: 0 μ S/cm to 1000 μ S/cm

Tip

- [CLEAR]: Clears the whole value.
- [BACK]: Deletes the rightmost number of the value.

The screen returns to the COND. CAL. screen.

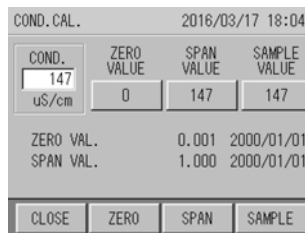

4. Press **[SAMPLE]**.

A confirmation screen is displayed asking whether to start calibration.

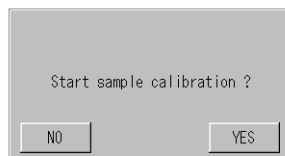

5. Press [YES] to start sample water calibration.

The screen shows that the calibration is in progress.
Wait until the calibration is completed.

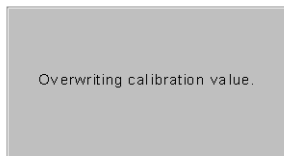

The screen shows that the calibration is complete.

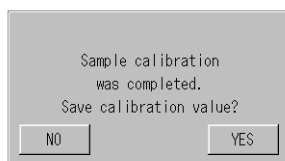
**6. Press [YES].**

The conductivity span calibration coefficient is updated.

4.8 Calibrating Residual Chlorine

There are three calibrating patterns for residual chlorine, not including automatic zero calibration.

See "4.1 Calibration Patterns and Cycles" (page 17) and select one of the patterns.

It is necessary to prepare span calibration solution, however, it is difficult to prepare residual-chlorine solution with correct concentration and the concentration may change soon after preparation. To achieve correct calibration, adjustment with sample water is recommended instead.

See "5.3 Automatic Zero Calibration" (page 82) for automatic zero calibration settings.

4.8.1 Adjustment calibration using sample water <residual chlorine>

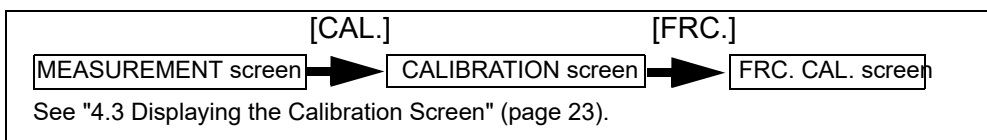

● **Preparation**

- Residual-chlorine meter...1

● **Calibration procedure**

- 1. Measure residual chlorine of the prepared sample water using a residual chlorine meter other than this device's and calculate the value.**
- 2. Press the SAMPLE VALUE button ([x.xx]) on the FRC. CAL. screen.**
The sample water calibration value input screen is displayed.

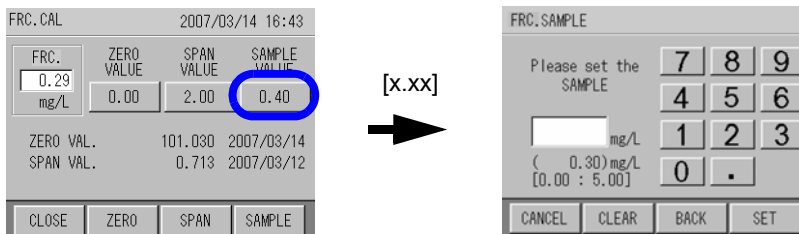

- 3. Enter the measured value of the sample water using the numerical key pad and press [SET].**

Input range: 0.00 mg/L to 5.00 mg/L

Tip

[CLEAR]: Clears the whole value.

[BACK]: Deletes the rightmost number of the value.

The screen returns to the FRC. CAL. screen.

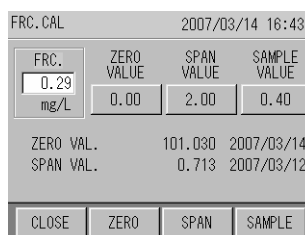

4. Press [SAMPLE].

A confirmation screen is displayed asking whether to start calibration.

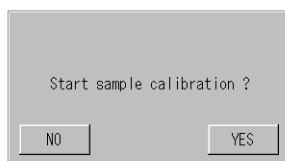
**5. Press [YES] to start sample water calibration.**

The screen shows that the calibration is in progress.

Wait until the calibration is completed.

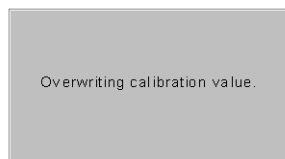

The screen shows that the calibration is complete.

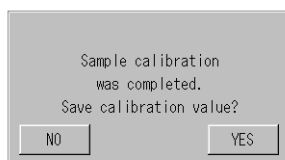
**6. Press [YES].**

The residual chlorine span calibration coefficient is updated.

4.8.2 <Reference> Common zero calibration and span calibration <residual chlorine>

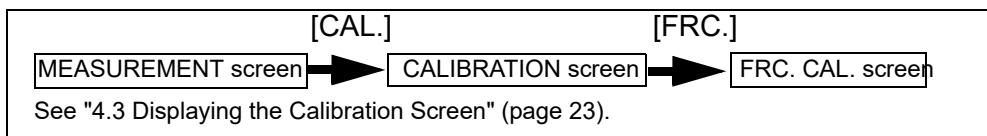

● Preparation

- Calibration tank...1
- Span standard solution...1 L (Pour the solution into the calibration tank)
- Used fluid tank (Install it so that used fluid goes into the tank)

● Calibration procedure

Perform calibration in the order: common zero calibration → span calibration.

● <Reference> Making residual-chlorine span calibration solution

● Sodium hypochlorite standard solution

Reagent	Approximate amount
Sodium hypochlorite	35 μ L
HORIBA pH 7 standard solution (No. 150-7)	0.34 g

Put 35 μ L of commercial sodium hypochlorite solution (approximate) into a 1000 mL flask, add approximately 0.34 g of HORIBA pH 7 standard solution powder (Cat. No. 150-7), and then fill it with purified water up to the gauge line. Use this solution to determine the residual-chlorine value according to the procedure in JIS-K0101.

Note

- The amount of sodium hypochlorite mentioned above is an approximate amount. Sodium hypochlorite concentration varies depending on reagent manufacturers and storing conditions. Adjust the loadings so that the residual chlorine concentration is within 2 mg/L.
- Adjust the loadings of potassium chloride and pH adjuster so that the values of the pH and conductivity in the calibration solution match the sample water. Titrate the calibration solution based on the iodometric titration flow method in JIS-K0101 and determine residual-chlorine concentration.

● Common zero calibration

Note

In common zero calibration, zero calibration is performed at the same time for the three measurement items: turbidity, color and residual chlorine. Therefore it is not necessary to perform zero calibration individually for turbidity, color and residual chlorine. In addition, you do not need to readjust the flow rate.

1. Press [COMMON] on the CALIBRATION screen.

A confirmation screen is displayed asking whether to start calibration.

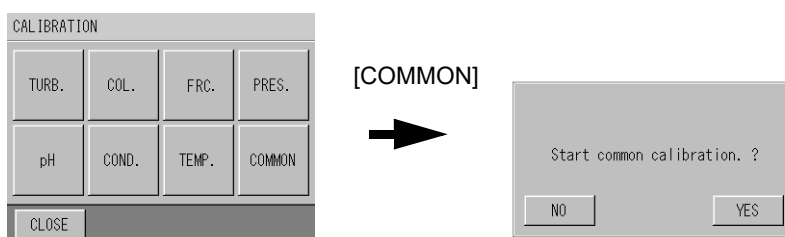

2. Press [YES] to start common calibration.

The COMMON ZERO CAL .. screen is displayed.

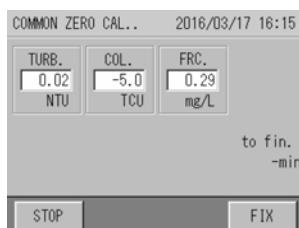

Wait until the calibration is completed (10 minutes).

Tip

[FIX]: Forcibly stops the calibration and updates it without waiting for automatic completion

[STOP]: Stops the calibration

The RESULT screen is displayed.

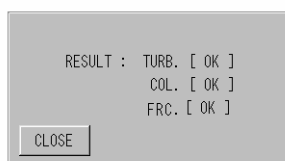

3. Press [CLOSE].

The zero calibration coefficients for turbidity, color and residual chlorine are updated.

● **Span calibration <residual chlorine>**

1. Place the calibration solution tank with span calibration solution more than 170 cm above from the drain pipe outlet; instead of placing it on the calibration tank tray beside the device.
2. Connect the tank to the calibration inlet of the device.

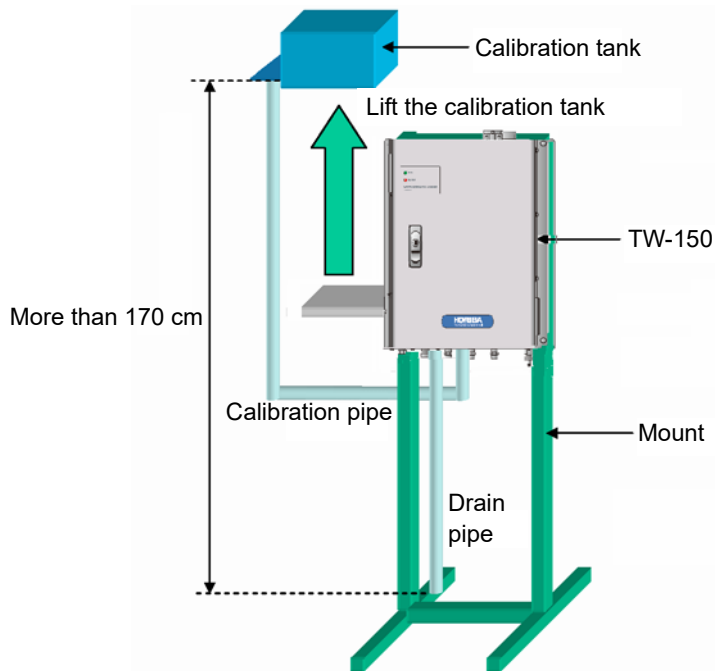

3. Press the **SPAN VALUE** button ([x.xx]) on the **FRC. CAL.** screen. The span calibration value input screen is displayed.

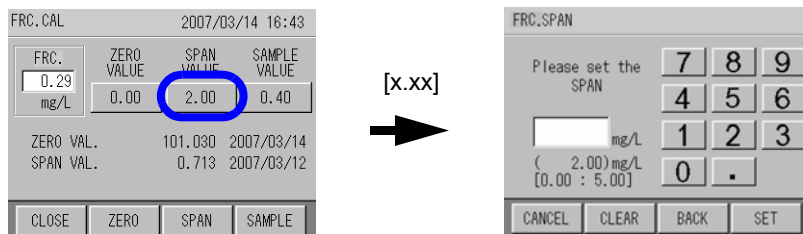

4. Enter the span calibration value using the numerical key pad, and press **[SET]**. Input range: 0.00 mg/L to 5.00 mg/L

Tip

- [CLEAR]:** Clears the whole value.
- [BACK]:** Deletes the rightmost number of the value.

The screen returns to the **FRC. CAL.** screen.

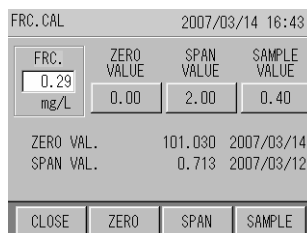

5. Open the valve of the calibration tank.

6. Press [SPAN].

A confirmation screen is displayed asking whether to start calibration.

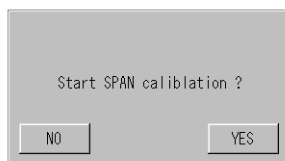
**7. Press [YES] to start span calibration.**

The screen shows that the calibration is in progress.

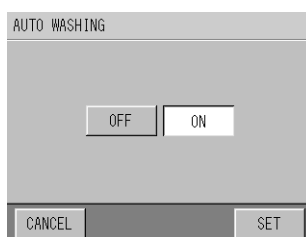
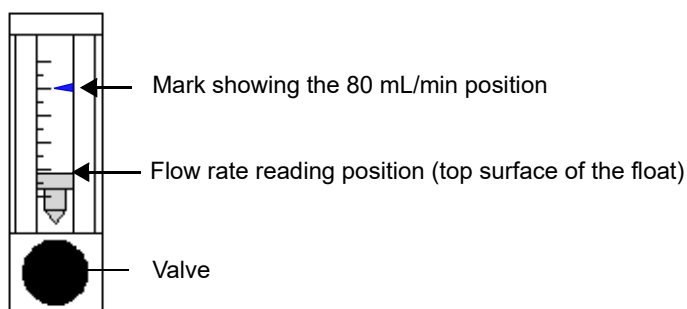
**8. Adjust the flow rate to 80 mL/min using the valve.**

Wait until the calibration is completed (10 minutes).

Tip

[FIX]: Forcibly stops the calibration and updates it without waiting for automatic completion
[STOP]: Stops the calibration

The screen shows that the calibration is complete.

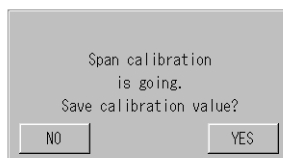
**9. Press [YES].**

The residual-chlorine span calibration coefficient is updated.

10. Close the valve of the calibration tank.**11. Open the stop valve.****12. Adjust the flow rate of the sample water to 80 mL/min using the valve.****13. Disconnect the calibration tank from the calibration inlet of the device.**

4.8.3 <Reference> Individual zero calibration and span calibration <residual chlorine>

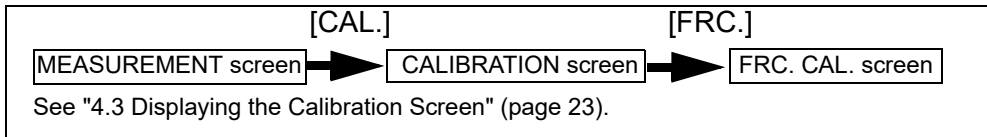

● **Preparation**

- Calibration tank...2
- Zero standard solution...1 L (Pour the solution into one of the calibration tanks)
- Span standard solution...1 L (Pour the solution into the other calibration tank)
- Used fluid tank (Install it so that used fluid goes into the tank)

● **Calibration procedure**

Perform calibration in the order: individual zero calibration → span calibration.

● **Individual zero calibration**

1. Place the calibration solution tank with zero liquid more than 170 cm above from the drain pipe outlet; instead of placing it on the calibration tank tray bFRC.eside the device.
2. Connect the tank to the calibration inlet of the device.

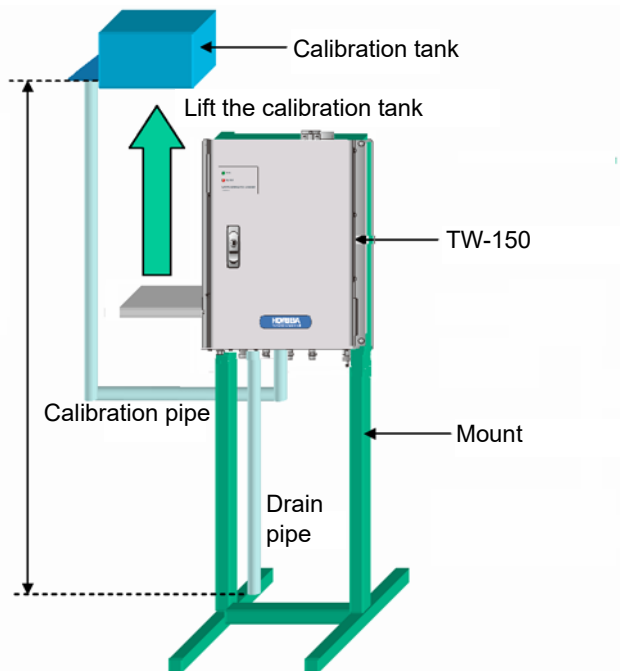

3. Press the ZERO VALUE button ([x.xx]) on the FRC. CAL. screen. The zero calibration value input screen is displayed.

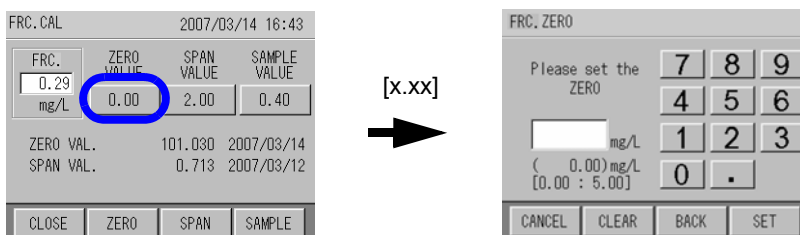

4. Enter the zero calibration value using the numerical key pad and press [SET].

Input range: 0.00 mg/L to 5.00 mg/L

Tip

[CLEAR]: Clears the whole value.

[BACK]: Deletes the rightmost number of the value.

The screen returns to the FRC. CAL. screen.

FRC.	ZERO VALUE	SPAN VALUE	SAMPLE VALUE
0.29 mg/L	0.00	2.00	0.40
ZERO VAL.	101.030	2007/03/14	
SPAN VAL.	0.713	2007/03/12	
CLOSE	ZERO	SPAN	SAMPLE

5. Open the valve of the calibration tank.

6. Press [ZERO].

A confirmation screen is displayed asking whether to start calibration.

Start ZERO calibration ?	
NO	YES

7. Press [YES] to start zero calibration.

The screen shows that the calibration is in progress.

TURB.	COL.	FRC.	PRES.
0.00 NTU	0.1 TCU	0.31 mg/L	0.135 MPa
pH 7.30	COND. 147 uS/cm	TEMP. 17.1 °C	to fin. -min
STOP		FIX	

8. Adjust the flow rate to 80 mL/min using the flowmeter valve.

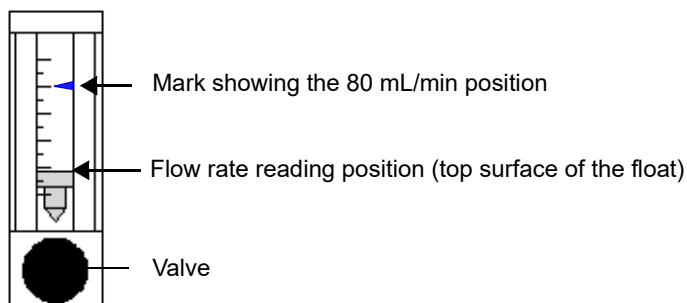

Wait until the calibration is completed (10 minutes).

Tip

[FIX]: Forcibly stops the calibration and updates it without waiting for automatic completion

[STOP]: Stops the calibration

The screen shows that the calibration is complete.

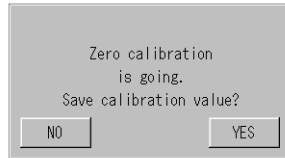

9. Press [YES].

The residual-chlorine zero calibration coefficient is updated.

10. Close the valve of the calibration tank.

11. Disconnect the calibration tank from the calibration inlet of the device.

● **Span calibration <residual chlorine>**

Follow the instructions given in " ● Span calibration <residual chlorine>" (page 66) .

4.9 Calibrating Water Pressure

Water pressure is already calibrated before shipment, so additional calibration is unnecessary. The calibration procedure is given as a reference. Only when an abnormality occurs, check that the calibration coefficient is not far from the manually-analyzed value.

4.9.1 Adjustment calibration using sample water <water pressure>

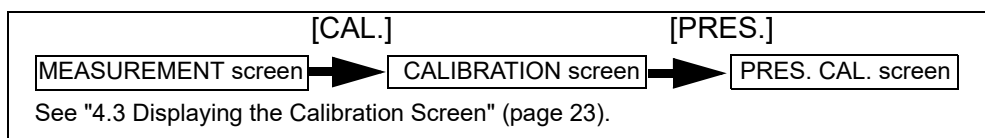

● Preparation

- Water pressure meter...1

● Calibration procedure

1. Measure water pressure of the sample water using a water pressure meter other than this device's and calculate the value.
2. Press the **SAMPLE VALUE** button ([x.xxx]) on the **PRES. CAL.** screen.
The sample water calibration value input screen is displayed.

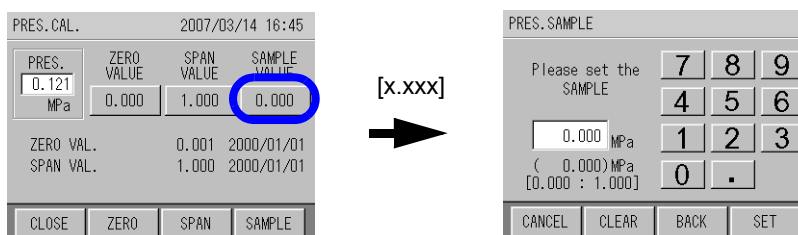

3. Enter the manually-analyzed value of the sample water using the numerical key pad and press **[SET]**.

Input range: 0.000 MPa to 1.000 MPa

Tip

[CLEAR]: Clears the whole value.

[BACK]: Deletes the rightmost number of the value.

The screen returns to the **PRES. CAL.** screen.

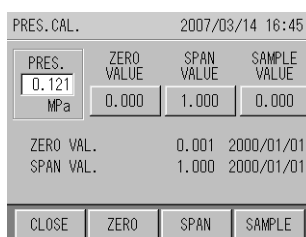

4. Press **[SAMPLE]**.

A confirmation screen is displayed asking whether to start calibration.

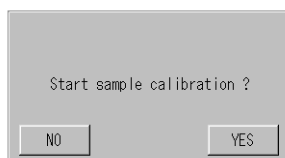

5. Press [YES] to start sample water calibration.

The screen shows that the calibration is in progress.

Wait until the calibration is completed.

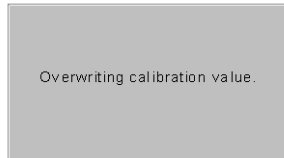

The screen shows that the calibration is complete.

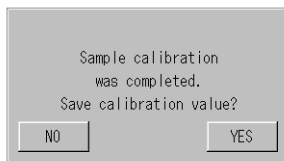

6. Press [YES].

The water pressure zero calibration coefficient is updated.

4.10 Calibrating Water Temperature

Water temperature is optional.

Water temperature is already calibrated before shipment, so additional calibration is unnecessary. The calibration procedure is given as a reference. Only when an abnormality occurs, check that the calibration value is not far from the manually-analyzed value.

4.10.1 Adjustment calibration using sample water <water temperature>

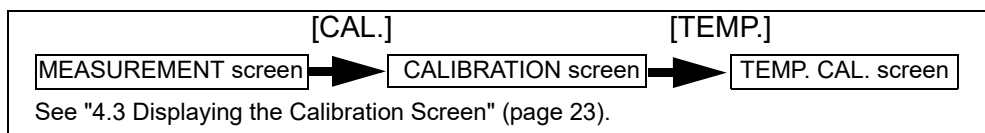

● Preparation

- Thermometer...1

● Calibration procedure

1. Measure water temperature of the sample water using a thermometer other than this device's and calculate the value.
2. Press the **SAMPLE VALUE** button ([xx.x]) on the **TEMP. CAL.** screen. The sample water calibration value input screen is displayed.

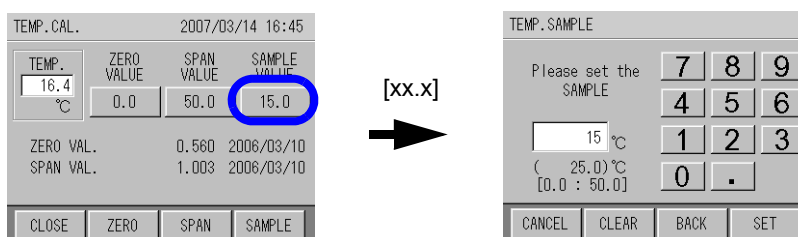

3. Enter the measured temperature of the sample water using the numerical key pad and press **[SET]**.
Input range: 0.0°C to 50.0°C

Tip

[CLEAR]: Clears the whole value.

[BACK]: Deletes the rightmost number of the value.

The screen returns to the **TEMP. CAL.** screen.

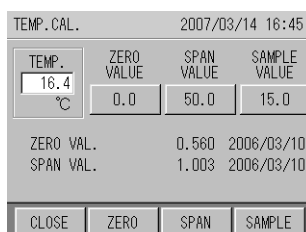

4. Press **[SAMPLE]**.

A confirmation screen is displayed asking whether to start calibration.

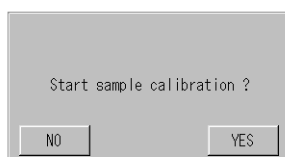

5. Press [YES] to start sample water calibration.

The screen shows that the calibration is in progress.

Wait until the calibration is completed.

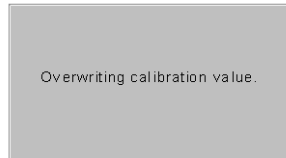

The screen shows that the calibration is complete.

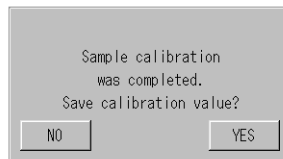

6. Press [YES].

The water temperature zero calibration coefficient is updated.

5 FUNCTION

This device has many features, but in order to obtain the best performance, you must first configure the device. This section describes the functions and how to configure the settings.

5.1 Function List

Thoroughly learn the available functions to be able to configure and utilize them to meet your customers' needs.

Function		Detail	Reference
SETTING 1/2	I/O Settings	Settings for receiving input from external devices and for outputting information during operation.	"5.2 Input/Output Settings" (page 78)
	Automatic zero calibration	The device regularly performs zero calibration automatically. This function secures the stability of the measurement value for the turbidity, the color, and the residual chlorine.	"● Calibration information" (page 19), "5.3 Automatic Zero Calibration" (page 82)
	Auto Washing	The windows of the turbidity and color sensors accumulate dirt from sample water. Also, air bubbles and dirt must be removed since they affect the measurement value. The automatic cleaning feature periodically uses a wiper to clean the cells.	"5.4 Auto Washing" (page 84)
	Sampling	Keeps some of sample water when a malfunction occurs while measuring.	"5.6 Water Sampling" (page 91)
	Auto Draining	Auto draining is a function to regularly remove dirt from the measurement cell and tubes with air bubbles and water draining so that measurements remain accurate.	"5.5 Auto Draining" (page 87)
SETTING 2/2	Clock Adjustment	Adjust the clock.	"5.7 Clock Adjustment" (page 94)
	LCD	Configure LCD (display) settings.	"5.8 LCD Setting" (page 95)
	Touch Panel Adjustment	Calibrates the location of the touch panel.	"5.9 Touch Panel Adjustment" (page 97)
	Maker Maintenance Mode	This setting is used by the manufacturer. This setting is not used in normal operation.	–
CALIBRATION		Set the measurement range or coefficient for each measurement item	"5.10 Measurement Settings" (page 98)
ACTION	Auto Washing	Start the cleaning of the turbidity/color cells by using buttons.	"5.11 Action" (page 105)
	Check Alarm	Check the source of an alarm (sensor or sample water).	
	Meas. (ZERO)	Measure the zero calibration water.	
	Meas. (SPAN)	Measure the calibration solution.	
	Drain	Drain the water from the cell only one time.	
	Sampling Checking	Obtain sample water by using buttons.	
	Auto Drain	Repeat the drain sequence as specified in "AUTO DRAIN SETTING".	
Device Status Checking		Check information such as the unit ID and analog input/output.	"5.12 Checking the Device Status" (page 107)
Data check		Check the log data and histories, and transfer data to a memory card.	"5.13 Data Check" (page 110)

5 FUNCTION

Function	Detail	Reference
Alarm	An alarm occurs when a malfunction occurs in sample water or the device.	"5.14 Alarm" (page 119)

● **Displaying the maintenance item screen**

1. Press [Mainte.] on the MEASUREMENT screen.

The MAINTENANCE screen is displayed.

2. Select a maintenance item using buttons that are displayed in the MAINTENANCE screen.

The MAINTENANCE item screen is displayed.

MAINTENANCE screen operation button	Screen name
[SETTING]	SETTING screen
[MEAS. SETTING]	CALIBRATION screen
[ACTION]	ACTION screen
[CHECK]	CHECK screen

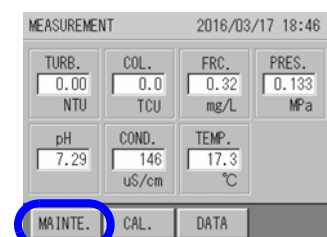

MEASUREMENT screen → [MAINT.]

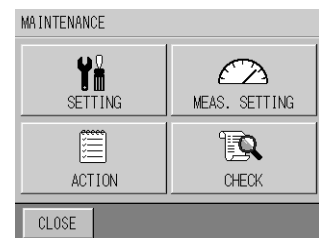

MAINTENANCE screen

[SETTING]

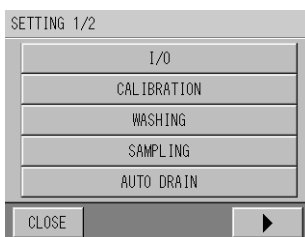

SETTING 1/2 screen

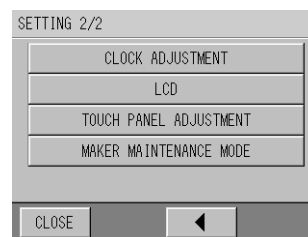

SETTING 2/2 screen



[MEAS. SETTING]

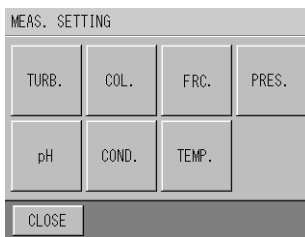

CALIBRATION screen

[ACTION]



ACTION 1/2 screen

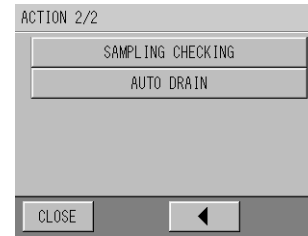

ACTION 2/2 screen



[CHECK]

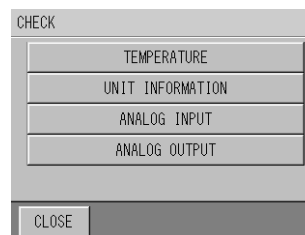

CHECK screen

5.2 Input/Output Settings

You can configure the following settings related to input/output.

Setting	Explanation	Initial Setting
EXT. I/O IN (5.2.1, page 79)	Select the method for external input. However, you must configure the handling of abnormal water sampling separately. (page 92)	OFF
ALG. OUT (MAINTE.) (5.2.2, page 79)	Select what kind of value is output when the device is in maintenance mode ^{*1} .	HOLD ^{*2}
ALG. OUT (SEQ.) (5.2.2, page 79)	Select what kind of value is output when performing ACTION operations.	HOLD ^{*2}
ALG. OUT(ALARM) (5.2.2, page 79)	Select what kind of value is output when an alarm occurs.	HOLD ^{*2}
WARMING UP (5.2.2, page 79)	Select what kind of value to output when turning ON the power and warming up.	Preset 4.0 mA
ANALOG OUTPUT LEVEL (5.2.3, page 81)	Selects the range of the analog output value.	4 mA to 20 mA
ALARM TIM (5.14.5, page 122)	See "5.14 Alarm" (page 119).	5 minutes
DISPLAYING MINUS (5.2.4, page 81)	You can select to output the value with subtraction sign or to display a blinking "0" when a measurement value is less than 0. This setting is useful when you need to know that a measurement value is negative, but do not need to know its exact value. [*] This setting does not apply to water temperature (optional).	OFF

^{*1} Maintenance mode: The mode that the device is in when you press [MAINTE.] or [CAL] and the MAINTENANCE or CAL. screen is displayed.

^{*2} HOLD: Maintain the last measured value.

● The I/O SETTING screen

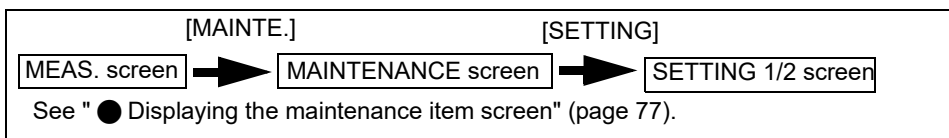

1. Press [I/O] on the SETTING 1/2 screen.

The I/O SETTING screen is displayed.

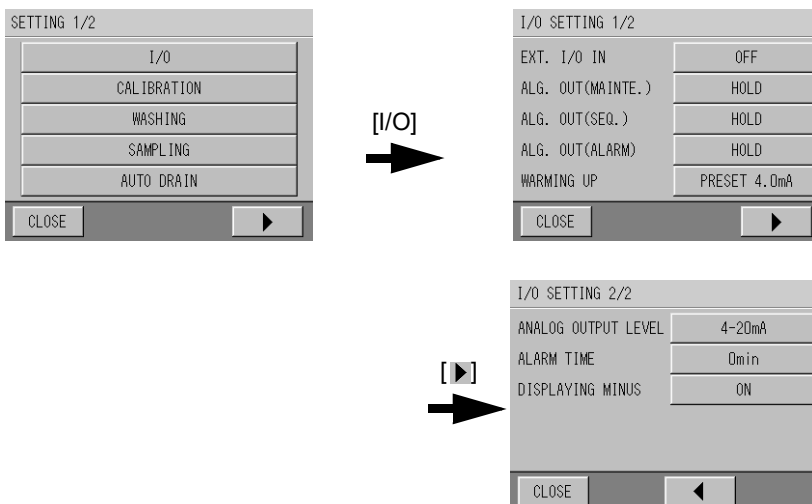

5.2.1 Setting EXT I/O IN

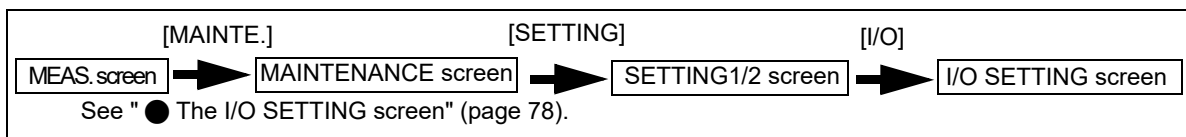

1. Press the **EXT I/O IN SETTING** button on the **I/O SETTING 1/2** screen. The EXT. I/O IN SETTING screen is displayed.

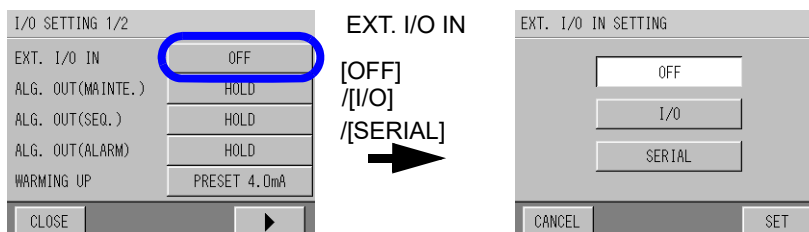

2. Select the items by using the buttons, and press **[SET]**.

Item	Explanation
OFF	Button operation only (No external input).
Contact	Accept input using the contact connection.
SERIAL	Accept input using the RS-232C connection.

Return to the I/O SETTING 1/2 screen.

5.2.2 Setting external output during operation

This section explains the following 4 output setting methods.

- ALG. OUT (MAINTE.)
- ALG. OUT (SEQ.)
- ALG. OUT (ALARM)
- WARMING UP

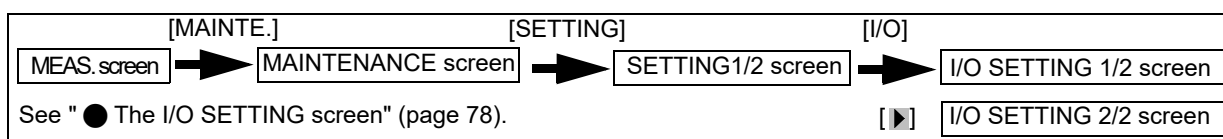

1. Press the button for output item to configure on the **I/O SETTING 1/2** screen.

- ALG. OUT (MAINTE.)
- ALG. OUT (SEQ.)
- ALG. OUT (ALARM)
- WARMING UP

The corresponding screen for each item is displayed.

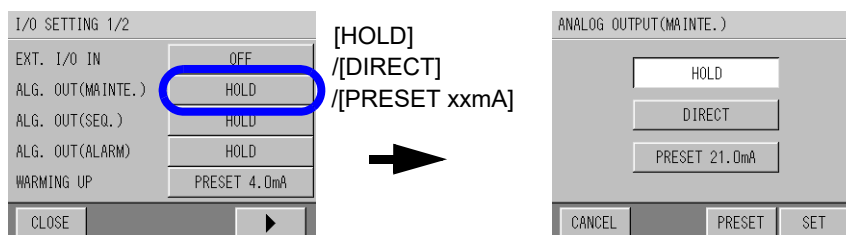

* This example shows the screen for maintenance mode output.

2. Select the items by using the buttons, and press [SET].

Item	Explanation	Initial Setting
HOLD	Hold and output the last measured value. If there is no last measured value when turning ON the power, the last value measured before turning OFF the power is held.	–
DIRECT	Outputs the actual measured value.	–
PRESET	Output a set value. The log data will contain the value that is equivalent to the set value.	MAINT./SEQ./ALARM: 21.0 mA WARMING UP: 4.0 mA

Returns to the I/O SETTING screen.

● **Setting the PRESET value**

1. Press [PRESET] in the lower-right portion of the screen.

The corresponding PRESET screen is displayed.

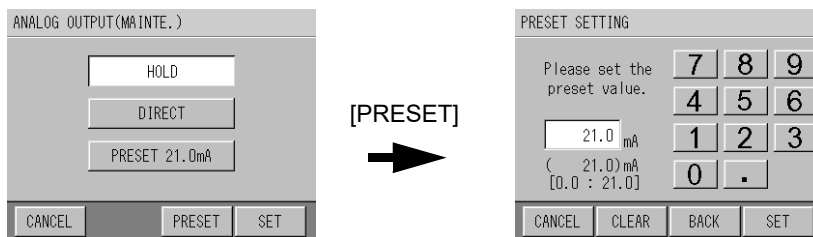

2. Enter the PRESET value using the numerical key pad and press [SET].

Input range: 0.0 mA to 21.0 mA

5.2.3 Setting the analog output level

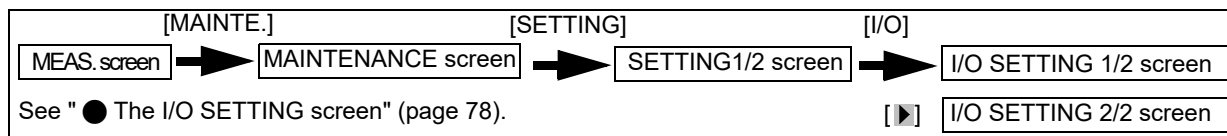

1. Press the **ANALOG OUTPUT LEVEL** button on the **I/O SETTING 2/2** screen.
The ANALOG OUTPUT LEVEL screen is displayed.

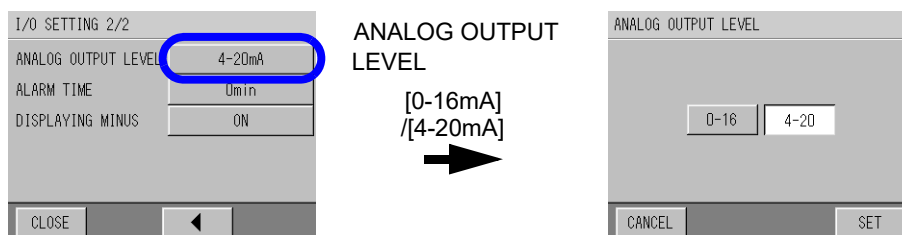

2. Select the **[0-16]** or **[4-20]** button, and press **[SET]**.
Returns to the I/O SETTING screen.

5.2.4 Setting DISPLAYING MINUS

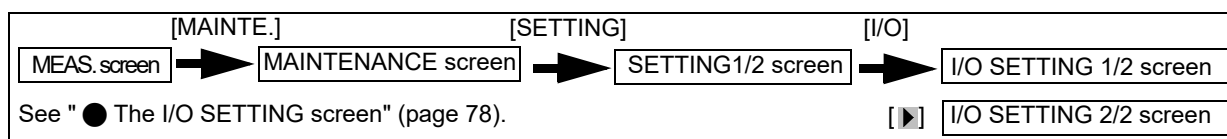

1. Press the **DISPLAYING MINUS** button on the **I/O SETTING 2/2** screen.
The DISPLAYING MINUS screen is displayed.

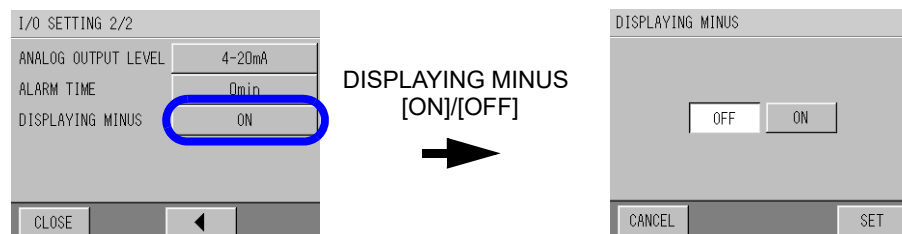

2. Select the **[ON]** or **[OFF]** button, and press **[SET]**.
Returns to the I/O SETTING screen.

Tip

When changing the setting while the measurement value is being held, the new setting is available after the HOLD is released.

5.3 Automatic Zero Calibration

To secure a stable measurement value, zero calibration is performed automatically at a constant interval. Zero calibration is performed for turbidity, color and residual chlorine measurements. Zero-standard solution which filtered sample water is used.

Note

To perform the automatic zero calibration, set the EXT I/O IN to OFF. For details, see "5.2.1 Setting EXT I/O IN" (page 79) .

The following settings are available for zero calibration.

Setting	Explanation	Initial Setting
Setting ON/OFF of ZERO CAL. (5.3.1, page 82)	Specifies whether ZERO CAL. is activated or not.	ON
Calibration interval (5.3.2, page 83)	Sets the calibration interval.	24 hours
STANDARD TIME (5.3.3, page 83)	Sets the time to perform zero calibration. Performs zero calibration periodically from the specified time.	2004/01/01/00:00

● **Displaying CALIBRATION SETTING screen**

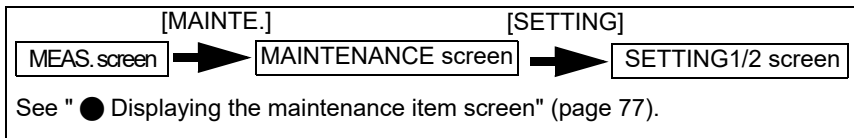

1. Press **[CALIBRATION]** on the **SETTING 1/2** screen.
The **CALIBRATION SETTING** screen is displayed.

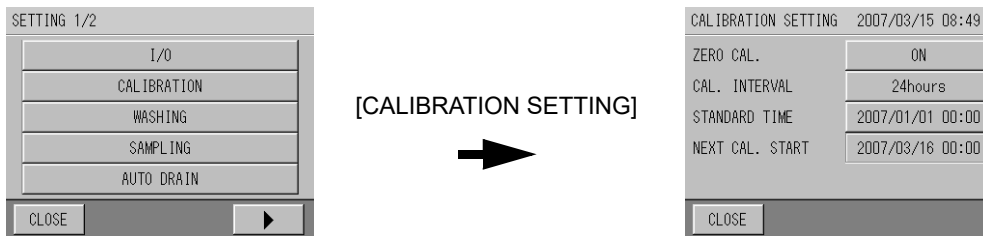

5.3.1 Setting ON/OFF of ZERO CAL.

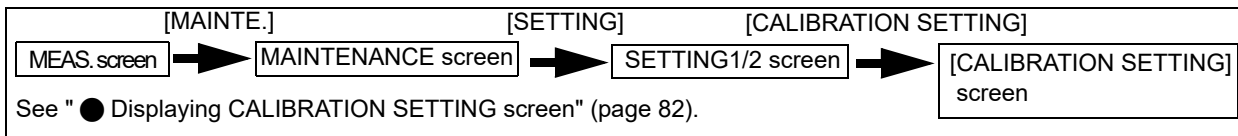

1. Press the **ZERO CAL.** button on the **CALIBRATION SETTING** screen.
The **ZERO CAL. SETTING** screen is displayed.

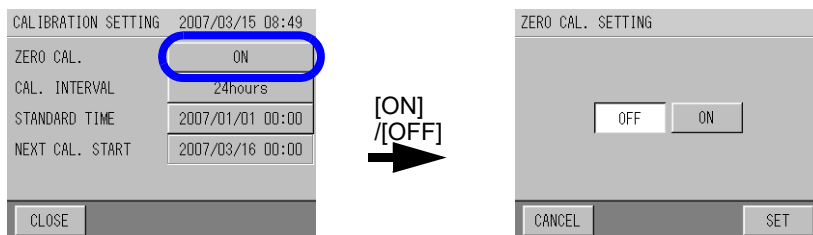

2. Select **[ON]** or **[OFF]**, and press **[SET]**.
The screen returns to the **CALIBRATION SETTING** screen.

5.3.2 Setting the calibration interval

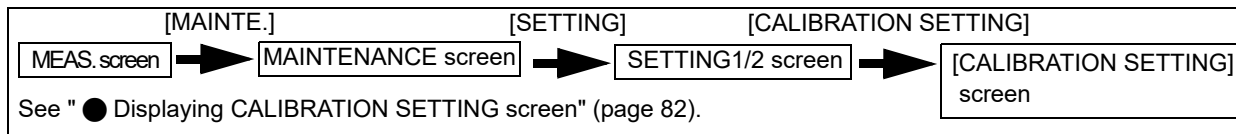

1. Press the **CAL. INTERVAL** button on the **CALIBRATION SETTING** screen.
The **CAL. INTERVAL SETTING** screen is displayed.

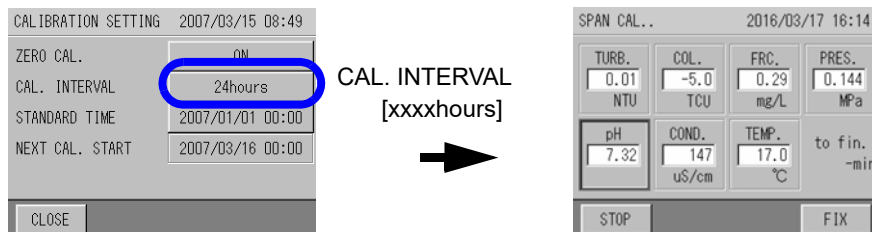

2. Enter the zero-calibration interval value using the numerical key pad and press **[SET]**.
Input range: 5 to 9999 (hours)

Tip

[CLEAR]: Clears the entire value.

[BACK]: Deletes the right-most number of the value.

The screen returns to the **CALIBRATION SETTING** screen.

5.3.3 Setting the STANDARD TIME

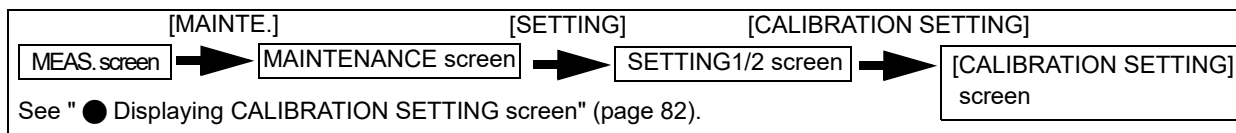

1. Press the **STANDARD TIME** button on the **CALIBRATION SETTING** screen.
The **STANDARD TIME** screen is displayed.



2. Press the button to be changed, and set the value with **[▲]** and **[▼]**. Enter the standard time of the **ZERO CAL.**, and press **[SET]**.
The screen returns to the **CALIBRATION SETTING** screen.

5.4 Auto Washing

If the windows of the measurement part of the turbidity and color sensors get dirty or form air bubbles on them, the correct values will not be measured. Auto washing is a function to regularly remove dirt and air bubbles from the measurement cell with a wiper so that measurements remain accurate.

Note

To perform auto washing, the EXT I/O IN setting to OFF. For details, see "5.2.1 Setting EXT I/O IN" (page 79).

The following are available for auto washing.

Setting	Explanation	Initial Setting
ON/OFF: AUTO WASHING (5.4.1, page 85)	Turns auto washing ON or OFF	ON
WASHING INTERVAL (5.4.2, page 85)	Set the interval to perform auto washing.	60 minutes
STANDARD TIME (5.4.3, page 86)	Set the time to start auto-washing. Starts the first auto washing at the set time, and washing is subsequently performed at the interval specified.	2004/01/01/00:30
WIPING TIME (5.4.4, page 86)	Set the number of times to wipe the window per wash.	1 time

● Displaying the AUTO WASHING SETTING screen

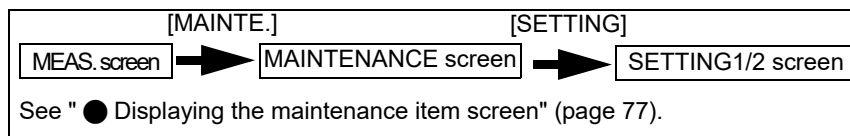

1. Press [WASHING] on the SETTING 1/2 screen.

The AUTO WASHING SETTING screen is displayed.



5.4.1 Turning auto washing ON and OFF

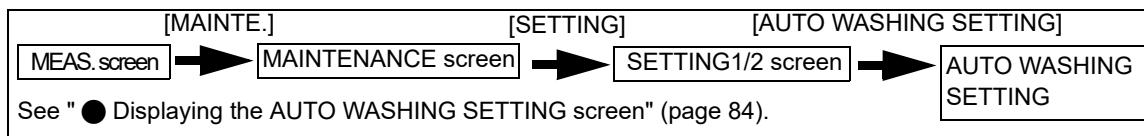

1. Press the **AUTO WASHING** button on the **AUTO WASHING SETTING** screen.
The **AUTO WASHING SETTING** screen is displayed.

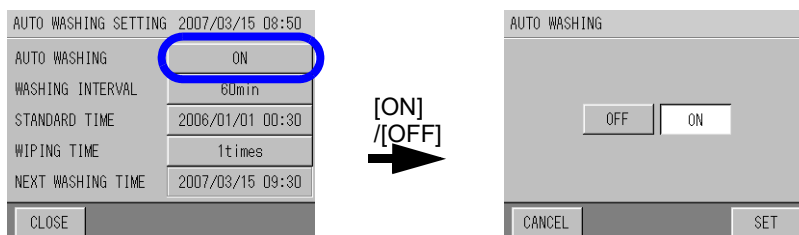

2. Select **[ON]** or **[OFF]**, and press **[SET]**.
Returns to the **AUTO WASHING SETTING** screen.

5.4.2 Setting the WASHING INTERVAL

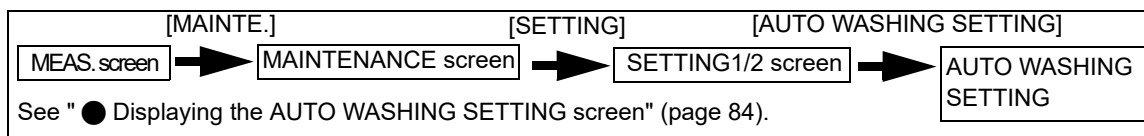

1. Press the **WASHING INTERVAL** button on the **AUTO WASHING SETTING** screen.
The **WASHING INTERVAL SETTING** screen is displayed.

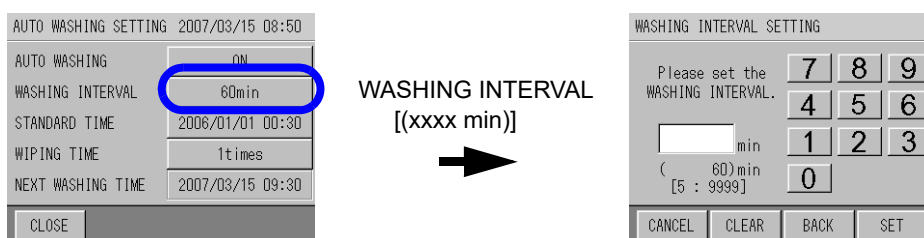

2. Enter the value of the **AUTO WASHING** interval using the numerical key pad and press **[SET]**.
Input range: 5 to 9999 (min)

Tip

[CLEAR]: Clears the whole value.

[BACK]: Deletes the right-most number of the value.

Returns to the **AUTO WASHING SETTING** screen.

5.4.3 Setting the STANDARD TIME

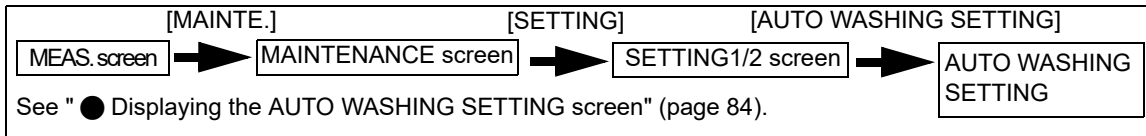

1. Press the **STANDARD TIME** button on the **AUTO WASHING SETTING** screen. The **STANDARD TIME** screen is displayed.



2. Press the button to be changed, and set the value with [▲] and [▼]. Enter the standard time of the **AUTO WASHING**, and press [SET]. Returns to the **AUTO WASHING SETTING** screen.

5.4.4 Setting the WIPING TIME

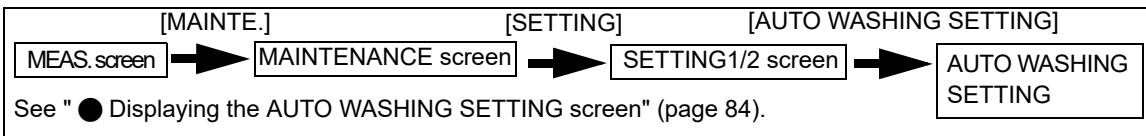

1. Press the **WIPING TIME** button on the **AUTO WASHING SETTING** screen. The **WIPING TIME** screen is displayed.

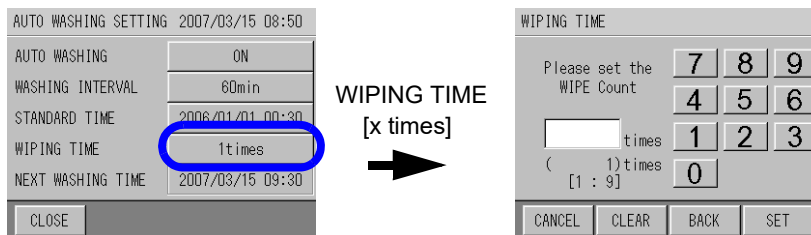

2. Enter the value of the wiping time using the numerical key pad, and press [SET]. Input range: 1 to 9 (times)

Tip

[CLEAR]: Clears the whole value.
 [BACK]: Deletes the right-most number of the value.

Returns to the **AUTO WASHING SETTING** screen.

5.5 Auto Draining

Auto draining is a function to regularly remove dirt from the measurement cell and tubes with air bubbles and water draining so that measurements remain accurate.

The following are available for auto drain.

Setting	Explanation	Initial Setting
ON/OFF: AUTO DRAIN (5.4.1, page 85)	Turns auto drain ON or OFF	ON
DRAIN INTERVAL (5.4.2, page 85)	Set the interval to perform auto drain.	60 minutes
STANDARD TIME (5.4.3, page 86)	Set the time to start auto-washing. Starts the first auto drain at the set time, and washing is subsequently performed at the interval specified.	2004/01/01/00:40
DRAIN TIME (5.4.4, page 86)	Set the frequency of the drain sequence.	1 time

● Displaying the AUTO DRAIN SETTING screen

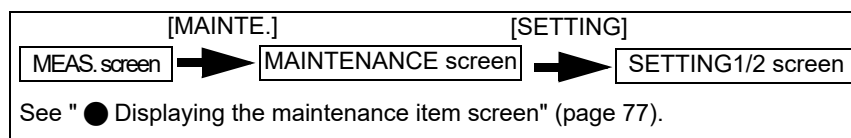

1. Press [WASHING] on the SETTING 1/2 screen.

The AUTO DRAIN SETTING screen is displayed.

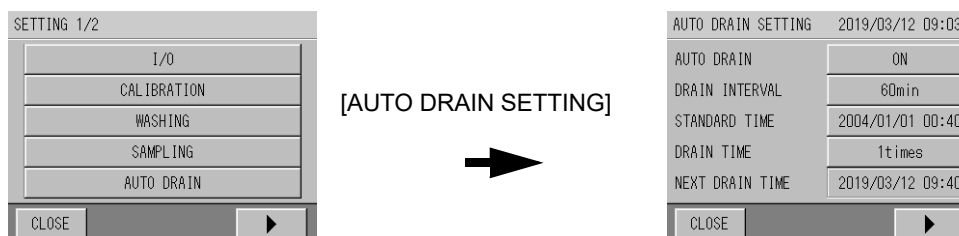

5.5.1 Turning auto draining ON and OFF

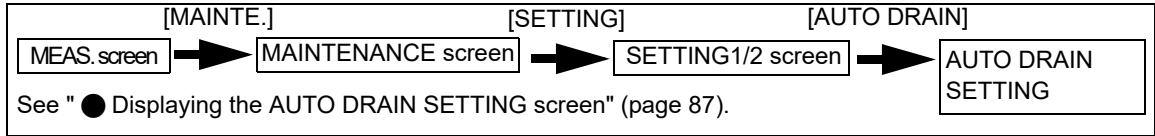

1. Press the **AUTO DRAIN** button on the **AUTO DRAIN SETTING** screen.
The **AUTO DRAIN** screen is displayed.

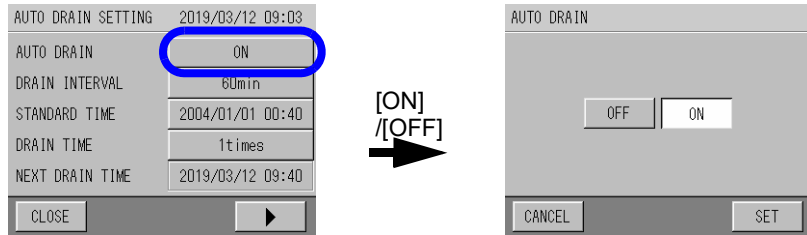

2. Select **[ON]** or **[OFF]**, and press **[SET]**.
Returns to the **AUTO DRAIN SETTING** screen.

5.5.2 Setting the DRAIN INTERVAL

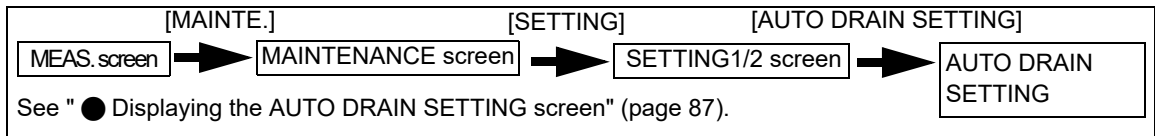

1. Press the **DRAIN INTERVAL** button on the **AUTO DRAIN SETTING** screen.
The **DRAIN INTERVAL SETTING** screen is displayed.

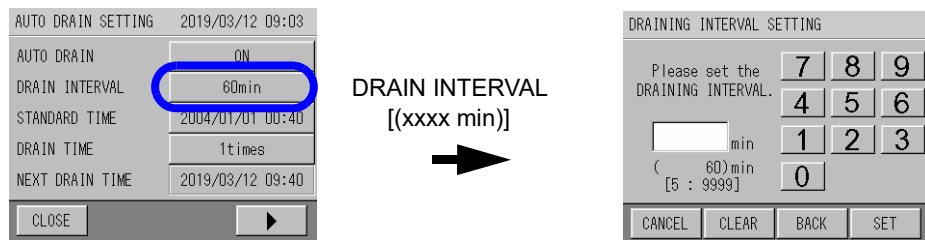

2. Enter the value of the **AUTO DRAIN** interval using the numerical key pad and press **[SET]**.

Input range: 5 to 9999 (min)

Tip

- [CLEAR]:** Clears the whole value.
- [BACK]:** Deletes the right-most number of the value.

Returns to the **AUTO DRAIN SETTING** screen.

5.5.3 Setting the STANDARD TIME

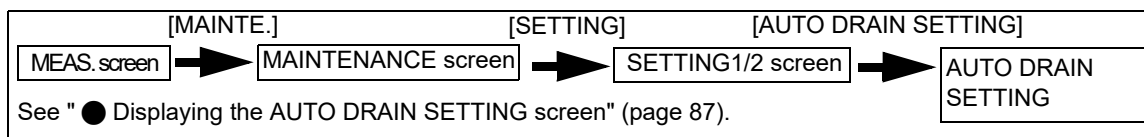

1. Press the **STANDARD TIME** button on the **AUTO DRAIN SETTING** screen.

The **STANDARD TIME** screen is displayed.



2. Press the button to be changed, and set the value with [▲] and [▼]. Enter the standard time of the **AUTO DRAIN**, and press [SET].

Returns to the **AUTO DRAIN SETTING** screen.

5.5.4 Setting the DRAIN TIME

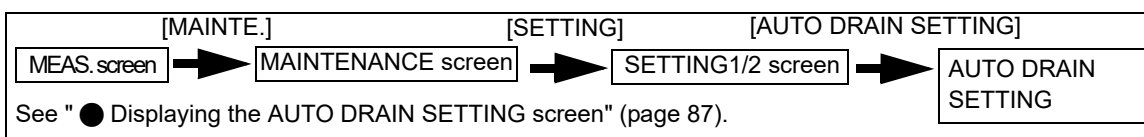

1. Press the **DRAIN TIME** button on the **AUTO DRAIN SETTING** screen.

The **DRAIN TIME** screen is displayed.

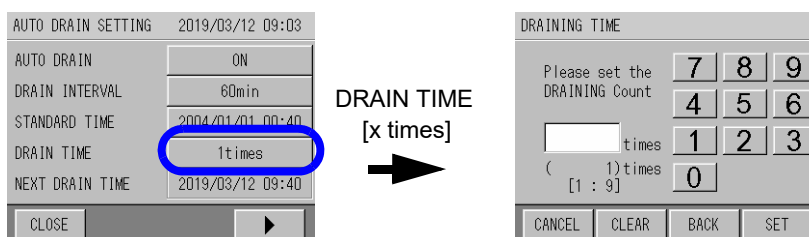

2. Enter the value of the draining time using the numerical key pad, and press [SET].

Input range: 1 to 9 (times)

Tip

[CLEAR]: Clears the whole value.

[BACK]: Deletes the right-most number of the value.

Returns to the **AUTO DRAIN SETTING** screen.

5.5.5 Setting the HOLD TIME

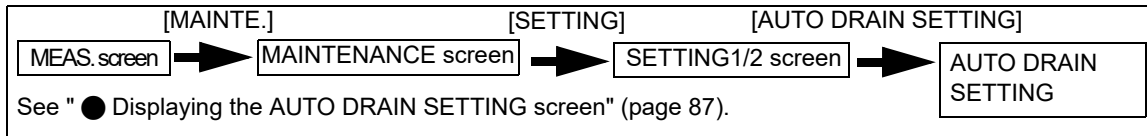

1. Press the HOLD TIME button on the AUTO DRAIN SETTING2/2 screen.
The OUTPUT HOLD TIME screen is displayed.

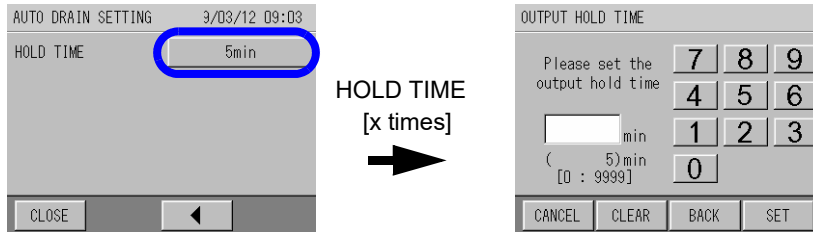

2. Enter the value of the output hold time using the numerical key pad, and press [SET].
Input range: 0 to 9999 (min)

Tip

[CLEAR]: Clears the whole value.
[BACK]: Deletes the right-most number of the value.

Returns to the AUTO DRAIN SETTING screen.

5.6 Water Sampling

This function stores sample water when a measurement malfunction occurs. During the set water sampling time, sample water is obtained from the abnormal water sampling inlet with a flow rate of 80 mL/min. It is necessary to connect a container to obtain sample water from the inlet.

Only the first malfunction is obtained, and the time is recorded. Once sample water has been obtained, the water sampling function is locked until reset. Sample water will not be obtained even if another malfunction occurs.

The following settings and functions are available for this feature.

Setting	Explanation	Initial Setting
Setting the SAMPLING CHECK (5.6.1, page 92)	Set the timing to obtain the sampling.	OFF
Setting the SAMPLING TIME (5.6.2, page 92)	Set the time to obtain the sampling.	10 minutes
Perform the SAMPLING RESET (5.6.3, page 93)	Obtains sample water once and releases the lock. When a reset is performed, "LAST SAMPLING TIME" is cleared from the display.	-

● Displaying the SAMPLING SETTING screen

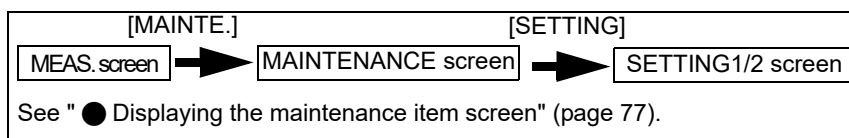

1. Press [SAMPLING] on the SETTING 1/2 screen.

The SAMPLING SETTING screen is displayed.

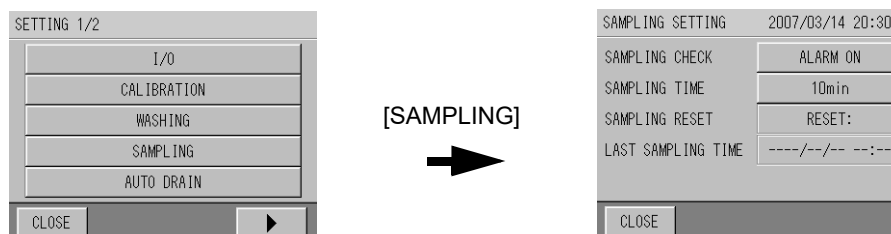

● The example of connection of the container to obtain a water sampling

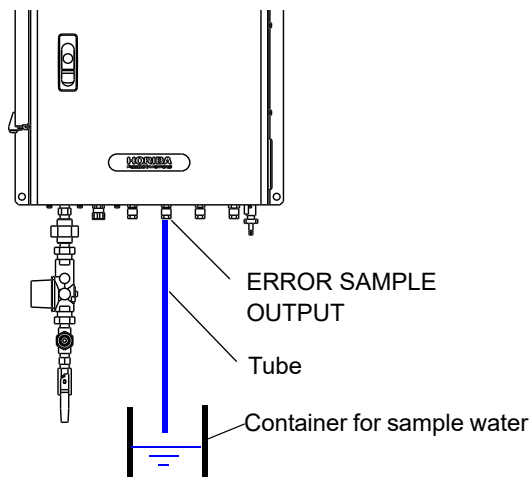

5.6.1 Setting the SAMPLING CHECK

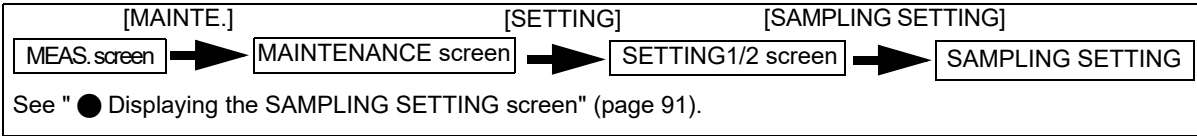

1. Press the **SAMPLING CHECK** button on the **SAMPLING SETTING** screen.
The **SAMPLING CHECK** screen is displayed.

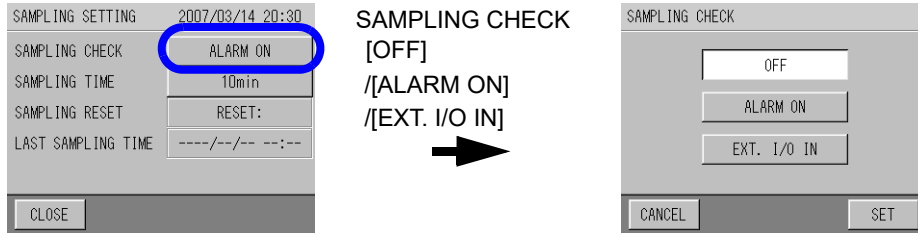

2. Select the settings using the buttons, and press **[SET]**.

Setting	Explanation
OFF	Sample water is not obtained.
ALARM ON	When an alarm for abnormal concentration occurs
EXT. I/O IN	When given a signal to obtain an abnormal-water sampling from the contact input or serial input

Returns to the **SAMPLING SETTING** screen.

5.6.2 Setting the SAMPLING TIME

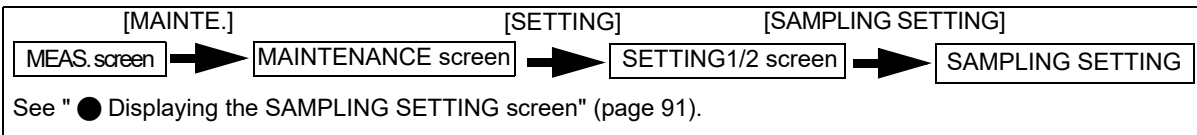

1. Press the **SAMPLING TIME** button on the **SAMPLING SETTING** screen.
The **SAMPLING TIME SETTING** screen is displayed.

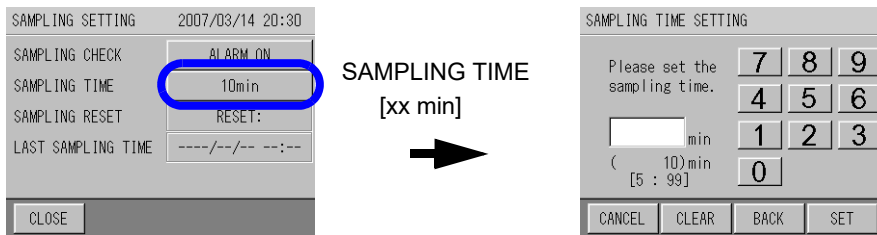

2. Enter the value of the water sampling time using the numerical key pad, and press **[SET]**.
Input range: 5 to 99 (min)

Note

Based on the water sampling time, select a container that is large enough to hold sample water.

Tip

[CLEAR]: Clears the whole value.
[BACK]: Deletes the right most number of the value.

Returns to the **SAMPLING SETTING** screen.

5.6.3 Perform the SAMPLING RESET

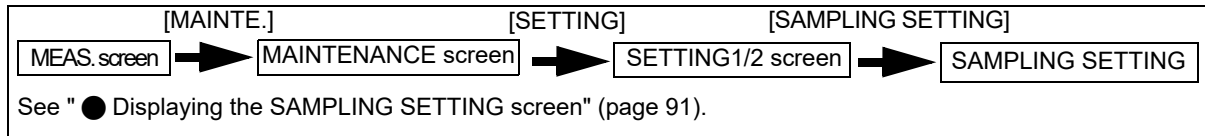

1. Press the SAMPLING RESET button on the SAMPLING SETTING screen.

A screen confirming whether or not whether or not to reset the sampling time is displayed.

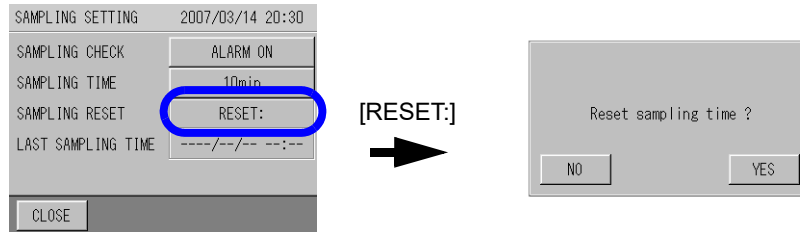

2. Press [YES].

Returns to the SAMPLING SETTING screen.

The lock is released, and sample water will be obtained again.

5.7 Clock Adjustment

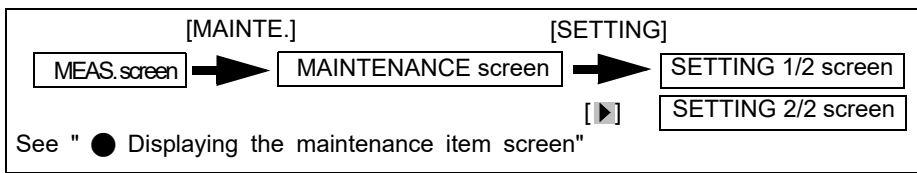

1. Press **[CLOCK ADJUSTMENT]** on the **SETTING 2/2** screen.
The **CLOCK ADJUSTMENT** screen is displayed.

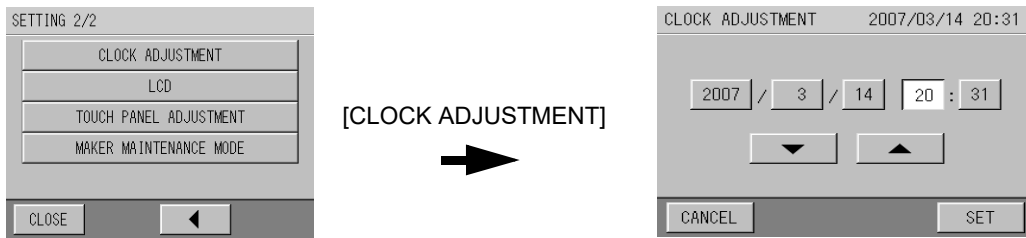

2. Press the button to be changed, and set the value with **[▲]** and **[▼]**. Input the time, then press **[SET]**.
Returns to the **SETTING** screen.

5.8 LCD Setting

The following settings are available for the LCD.

Setting	Description	Initial Setting
BACK LIGHT TIME (page 95)	Adjusts the amount of time before the backlight of the LCD (the display) is dimmed when there is no operation.	10 min
Brightness (page 96)	Controls the brightness of the LCD (the display).	-

● Displaying the LCD SETTING screen

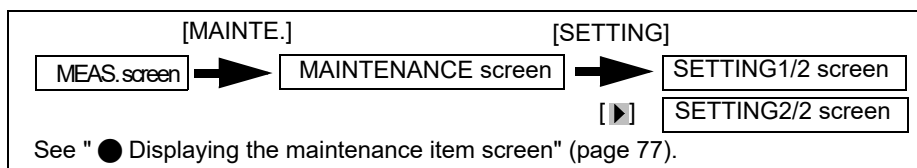

1. Press [LCD] on the SETTING 2/2 screen.

The LCD SETTING screen is displayed.

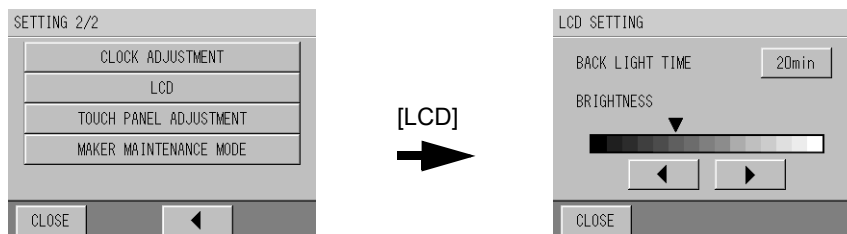

Tip

When there is no operation for 30 minutes, the display returns to the previous screen.

5.8.1 Setting the BACK LIGHT TIME

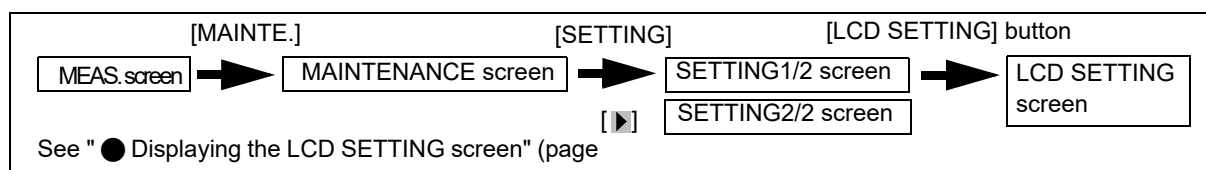

1. Press the BACK LIGHT TIME button on the LCD SETTING screen.

The BACK LIGHT TIME screen is displayed.

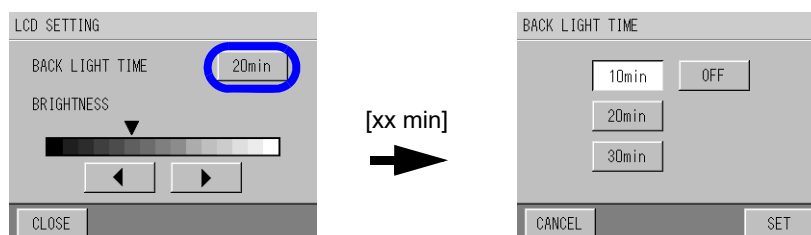

2. Select the items with the button, and press [SET].

Returns to the LCD screen.

5.8.2 Controlling brightness

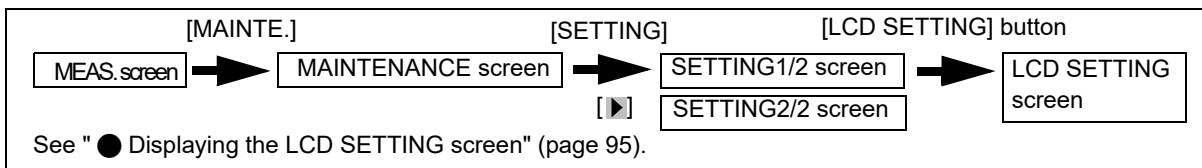

1. Control the brightness using [▶] and [◀] on the LCD SETTING screen.



5.9 Touch Panel Adjustment

Calibrate the screen position when a button other than the one that you pressed reacts, or the screen may act in an unexpected manner.

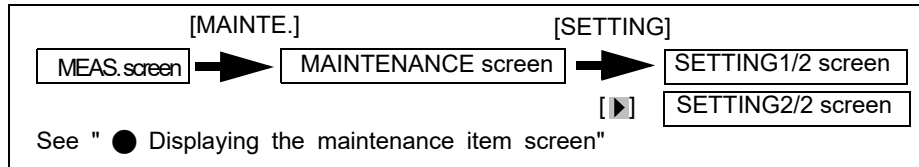

1. Press [TOUCH PANEL ADJUSTMENT] on the SETTING 2/2 screen.

The TOUCH PANEL ADJUSTMENT screen is displayed.



2. Press the locations indicated by the arrow.

Returns to the SETTING screen when the adjustment ends.

5.10 Measurement Settings

The following are available for configuring measurement settings.

Measurement item	Setting	Description	Initial Setting
All Measurement Items	HIGH ALARM (5.14.6, page 123)	See "5.14 Alarm" (page 119).	
	LOW ALARM (5.14.7, page 124)		
	UNIT HIGH ALARM (5.14.8, page 125)		
	UNIT LOW ALARM (5.14.9, page 126)		
	COEFFICIENTS (5.10.1, page 100)	Even after calibration, measured values can deviate from their actual values for a variety of reasons, so the coefficients can help correct these values.	a=0 b=1.000
Turbidity	RANGE (5.10.2, page 101)	Sets the measurement range.	0-10
Color	RANGE (5.10.2, page 101)	Sets the measurement range.	0-20
	TURB. COEFFICIENTS (5.10.3, page 102)	You can correct color when a measurement value deviates from the actual value by using the turbidity.	0.000
Residual chlorine	APPLIED VOLTAGE (5.10.4, page 103)	Specifies the applied voltage.	+50 mV
	RANGE (5.10.5, page 103)	Sets the measurement range.	0-5
Water pressure	UNIT (5.10.6, page 104)	Sets the measurement unit.	MPa
Conductivity (optional)	RANGE (5.10.7, page 104)	Sets the measurement range.	0-1000

● **Displaying the setting screens for each measurement item**

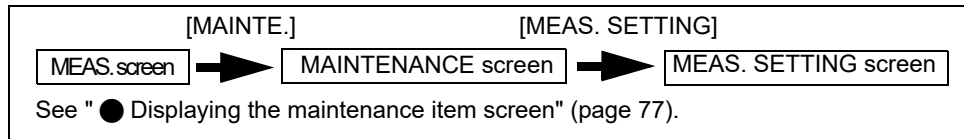

1. Press the button (the following example: [turbidity]) of any of the measurement items on the MEAS.SETTING screen.

The setting screen for the selected measurement item is displayed.

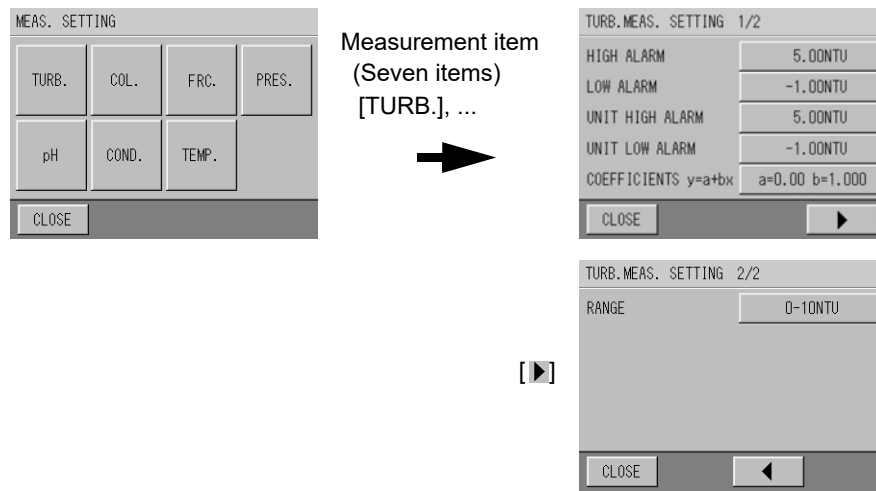

* This example is the TURB. screen.

5.10.1 Setting the COEFFICIENTS

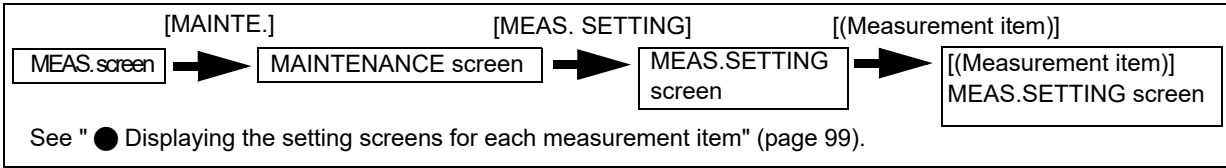

Reference

See "9.8 Evaluating Coefficients" (page 170).

1. Press the COEFFICIENTS $y=a+bx$ button on the TURB. MEAS. SETTING 1/2 screen for each measurement item.

The TURB. COEFFICIENTS screen for all measurement items is displayed.

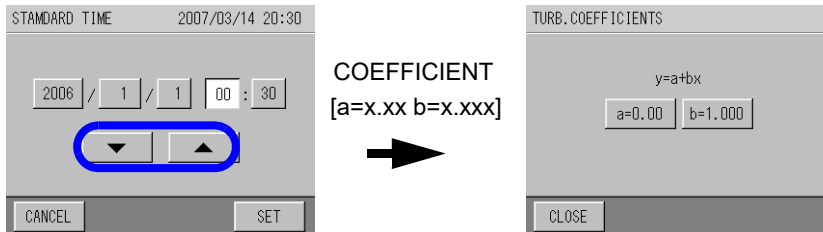

* This example is the TURB. screen.

2. Press [a=x.xx].

The COEFFICIENTS (a) SETTING screen for the appropriate measurement item is displayed.

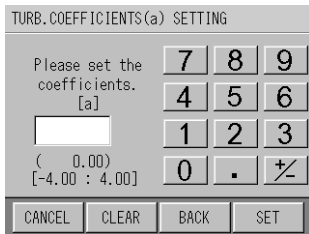

3. Enter the "a" value using the numerical key pad and press [SET].

Measurement item	Input range
Turbidity	-4.00 to 4.00
Color	-20.0 to 20.0
Residual chlorine	-2.00 to 2.00
Water pressure	-1.000 to 1.000
pH	-5.00 to 5.00
Conductivity (optional)	-50.0 to 50.0
Water temperature (optional)	-25.0 to 25.0

Tip

[CLEAR]: Clears the whole value.

[BACK]: Deletes the right-most number of the value.

The screen returns to the COEFFICIENTS (a) SETTING screen for the appropriate measurement item.



4. Press [b=x.xxx].

The COEFFICIENTS (b) SETTING screen for the appropriate measurement item is displayed.

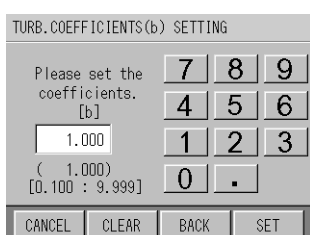

5. Enter the "b" value using the numerical key pad and press [SET].

Measurement item	Input range
All measurement items	0.100 to 9.999

Tip

[CLEAR]: Clears the whole value.

[BACK]: Deletes the rightmost number of the value.

The screen returns to the COEFFICIENTS (a) SETTING screen for the appropriate measurement item.

5.10.2 Setting the range for turbidity and color

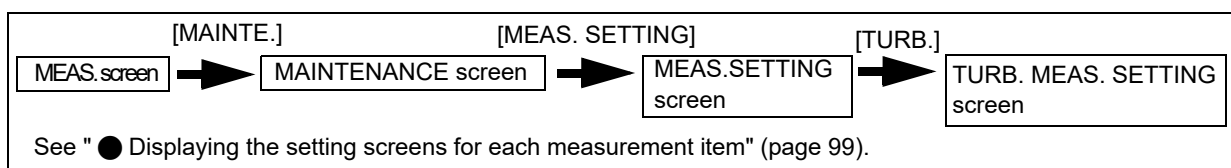

1. Press the RANGE button on the TURB. MEAS. SETTING 1/2 screen.

The TURB. RANGE screen is displayed.

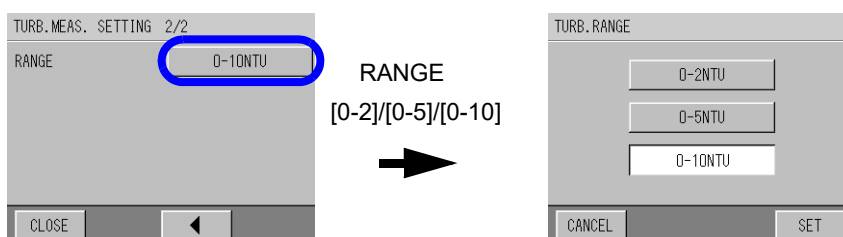

2. Select the button with the desired range, and press [SET].

Returns to the TURB. MEAS. SETTING screen

Set the range for color the same way as for turbidity.

5.10.3 Correcting color using turbidity

This device can automatically correct the effect of turbidity on the color. However, the degree of the effect depends on the calibration solution and sample water, and the measurement value sometimes shifts with sample water. The turbidity coefficient corrects the measurement value.

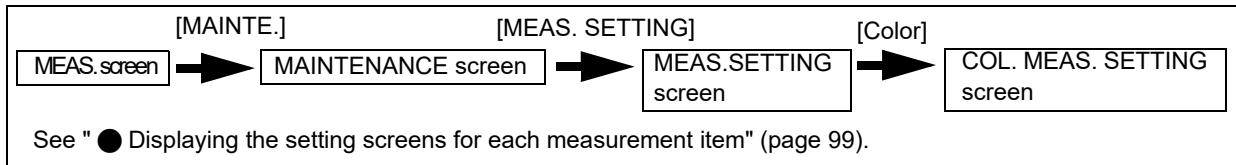

Reference

See "● Evaluating the color turbidity coefficient" (page 166).

1. Press the **TURB. COEFFICIENTS** button on the **COL. MEAS. SETTING 1/2** screen. The **COL. TURB. COEFFICIENTS** screen is displayed.

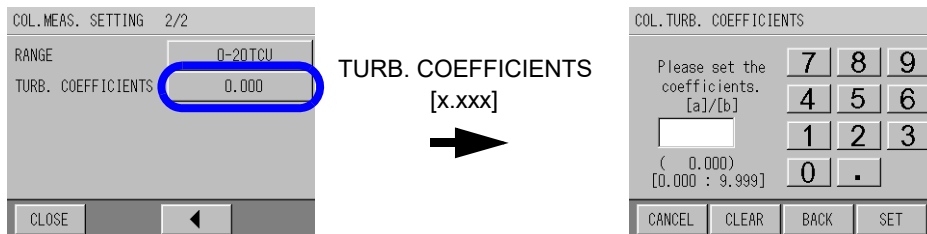

2. Enter the **COEFFICIENTS** value using the numerical key pad and press **[SET]**.
Input range: 0.000 to 9.999

Tip

[CLEAR]: Clears the whole value.

[BACK]: Deletes the rightmost number of the value.

Returns to the **COL. MEAS. SETTING** screen.

5.10.4 Setting the applied voltage for residual chlorine

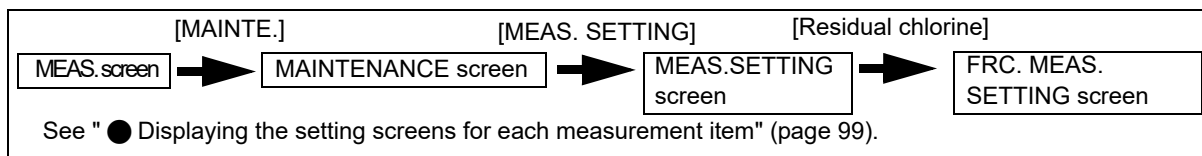

1. Press the **APPLIED VOLTAGE** button on the **FRC. MEAS. SETTING 2/2** screen.
The **FRC. APPLIED VOLTAGE SETTING** screen is displayed.

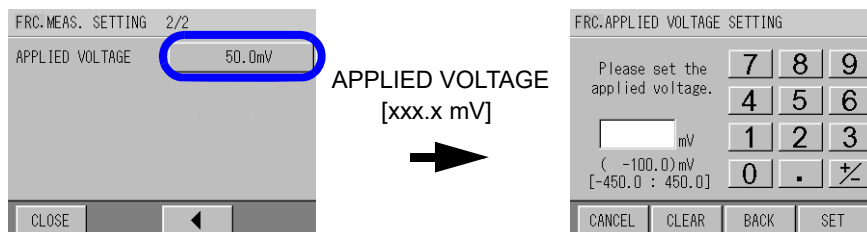

2. Enter the **APPLIED VOLTAGE** value using the numerical key pad and press **[SET]**.
 - Input range: -450.0 mV to 450.0 mV
 - Applied voltage in using residual-chlorine sensor #3440-02C

Working electrode	Applied voltage	Difference
Platinum	+50 mV	Working electrode color: silver



Tip

[CLEAR]: Clears the whole value.

[BACK]: Deletes the rightmost number of the value.

The display returns to the **FRC. MEAS. SETTING** screen.

5.10.5 Setting the range for residual chlorine

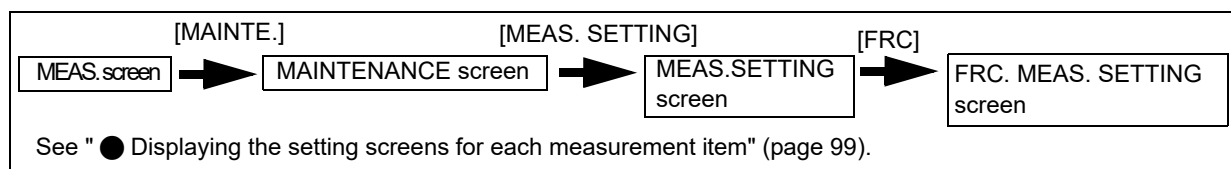

1. Press the RANGE button on the FRC. MEAS. SETTING 2/2 screen.
The FRC. RANGE screen is displayed.

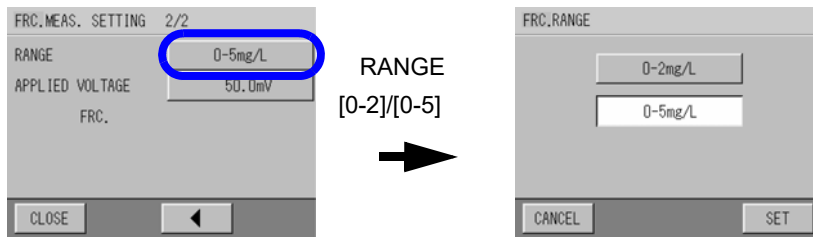

2. Select the button with the desired range, and press [SET].
Returns to the FRC. MEAS. SETTING screen

5.10.6 Setting the unit for water pressure

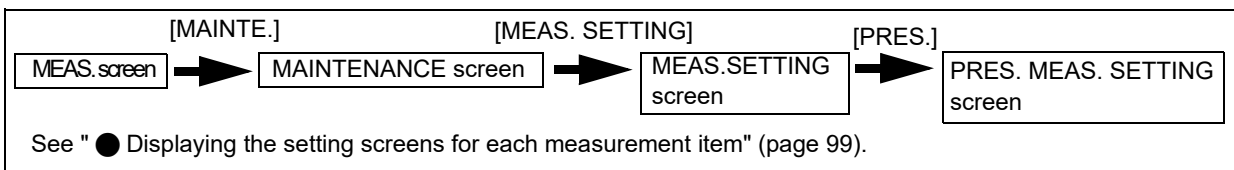

1. Press the RANGE button on the PRES. MEAS. SETTING 2/2 screen.
The PRES. RANGE screen is displayed.

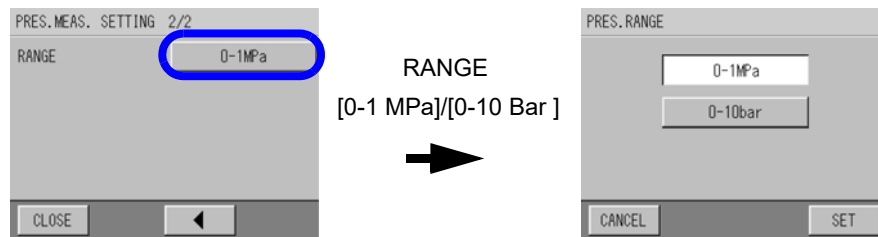

2. Select the button with the desired range, and press [SET].
Returns to the PRES. MEAS. SETTING screen

5.10.7 Setting the range for conductivity (Optional)

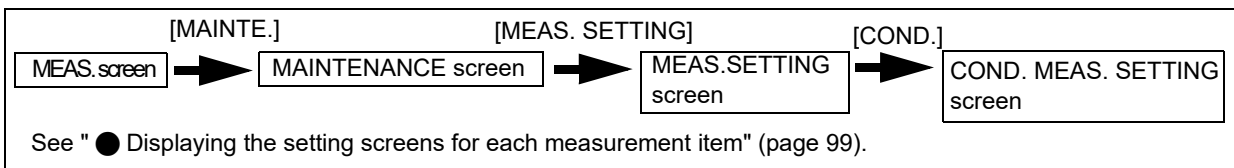

1. Press the RANGE button on the COND. MEAS. SETTING 2/2 screen.
The COND. RANGE screen is displayed.

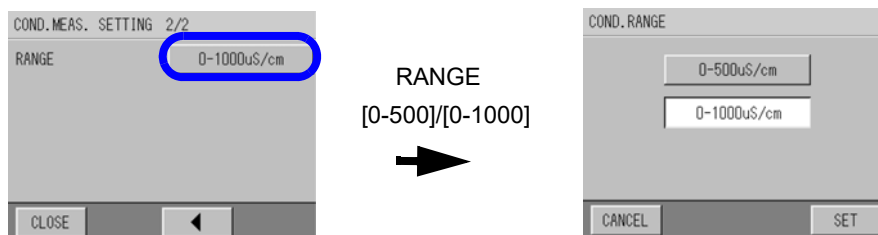

2. Select the button with the desired range, and press [SET].
Returns to the COND. MEAS. SETTING screen

5.11 Action

ACTION operation is a function that allows you execute the following operations by using the buttons on the LCD.

ACTION	Description
AUTO WASHING	Use wiper of the turbidity/color cells to wash the turbidity/color cells.
CHECK ALARM	Check automatically that the turbidity, color and the residual-chlorine sensor display zero when measuring the zero-solution and that the conductivity sensor (optional) drains the water in the cell and displays zero (zero opening). When zeros are not shown, the analyzer-abnormality alarm is activated. This function is used to check the cause of alarm (sensor or sample water) when the alarm for abnormal concentration is activated when measuring sample water.
MEAS.(ZERO)	Measures the zero calibration solution that filtered sample water and checks the measured value of each sensor.
MEAS.(SPAN)	Measures the span calibration solution in the calibration solution tank and checks the measured value of each sensor. You need to connect the calibration solution tank to the calibration inlet of device.
DRAIN	Drains the water from the cell. Perform this when doing maintenance such as a sensor exchange, or when stopping operation.
SAMPLING CHECKING	Obtains sample water from abnormal sample inlet. One a water sampling has been performed, it can not be performed again the function is reset. (See "5.6.3 Perform the SAMPLING RESET" (page 93).) It is necessary to connect the container to obtain a water sampling to the inlet.
AUTO DRAIN	Repeat the drain sequence as specified in "AUTO DRAIN SETTING".

5.11.1 Performing ACTION operation

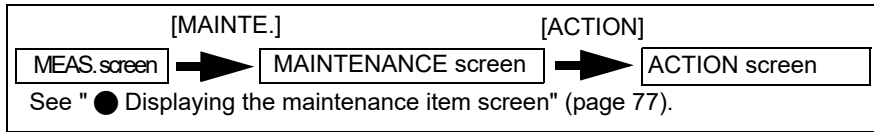

The execution of ACTION operation is described using AUTO WASHING as an example. The execution is same for other items. ACTION executes when you press the button for an item on the ACTION screen.

1. Press the ACTION item to operate on the ACTION screen.

A operation confirmation screen is displayed.

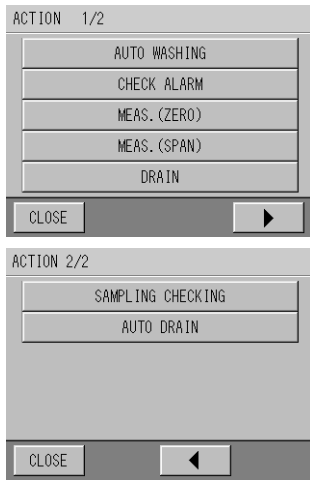

All six items
[AUTO WASHING SETTING], ...

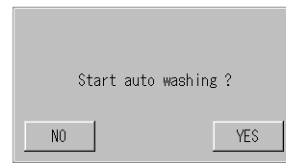

* This example is the screen for AUTO WASHING.

2. Press [YES].

The operation starts, and the operation screen is displayed.

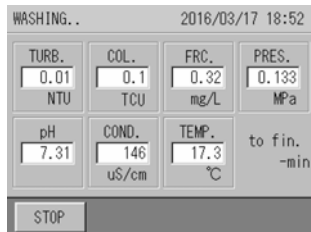

Tip
[STOP]: Stops the operation.

When the operation is completed, the completion window is displayed.

5.12 Checking the Device Status

The following items can be checked.

TEMPERATURE (5.12.1, page 107)	Check the value of each compensation temperature sensor.
UNIT INFORMATION (5.12.2, page 107)	Check the model and ID of the device. The ID number is used when communicating over a serial connection, or in the folder name of data transferred to the CF (CompactFlash) card.
Setting ID (5.12.3, page 108)	Sets the ID to identify each device.
Analog input check (5.12.4, page 109)	Check the value of analog input from each sensor. The value is used as a target.
Analog output check (5.12.5, page 109)	Check the value of analog output.

5.12.1 Displaying the TEMPERATURE screen

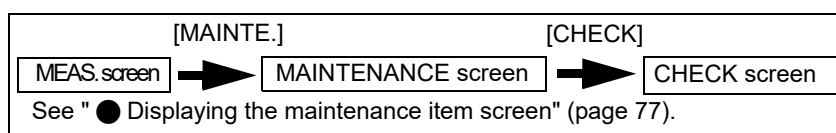

1. Press [TEMPERATURE] on the CHECK screen.

The TEMPERATURE screen is displayed.

The type of the temperature sensor and the temperature is displayed.

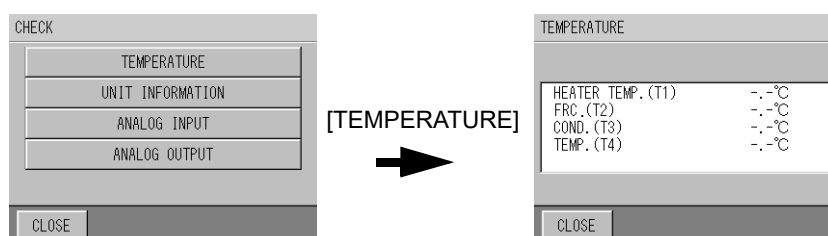

* The temperature sensors for conductivity (T3) and water temperature (T4) are optional.

5.12.2 Displaying the UNIT INFORMATION screen

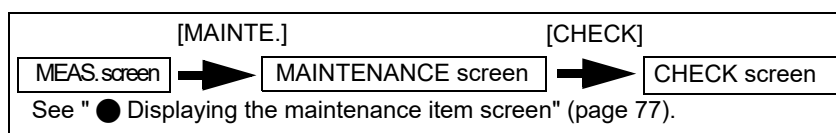

1. Press [UNIT INFORMATION] on the CHECK screen.

The UNIT INFORMATION screen is displayed.

The model number and ID information is displayed.

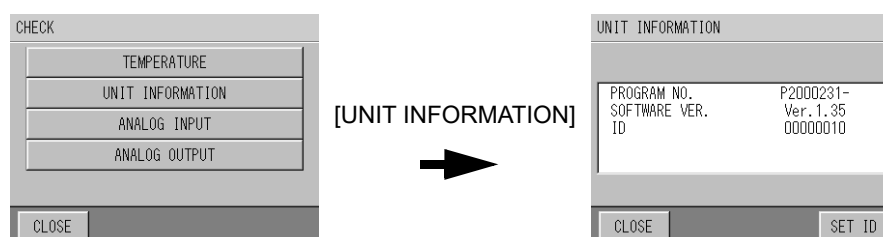

5.12.3 Setting ID

1. Press **[UNIT INFORMATION]** on the **CHECK** screen.

The **UNIT INFORMATION** screen is displayed.

The model number and ID information are displayed.

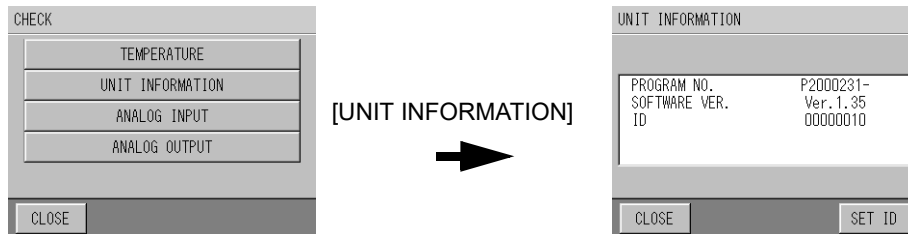

2. Press **[ID]**.

The **ID SETTING** screen is displayed.

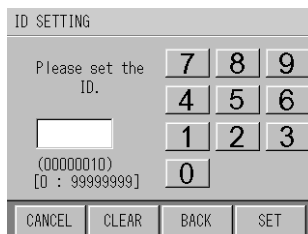

3. Enter the ID number using the numerical key pad and press **[SET]**.

Input range: 0 to 99999999

Tip

[CLEAR]: Clears the whole value.

[BACK]: Deletes the rightmost number of the value.

Returns to the **UNIT INFORMATION** screen.

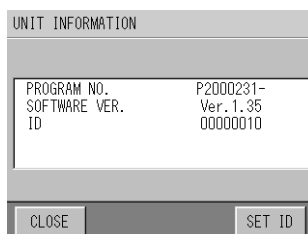

5.12.4 Analog input check

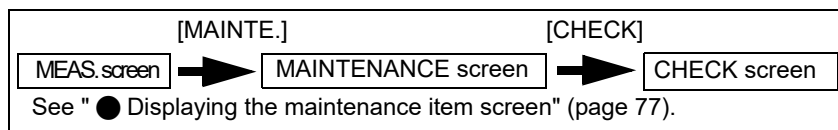

1. Press [ANALOG INPUT] on the CHECK screen.

The ANALOG INPUT screen is displayed.

The value of the analog input from each sensor is displayed.

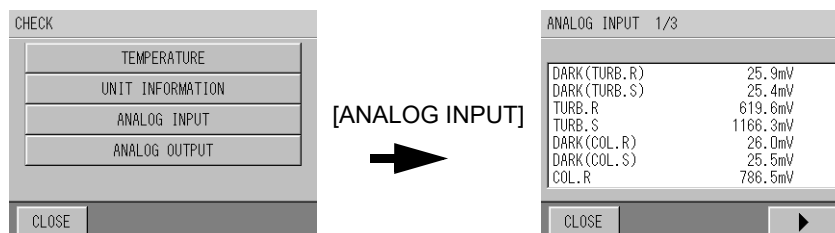

5.12.5 Analog output check

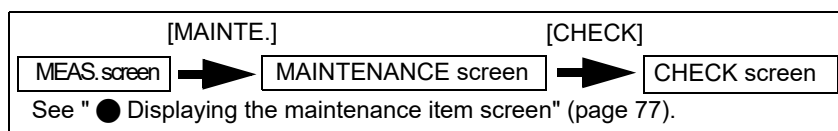

Tip

When there is no operation for 30 minutes ANALOG OUTPUT screen, the display returns to the previous CHECK screen.

1. Press [ANALOG OUTPUT] on the CHECK screen.

The ANALOG OUTPUT screen is displayed.



2. Press the button of the item to output ([x.xxmA]), and change the values with [▲] or [▼], then press [OUTPUT].

Output value: 0.00/4.00/8.00/12.00/16.00/20.00 mA

3. Check the output with an ammeter.

Reference

"6.1 Analog Output" (page 127)

5.13 Data Check

The items for the data check are as follows.

Data check item	Description
DATA HISTORY (5.13.1, page 111)	The past data of the measurement values can be confirmed numerically. Up to about 11 days of minute data (MIN) data can be saved, and up to about 13 months of hourly data (HOUR) can be saved.
Delete data history (5.13.2, page 112)	Deletes the data history.
Display a graph (5.13.3, page 113)	The past data of the measurement values can be checked graphically.
Calibration history check (5.13.4, page 115)	A maximum of 20 records can be checked according to the measurement item or zero/span.
Delete calibration history (5.13.5, page 116)	Deletes the calibration history.
Check alarm history (5.14.3, page 121)	The maximum 511 alarms can be confirmed.
Delete alarm history (5.14.4, page 121)	Deletes the alarm history
Flow rate check (5.13.6, page 117)	Confirm the capacity target of the amount of sample water used by the device.
Transfer data to CF (CompactFlash) card (5.13.7, page 118)	Transfers the data to a CF (CompactFlash) card.
Initialize CF (CompactFlash) card (5.13.8, page 118)	Initializes a CF (CompactFlash) card.

● Displaying Data for an Item

1. Press [DATA] on the MEASUREMENT screen.

The DATA screen is displayed.

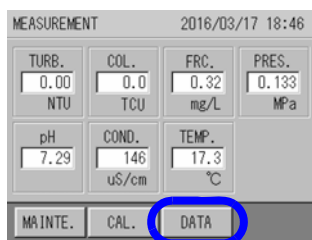

MEASUREMENT screen

[DATA]

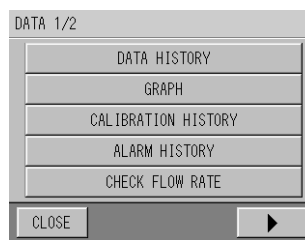

DATA 1/2 screen

[▶]

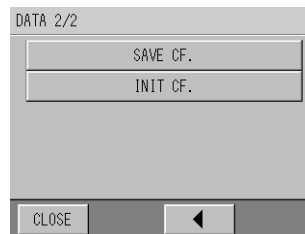

DATA 2/2 screen

5.13.1 Displaying the data history

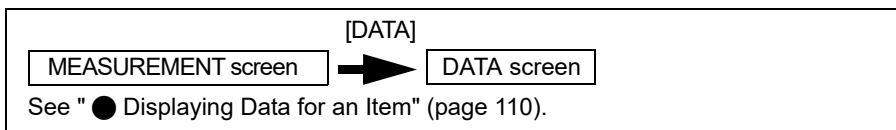

1. Press [DATA HISTORY] on the DATA 1/2 screen.

The DATA HISTORY screen is displayed.

The data history time and measurement value of each item are displayed.

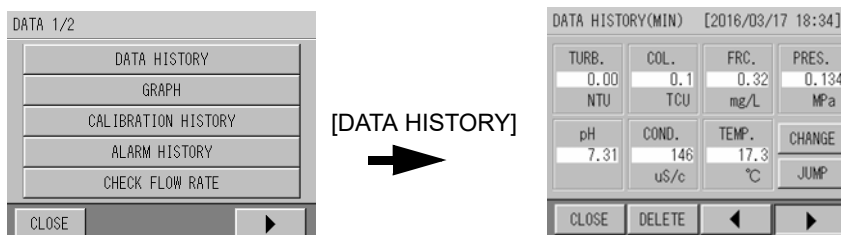

MIN.: Data for when the seconds on the clock were 00. Maximum amount of data:

Approx. 11 days

HOUR.: Data for when the minutes on the clock were 00. Maximum amount of data:

Approx. 13 months

The following mark is displayed in the data during each operation.

When operations overlap, mark 1 has the highest priority, 2 the next highest, and so on.

DATA HISTORY(MIN) [2016/03/09 16:01]	MARK	Description
TURB. 0.00	MAINT	Maintenance
COL. 6.3	WARM	Warming up
FRC. 1.62	SEQ.	ACTION operation
PRES. 0.005	ALARM	Alarm occurred
NTU		
TCU		
mg/L		
MPa		
pH 7.31		
COND. 168		
TEMP. 22.8		
uS/c		
°C		

Tip

[Delete]: Deletes the data history.

[◀] [▶]: Changes the previous or next set of data.

[CHANGE]: Change the DATA HISTORY screen between MIN/HOUR.

[JUMP]: Displays the data at the specified time.

Displaying the data at a specific time

1. Press [JUMP].

The DATA/TIME (MIN/HOUR) screen is displayed.

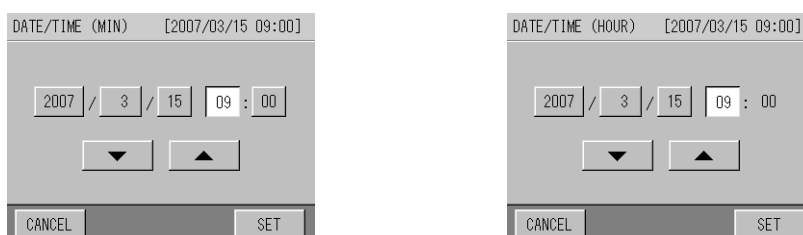

2. Select the button to be changed, and select the numeric number with [▲] or [▼] button. Input the time, then press [SET].

The DATA HISTORY screen that you specified is displayed.

5.13.2 Deleting the data history

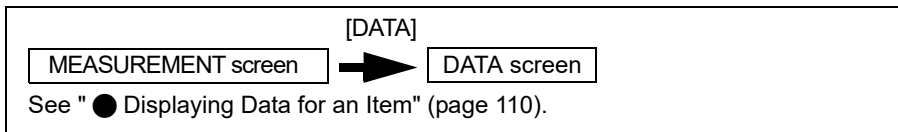

1. Press **[DATA HISTORY]** on the **DATA 1/2** screen.
The DATA HISTORY screen is displayed.



2. Press **[DELETE]**.
A confirmation screen to delete the data is displayed.

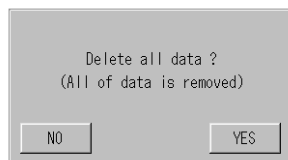

3. Press **[YES]**.
Returns to the DATA HISTORY screen.

Tip

- When deleting the data on the **DATA HISTORY (MIN)** screen:
Deletes all data history of **MIN** value.
- When deleting the data on the **DATA HISTORY (HOUR)** screen:
Deletes all data history of **HOUR** value.

5.13.3 Displaying a graph

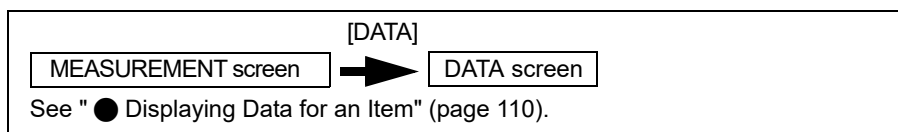

1. Press [GRAPH] on the DATA 1/2 screen.

The GRAPH screen is displayed, and the data history is displayed as a graph.

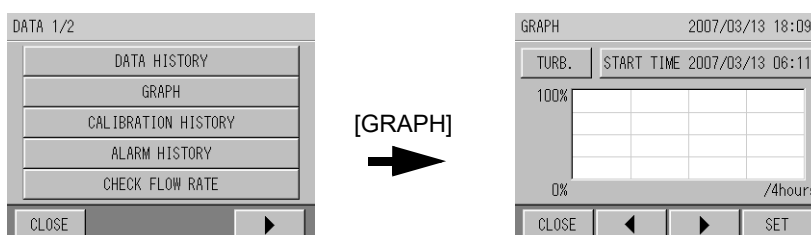

* This example is for the TURB. screen.

Tip

[(Measurement items)]: You can change the measurement items to display.

[START TIME (date and time)]: You can change the start time of the graph.

[◀] [▶]: Displays the previous or next set of data.

[SET]: You can change the range of the vertical and horizontal axes of the graph.

● **Changing the measurement items to display**

1. Press the measurement item ([TURB.]).

The SELECT COMP. screen is displayed.

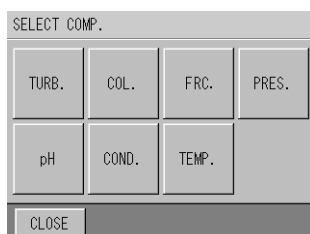

2. Press the measurement item button.

The measurement item is changed.

● **Changing the START TIME SETTING of the graph**

1. Press [START TIME (date and time)].

The START TIME SETTING (MIN/HOUR) screens are displayed.

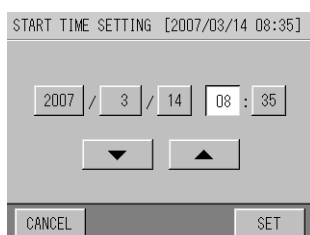

2. Select the button to be changed, and select the numeric number with [▲] or [▼] button. Input the time, then press [SET].

Returns to the GRAPH screen.

● **Changing the range of the vertical axis and horizontal axis of the graph**

1. Press [SET].

The GRAPH SETTING screen is displayed.

GRAPH SETTING			
VERTICAL (HIGH)			
25%	50%	75%	100%
VERTICAL (LOW)			
0%	25%	50%	75%
HORIZONTAL			
4hours	1day	10days	30days
CANCEL			SET

2. Select the range in VERTICAL (HIGH), VERTICAL (LOW) or HORIZONTAL, and press [SET].

VERTICAL (HIGH)/ VERTICAL (LOW)	The value is the percentage of the range of measured values to display.
HORIZONTAL	4 hours and 1 day display MIN. data. 10 days and 30 days display the HOUR data.

5.13.4 Calibration history check

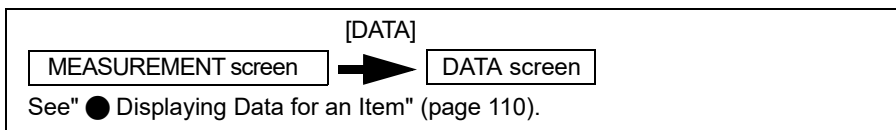

1. Press [CALIBRATION HISTORY] on the DATA 1/2 screen.

The CALIBRATION HISTORY screen is displayed.

Maximum of 20 records of the calibration date or ZERO/SPAN CAL. are displayed in chronologic order by measurement item or zero/span.

Reference

" ● Calibration coefficient" (page 20)

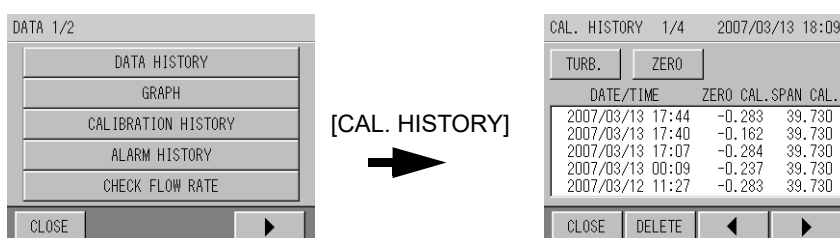

* This example uses the TURB. screen.

[(Measurement items)]: Change the measurement items to display.

[SPAN]/[ZERO]: Change the display of zero calibration history and span calibration history.

[◀] [▶]: Displays the next/previous page.

[Delete]: Deletes the calibration history.

Reference

To change the measurement item to display, see " ● Changing the measurement items to display" (page 113).

5.13.5 Deleting the calibration history

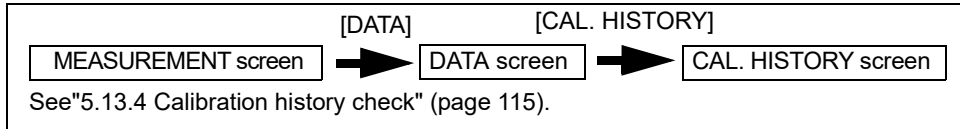

1. Press [DELETE] on the CAL. HISTORY screen.

A confirmation screen to delete the calibration history is displayed.

CAL. HISTORY 1/4		2007/03/13 18:09	
TURB.	ZERO		
DATE/TIME	ZERO CAL.	SPAN CAL.	
2007/03/13 17:44	-0.283	39.730	
2007/03/13 17:40	-0.162	39.730	
2007/03/13 17:07	-0.284	39.730	
2007/03/13 00:09	-0.237	39.730	
2007/03/12 11:27	-0.283	39.730	

CLOSE DELETE ◀ ▶

2. Press [YES].

The screen returns to the CAL. HISTORY screen.

Note

Leaves only the most recent zero/span calibration data, and deletes all of the calibration history before it.

5.13.6 Checking flow rate

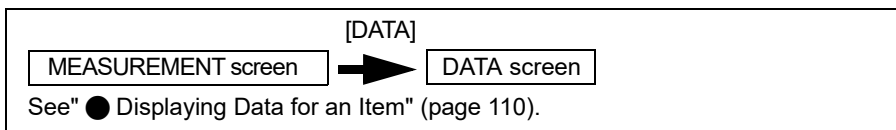

1. Press **[CHECK FLOW RATE]** on the **DATA 1/2** screen.
The **CHECK FLOW RATE** screen is displayed.

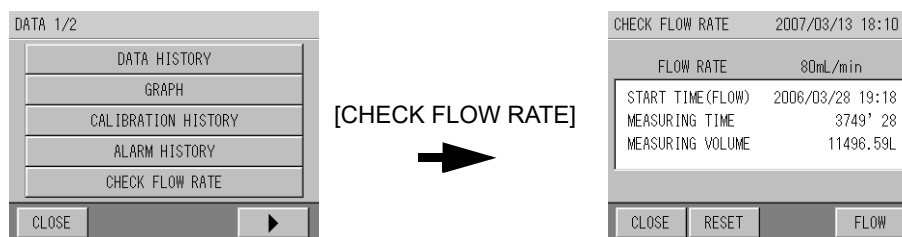

Tip

- [RESET]:** Resets the flow rate.
[FLOW]: Changes the flow rate setting.

● Changing the flow rate setting

1. Press **[FLOW]**.
The **FLOW RATE SETTING** screen is displayed.

The **FLOW RATE SETTING** screen prompts the user to "Please set the flow rate." It features a numerical keypad with digits 0-9 and a decimal point. The current flow rate is displayed as 80 mL/min, with a range of [0 : 200]. At the bottom are buttons for CANCEL, CLEAR, BACK, and SET.

2. Enter the new flow rate value using the numerical key pad and press **[SET]**.
Input range: 0 mL/min to 200 mL/min

Tip

- [CLEAR]:** Clears the whole value.
[BACK]: Deletes the rightmost number of the value.

The screen returns to the maintenance information screen.

5.13.7 Transferring data to a CF (CompactFlash) card

Transfers the data to a CF (CompactFlash) card.

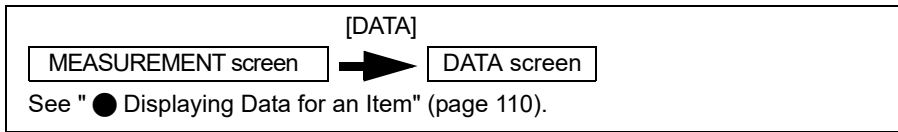

1. Press **[SAVE CF.]** on the **DATA 2/2** screen.

A confirmation screen to copy the data is displayed.

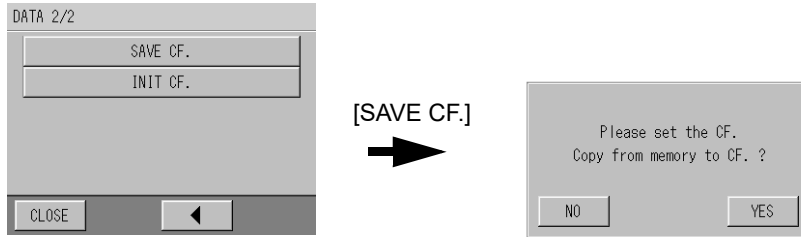

2. Check that the **CF (CompactFlash) card is inserted, and press [YES].**

The copying-data screen is displayed.

The screen returns to the DATA screen when copying is complete.

5.13.8 Initializing a CF (CompactFlash) card

Initializes a CF (CompactFlash) card.

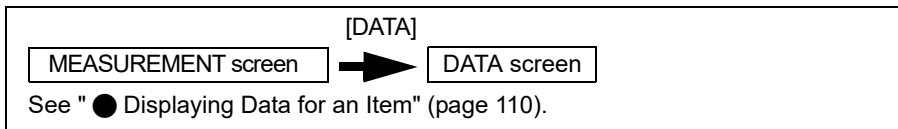

1. Press **[INIT CF.]** on the **DATA 2/2** screen.

A confirmation screen to initialize a CF (CompactFlash) card is displayed.

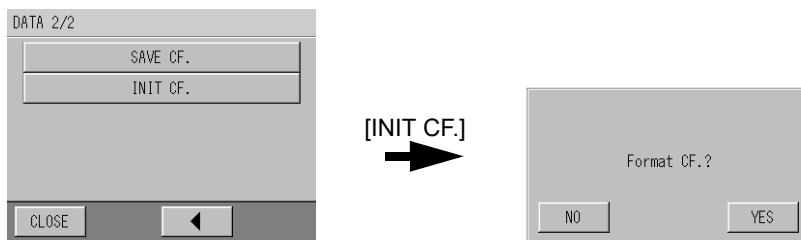

2. Check that the **CF (CompactFlash) card is inserted, and press [YES].**

The screen returns to the DATA screen when initialization is complete.

Note

- Make sure to use the CF (CompactFlash) card supplied with your device. Using another CF (CompactFlash) card may cause damage to your device.
- Initialize the CF (CompactFlash) card using the device.
- The file system of this device is FAT. It does not support FAT32 or NTFS.
- When using multiple devices, set the ID for every device to uniquely identify data. ("5.12.3 Setting ID" (page 108))

5.14 Alarm

You can activate an alarm when exceeding the specified measurement values for each measurement item.

Reference

"8.1 Alarm List" (page 148)

The operations and settings for alarms are as follows.

Item	Description
Checking an alarm (5.14.1, page 120)	You can check the current alarm.
Cancelling an alarm (5.14.2, page 120)	Forcibly cancels an activated alarm.
Checking the alarm history (5.14.3, page 121)	A maximum 511 alarms can be viewed.
Deleting the alarm history (5.14.4, page 121)	Deletes the alarm history.
ALARM TIME (5.14.5, page 122)	An alarm occurs when a specified value is exceeded for more than a specified period of time. Also, an active alarm will be cancelled if the measurement value settles within a specified value for more than a specified period of time. However, when performing the washing and the calibration operation, a counter is reset.
HIGH ALARM (5.14.6, page 123)	When exceeding the specified measurement value for each measurement item, an alarm indicating an abnormal sample water is activated.* (Alarm No. 10, 20, 30, 40, 50, 60, 70)
LOW ALARM (5.14.7, page 124)	When falling short of the specified measurement value for each measurement item, an alarm indicating an abnormal sample water is activated.* (Alarm No. 11, 21, 31, 41, 51, 61, 71)
UNIT HIGH ALARM (5.14.8, page 125)	When exceeding the specified measurement value for each measurement item, an alarm indicating an abnormal device status is activated.* (Alarm No. 12, 22, 32, 42, 52, 62, 72)
UNIT LOW ALARM (5.14.9, page 126)	When falling short of a specified measurement value for each measurement item, an alarm indicating an abnormal device status is activated.* (Alarm No. 13, 23, 33, 43, 53, 63, 73)

*: Since this device rounds measured and specified values down to the significant digits, an alarm may not be activated even if it is displaying a measured value with the value equal to the value specified for the alarm.

5.14.1 Checking an alarm

1. Press **[ALARM]** on the **MEASUREMENT** (main) screen.

The ALARM screen is displayed.

The ALARM VALUE is displayed

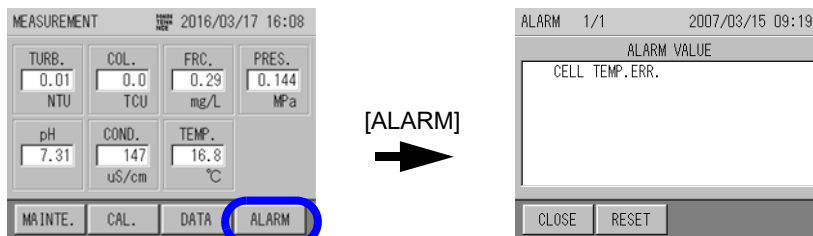

Tip

[RESET]: Resets the active alarm.

5.14.2 Canceling an alarm

1. Press **[ALARM]** on the **MEASUREMENT** (main) screen.

The ALARM screen are displayed.

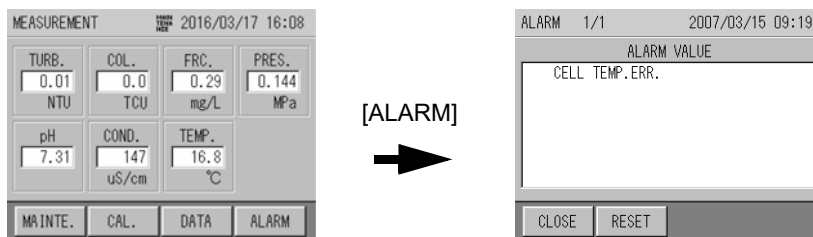

2. Press **[RESET]**.

A confirmation screen to cancel alarm is displayed.



3. Press **[YES]**.

The screen returns to the ALARM screen.

5.14.3 Checking the alarm history

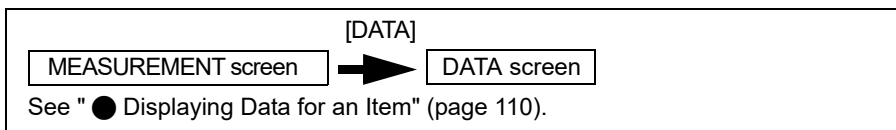

1. Press [ALARM HISTORY] on the DATA 1/2 screen.

The ALARM 1/1 screen is displayed.

ALARM, DATE/TIME, and ON/OFF are displayed.

ON indicates that the alarm is active, and OFF indicates that the alarm has been cancelled.

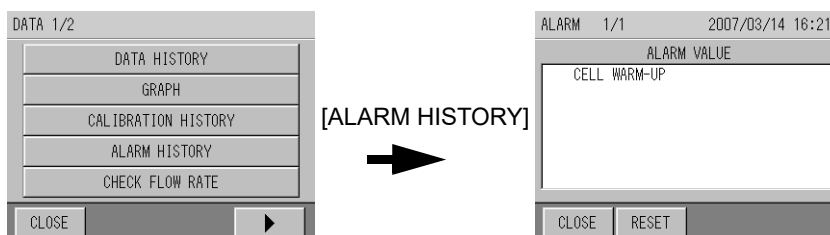

Tip

[DELETE]: Deletes the alarm history.

5.14.4 Deleting the alarm history

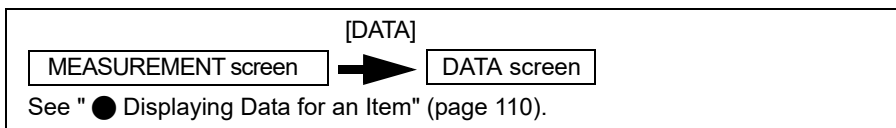

1. Press [ALARM HISTORY] on the DATA 1/2 screen.

The ALARM 1/1 screen is displayed.

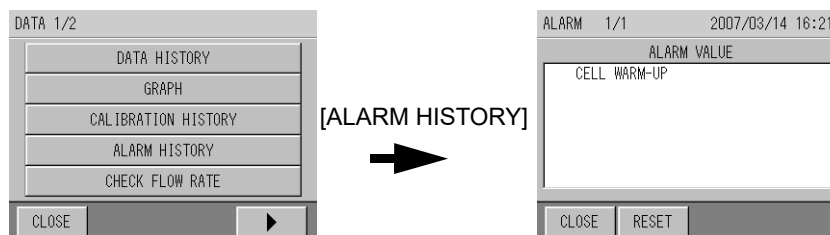

2. Press [DELETE].

A confirmation screen to delete the alarm history is displayed.



3. Press [YES].

The screen returns to the ALARM HISTORY screen.

5.14.5 Setting the ALARM TIME

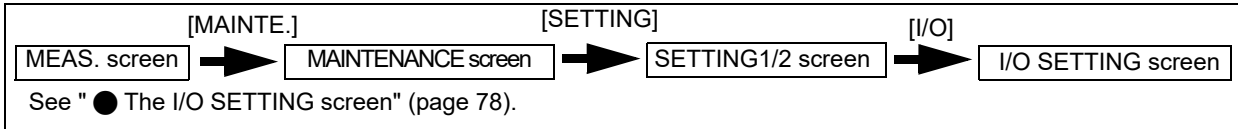

1. Press the ALARM TIME button on the I/O SETTING 2/2 screen.
The ALARM TIME SETTING screen is displayed.

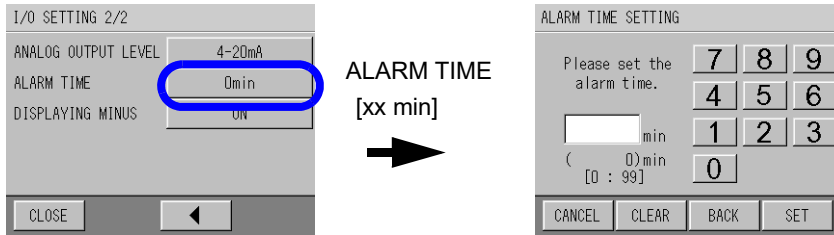

2. Enter the time using the numerical key pad and press [SET].

Input range	Default value	Remarks
0 to 99 (min)	5 (min)	When setting "0", the minimum evaluation time of about 10 seconds is performed.

Tip

- [CLEAR]: Clears the whole value.
- [BACK]: Deletes the rightmost number of the value.

Returns to the I/O SETTING screen.

5.14.6 Setting the HIGH ALARM

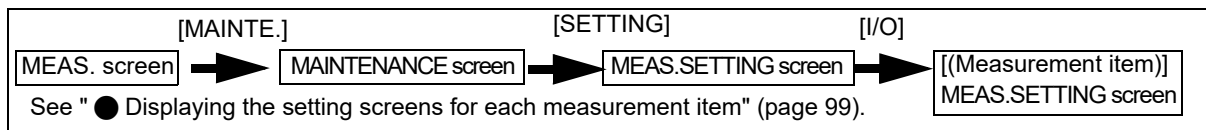

1. For each item to be set, press the button of the item on its MEAS. SETTING screen.

Item to be set on the MEAS. SETTING screen:

TURB., COL., FRC., PRES., pH, COND., TEMP.

The MEAS. SETTING screen of each measurement item is displayed.

2. Press the HIGH ALARM button.

The HIGH ALARM screen is displayed for the appropriate measurement item.

*This example is for the HIGH ALARM SETTING screen of TURB.

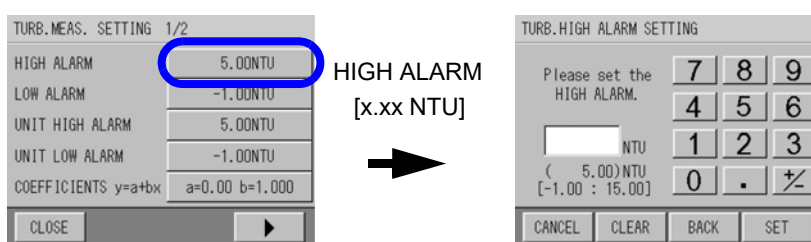

3. Enter the upper limit value using the numerical key pad and press [SET].

Measurement item	Input range (same for each setting)	Default value
Turbidity	-1.00 to 15.00 (NTU)	5.00 (NTU)
Color	-5.0 to 30.0 (TCU)	30.0 (TCU)
Residual chlorine	-1.00 to 7.50 (mg/L)	3.00 (mg/L)
Water pressure	-0.250 to 1.500 (MPa)	1.500 (MPa)
	-2.50 to 15.00 (Bar)	
pH	2.00 to 12.00	12.00
Conductivity (optional)	-100 to 1500 (μS/cm)	750 (μS/cm)
Water temperature (optional)	-10.0 to 100.0 (°C)	100.0 (°C)

Tip

[CLEAR]: Clears the whole value.

[BACK]: Deletes the rightmost number of the value.

The screen returns to the MEAS. SETTING screen for each measurement item.

5.14.7 Setting the LOW ALARM

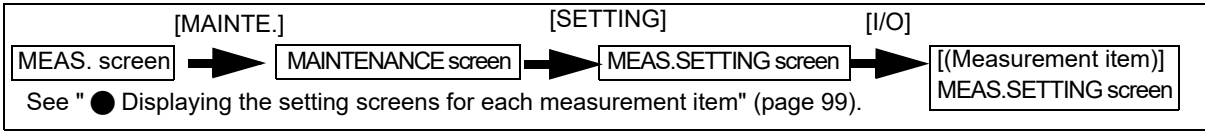

1. For each item to be set, press the button of the item on its MEAS. SETTING screen.
Item to be set on the MEAS. SETTING screen:
TURB., COL., FRC., PRES., pH, COND., TEMP.
2. The MEAS. SETTING screen of each measurement item is displayed.
Press the LOW ALARM button.
*This example is for the LOW ALARM SETTING screen of TURB.

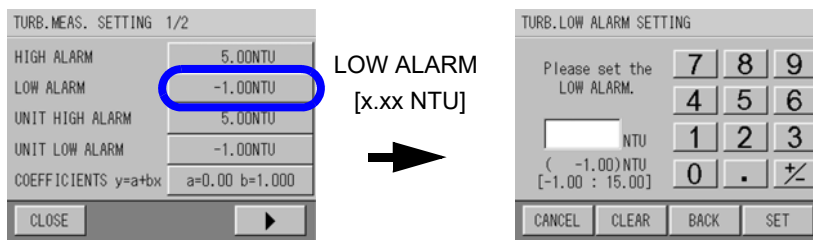

3. Enter the lower limit value using the numerical key pad and press [SET].

Measurement item	Input range (same for each setting value)	Default value
Turbidity	-1.00 to 15.00 (NTU)	-1.00 (NTU)
Color	-5.0 to 30.0 (TCU)	-5.0 (TCU)
Residual chlorine	-1.00 to 7.50 (mg/L)	-1.00 (mg/L)
Water pressure	-0.250 to 1.500 (MPa)	-0.250 (MPa)
	-2.50 to 15.00 (Bar)	
pH (optional)	2.00 to 12.00	2.00
Conductivity (optional)	-100 to 1500 (μS/cm)	-100 (μS/cm)
Water temperature (optional)	-10.0 to 100.0 (°C)	-10.0 (°C)

Tip

- [CLEAR]: Clears the whole value.
- [BACK]: Deletes the rightmost number of the value.

The screen returns to the MEAS. SETTING screen for each measurement item.

5.14.8 Setting the UNIT HIGH ALARM

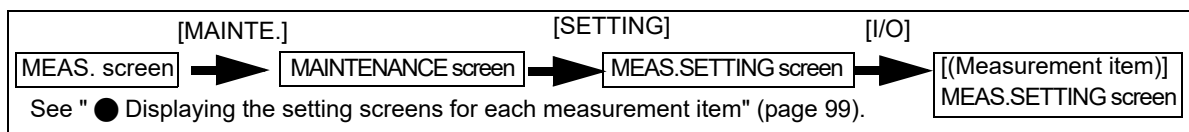

1. For each item to be set, press the button of the item on its MEAS. SETTING screen.

Item to be set on the MEAS. SETTING screen:

TURB., COL., FRC., PRES., pH, COND., TEMP.

The MEAS. SETTING screen of each measurement item is displayed.

2. Press the UNIT HIGH ALARM button.

The UNIT HIGH ALARM screen is displayed for the appropriate measurement item.

* This example is for the UNIT HIGH ALARM SETTING screen of TURB.

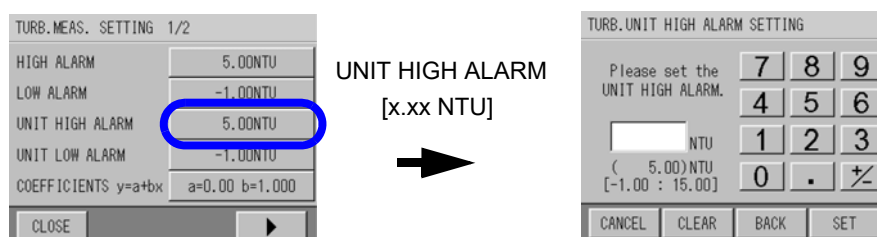

3. Enter the value using the numerical key pad and press [SET].

Measurement item	Input range (same for each setting value)	Default value
Turbidity	-1.00 to 15.00 (NTU)	5.00 (NTU)
Color	-5.0 to 30.0 (TCU)	30.0 (TCU)
Residual chlorine	-1.00 to 7.50 (mg/L)	3.00 (mg/L)
Water pressure	-0.250 to 1.500 (MPa)	1.500 (MPa)
	-2.50 to 15.00 (Bar)	
pH	2.00 to 12.00	12.00
Conductivity (optional)	-100 to 1500 (μS/cm)	750 (μS/cm)
Water temperature (optional)	-10.0 to 100.0 (°C)	100.0 (°C)

Tip

[CLEAR]: Clears the whole value.

[BACK]: Deletes the rightmost number of the value.

The screen returns to the MEAS. SETTING screen for each measurement item.

5.14.9 Setting the UNIT LOW ALARM

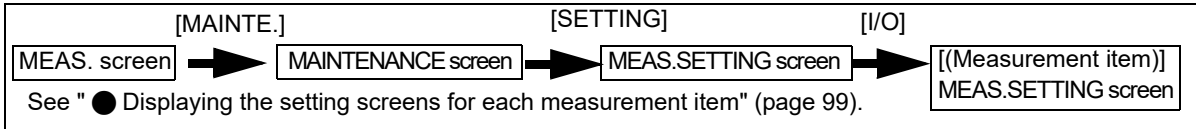

1. For each item to be set, press the button of the item on its MEAS. SETTING screen.
 Item to be set on the MEAS. SETTING screen:
 TURB., COL., FRC., PRES., pH, COND., TEMP.
 The MEAS. SETTING screen of each measurement item is displayed.
2. Press the UNIT LOW ALARM button.
 The UNIT LOW ALARM screen is displayed for the appropriate measurement item.
 * This example for is the UNIT LOW ALARM SETTING screen of TURB.



3. Enter the value using the numerical key pad and press [SET].

Measurement item	Input range (same for each setting value)	Default value
Turbidity	-1.00 to 15.00 (NTU)	-1.00 (NTU)
Color	-5.0 to 30.0 (TCU)	-5.0 (TCU)
Residual chlorine	-1.00 to 7.50 (mg/L)	-1.00 (mg/L)
Water pressure	-0.250 to 1.500 (MPa)	-0.250 (MPa)
	-2.50 to 15.00 (Bar)	
pH	2.00 to 12.00	2.00
Conductivity (optional)	-100 to 1500 (µS/cm)	-100 (µS/cm)
Water temperature (optional)	-10.0 to 100.0 (°C)	-10.0 (°C)

Tip

- [CLEAR]:** Clears the whole value.
- [BACK]:** Deletes the rightmost number of the value.

The screen returns to the MEAS. SETTING screen for each measurement item.

6 INPUT/OUTPUT

This device has interfaces for parallel input/output, analog output and RS-232C input/output on the top of the device.

Use the I/O interfaces when you need to output information like warnings and measurement values, as well as when you need to perform remote operation.

6.1 Analog Output

When outputting to an external device, this device uses an analog current for output.

● Measurement items and analog output range, 4 mA to 20 mA

Measurement item	Range	4 mA output	20 mA output
Turbidity	0 to 2 NTU	0.00 NTU	2.00 NTU
	0 to 5 NTU	0.00 NTU	5.00 NTU
	0 to 10 NTU	0.00 NTU	10.00 NTU
Color	0 to 10 TCU	0.0 TCU	10.0 TCU
	0 to 20 TCU	0.0 TCU	20.0 TCU
Residual chlorine	0 to 2 mg/L	0.00 mg/L	2.00 mg/L
	0 to 5 mg/L	0.00 mg/L	5.00 mg/L
Water pressure	0 to 1 MPa	0.000 MPa	1.000 MPa
	0 to 10 Bar	0 Bar	10 Bar
pH	pH 2 to pH 12	pH 2.00	pH 12.00
Conductivity (optional)	0 to 500 μ S/cm	0 μ S/cm	500 μ S/cm
	0 to 1000 μ S/cm	0 μ S/cm	1000 μ S/cm
Water temperature (optional)	0 to 50°C	0.0°C	50.0°C

● Measurement items and analog output range, 0 mA to 16 mA

Measurement item	Range	0 mA output	16 mA output
Turbidity	0 to 2 NTU	0.00 NTU	2.00 NTU
	0 to 5 NTU	0.00 NTU	5.00 NTU
	0 to 10 NTU	0.00 NTU	10.00 NTU
Color	0 to 10 TCU	0.0 TCU	10.0 TCU
	0 to 20 TCU	0.0 TCU	20.0 TCU
Residual chlorine	0 to 2 mg/L	0.00 mg/L	2.00 mg/L
	0 to 5 mg/L	0.00 mg/L	5.00 mg/L
Water pressure	0 to 1 MPa	0.000 MPa	1.000 MPa
	0 to 10 Bar	0 Bar	10 Bar
pH	pH 2 to pH 12	pH 2.00	pH 12.00
Conductivity (optional)	0 to 500 μ S/cm	0 μ S/cm	500 μ S/cm
	0 to 1000 μ S/cm	0 μ S/cm	1000 μ S/cm
Water temperature (optional)	0 to 50°C	0.0°C	50.0°C

The mapping of terminals to measured values for analog output is as follows.

Terminal No.	Signal name
17	+] 1.1 (Turbidity)
18	-]
19	+] 1.2 (Chromaticity)
20	-]
21	+] 1.3 (Residual chlorine)
22	-]
23	+] 1.4 (Water pressure)
24	-]
25	+] 1.5 (pH)*
26	-]
27	+] 1.6 (Electrical conductivity)*
28	-]
29	+] 1.7 (Water temperature)*
30	-]
31	+] 1.8 (Unused)
32	-]

The specification for the analog-current output is as follows.

Signal classification	Input/output circuit	Specifications
Analog Signal Output		<ul style="list-style-type: none"> ● 4 mA to 20 mA DC, Current signal output ● Galvanically separated (COM common) ● Load resistance Max. 600 Ω

Note

Since pH, conductivity and water temperature are optional, only measurements for installed components are output.

6.2 Parallel Input/Output

6.2.1 Parallel output

This device contains the following outputs for the parallel interface.

Item	Terminal No.	Description	Output timing
Power failure	1, 2	Notifies of a power failure.	Signal ON when power is cut (closed circuit) Signal OFF when canceling the power failure (open circuit)
Maintenance	3, 4	Notifies that the device is in maintenance (maintenance mode or calibration mode).	Signal ON when in maintenance mode or calibration mode (closed circuit) Signal OFF when not in maintenance mode or calibration mode (open circuit)
Batch alarm	5, 6	Notifies of any alarm occurrence other than the power failure.	Signal ON when an alarm other than a power failure occurs (closed circuit) Signal OFF when there are no alarm conditions other than a power failure (open circuit)

The mapping of terminals to measured values for the parallel lines is as follows.

Terminal No.	Signal name
1	+] OUT-1 (Power failure)
2	-]]
3	+] OUT-2 (Maintenance)
4	-]]
5	+] OUT-3 (Batch alarm)
6	-]]
7	+] OUT-4 (Unused)
8	-]]

The parallel output specifications are as follows.

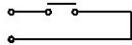
Signal classification	Input/output circuit	Specification
Parallel Signal Output		<ul style="list-style-type: none"> ● Contact rating 125 V AC 0.3 A 30 V DC 1 A ● a contact output

Note

- Do not load the device beyond the maximum rating. Doing so will cause malfunctions.
- Use a spark killer, surge absorber (AC or DC load), or diode (DC load) when opening or closing the load to prevent electrical noise when connecting in parallel.
- A contact output: Normal OFF (open circuit), operating ON (closed circuit)

6.2.2 Parallel input

This device contains the following inputs for the parallel interface. After you enable outside input operation (See "5.2.1 Setting EXT I/O IN" (page 79)), the following operations can be controlled with the inputs.

Item	Terminal No.	Description	Input timing
Start cleaning	9 (+) 13 (-)	Starts cleaning	Starts operating 3 to 10 seconds after switching from OFF (open circuit) to ON (closed circuit).
Zero Calibration Start	10 (+) 13 (-)	Starts the common zero calibration.	Starts operating 3 to 10 seconds after switching from OFF (open circuit) to ON (closed circuit).
ALARM CHECK SETTING Start	11 (+) 13 (-)	Starts ALARM CHECK SETTING.	Starts operating 3 to 10 seconds after switching from OFF (open circuit) to ON (closed circuit).
SAMPLING START	12 (+) 13 (-)	Starts SAMPLING.	Starts operating 3 to 10 seconds after switching from OFF (open circuit) to ON (closed circuit).

The mapping of terminals to measured values for the parallel lines is as follows.

Terminal No.	Signal name
9	+ IN-1 (Cleaning start)
10	+ IN-2 (Zero calibration start)
11	+ IN-3 (Check alarm)
12	+ IN-4 (Sampling start)
13	- IN-COM

The parallel-input specification is as follows.

Signal classification	Input/output circuit	Specification
Parallel Signal Input		<ul style="list-style-type: none"> • No-voltage, a contact signal input (possible to use open collector.) • Insulated input, (-) side commonality. • ON resistance: Max. 100 Ω • Open voltage: 24 V DC • Closed circuit current: Max. 600 Ω

Note

- Do not connect a live contact to the input terminal. Doing so will cause malfunctions.
- For each operating action, see "5.11 Action" (page 105).
- When multiple signals are sent at the same time, the inputs are given the following priority: (1) Cleaning (2) Alarm check setting (3) Zero calibration (4) SAMPLING START. Any other inputs entered at the same time are reserved.
- Parallel inputs that are signaled for fewer than 3 seconds may not be registered by the device. Make sure that an ON signal is sent for at least 3 seconds to guarantee proper operation.

6.3 Serial Input/Output (RS-232C)

This device includes an RS-232C input/output as a standard feature.

The specifications are as follows.

For details on items such as commands, contact HORIBA Advanced Techno.

● JIS-C6361 Conformity

● Transmission format

Baud rate: 19200 bps

Character length: 8 bit

Parity: None

Stop bit: 1 bit

Communication method: Full duplex

● Terminal type

There are the following two terminal types. Make sure to use only one type of terminal.
(You can not use two terminals at the same time.)

- When using a terminal, the terminal assignments are as follows.

Terminal No.	Signal name
14	TxD
15	RxD
16	SG

- A transmission unit connector is used for connecting using the transmission unit option.

Note

You can not use a terminal and a connector for an interface unit at the same time. Use either a terminal or a connector.

● Cable specification

Device side (D-SUB 9 pin female connector)

PC (D-SUB 9 pin female connector)

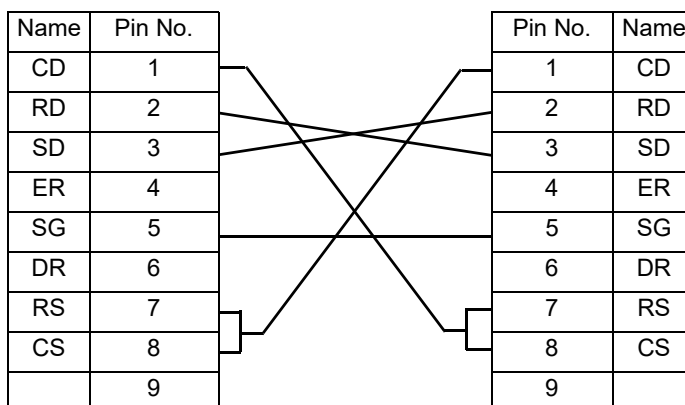

6.4 Storing the Data on a CF (CompactFlash) Card

This device supports data transfer using a CF (compact flash) card. You can save internal data and transfer it to your PC and other devices. Use the provided CF (CompactFlash) card.

Note

The device supports the FAT file system. It does not support FAT32 or NTFS.

- **How to store the data on a CF (CompactFlash) card**

Reference

"5.13.7 Transferring data to a CF (CompactFlash) card" (page 118)

"5.13.8 Initializing a CF (CompactFlash) card" (page 118)

- **Folder structure for a CF (CompactFlash) card**

The name of the root folder is a unique ID. Within the root folder, new folders are created and named for the date on which data was transferred to the CF (CompactFlash) card.

Example

If the ID number is "12345678", and data was transferred on Oct. 22, 2004, 18:00 and on June 7th, 2005, 1:00



- **Folder Contents (saved data)**

Data is saved using the following file names in the new folder.

- One hour data history HDATA.CSV
- One minute data history: MDATA.CSV
- Alarm history: ALMDATA.CSV
- Zero-calibration history: ZERO.CSV
- Span-calibration history: SPAN.CSV

All the above data are saved to the CF (CompactFlash) card at one time.

- **Data file contents**

All files are saved in CSV format. The 1st line of a file contains the labels for the data. Labels have the following meanings:

(HDATA.CSV)

YY/MM/DD/HH:MM;SS	Year/Month/Day/ Hour: Minute: Second
TURB	Turbidity
COLOR	Color
FRC	Residual chlorine
PRESS	Water pressure
PH	pH
COND	Conductivity
TEMP	Water temperature
DataStat	Data status (bit-mapped) *1
AlmTURB	Turbidity data alarm (bit-mapped) *2
AlmCOLOR	Color data alarm (bit-mapped) *2

AlmFRC	Residual chlorine data alarm (bit-mapped) *2
AlmPRESS	Water pressure data alarm (bit-mapped) *2
AlmPH	pH data alarm (bit-mapped) *2
AlmCOND	Water temperature data alarm (bit-mapped) *2
AlmTEMP	Water temperature data alarm (bit-mapped) *2

The data is given in hexadecimal. Replace a hexadecimal digit with its binary-coded form according to the following table. Compare each digit (bit) to the corresponding location in the table from the left. 1 is ON and 0 is OFF.

Conversion table (hexadecimal to binary)

Hexadecimal number	0	1	2	3	4	5	6	7	8	9	A	B	C	D	E	F
Binary digit	0000	0001	0010	0011	0100	0101	0110	0111	1000	1001	1010	1011	1100	1101	1110	1111

*1: Data status

Bit	31	30	29	28	27	26	25	24	23	22	21	20	19	18	17	16	15	14	13	12	11	10	9	8	7	6	5	4	3	2	1	0
	(Spare)	(Spare)	(Spare)	(Spare)	(Spare)	Alarm10 (Cell temperature adjustment abnormality)	Alarm09 (Cell temperature adjustment abnormality)	Alarm08 (Battery alarm)	Alarm07 (Power ON alarm)	Alarm06 (PI0 communication abnormality)	Alarm05 (Leak)	Alarm04 (ADC communication abnormality)	Alarm03 (Cell wiper operation abnormality)	Alarm02 (Sensor temperature compensation abnormality)	Alarm01 (Cell temperature adjustment warning up)	Alarm00 (Cell temperature adjustment abnormality)	(Spare)	(Spare)	(Spare)	(Spare)	(Spare)	(Spare)	(Spare)	(Spare)	Output on hold	Initializing ADC board	Alarm checking	Calibrating	Washing	Power failure	Maintenance	Invalid data

Example) If "DataStat" is "0080000A"

1. Replace a hexadecimal number to a binary-coded form.

Replace each digit as follows: 0 → 0000, 0 → 0000, 8 → 1000,..... 0080000A will be "0000/0000/1000/0000/0000/0000/0000/1010".

2. Assign each binary digit in the Bit table of data status from the left.

Bit	31	30	29	28	27	26	25	24	23	22	21	20	19	18	17	16	15	14	13	12	11	10	9	8	7	6	5	4	3	2	1	0
Binary value	0	0	0	0	0	0	0	0	1	0	0	0	0	0	0	0	0	0	0	0	0	0	0	0	0	0	0	0	1	0	1	0

"1" in binary digit is understood to mean "ON".

Bit 23: Alarm 07 (Power ON alarm)

Bit 3: Washing

Bit 1: Maintenance

*2: Data alarm
Convert the data as in *1.

Bit	15	14	13	12	11	10	9	8	7	6	5	4	3	2	1	0
	Alarm output data	Sequence output data	Warm-up output data	Maintenance output data	(Spare)	(Spare)	(Spare)	(Spare)	Alarm n7 (Analyzer abnormality)	Alarm n6 (Span calibration abnormality)	Alarm n5 (Zero calibration abnormality)	Alarm n4 (Light source abnormality)	Alarm n3 (Concentration device lower limit)	Alarm n2 (Concentration device upper limit)	Alarm n1 (Concentration lower limit)	Alarm n0 (Concentration upper limit)

(MDATA.CSV)

Same as HDATA.CSV.

(ALMDATA.CSV)

YY/MM/DD/HH:MM:SS	Year/Month/Day/ Hour: Minute: Second
AlmNo	Alarm No.
DataStat	Alarm Status ON: 1 OFF: 0

(ZERO.CSV)

- [TURB]: Turbidity data
- [COLOR]: Color data
- [FRC]: Residual chlorine data
- [PRESS]: Water pressure data
- [PH]: pH data
- [COND]: Conductivity data
- [TEMP]: Water temperature data

YY/MM/DD/HH:MM:SS	Year/Month/Day/ Hour: Minute: Second
CalbNo	Calibration number (M: Manual calibration, A: Automatic calibration)
CalbStat	The result of the calibration OK : 0 Fail : 1
CalbConc	Calibration value
CoeffiZero	Zero calibration coefficient
CoeffiSpan	Span calibration coefficient

- **(SPAN.CSV)**
Same as ZERO.CSV.

Note

If files and folders of same name exists, they are overwritten.

7 MAINTENANCE

Perform calibration and regular checks of this device to maintain normal operation and performance.

For calibration of this device, see "4 CALIBRATION" (page 17).

7.1 Maintenance Items

Maintenance item		Maintenance cycle				When to clean/replace
Applicable Sensors	Description	3 months	6 months	Yearly	As needed	
–	Adjustment of flow 80 mL/min				○	–
–	Mesh filter replacement	○				When dirty, After the 3-month calibration
–	Replace the filter cartridge of the zero water filter			○		When dirty
Residual-chlorine Sensors	Polish the residual-chlorine sensor		○			When dirty, When measurement value is unusual
	Replace beads			○		When dirty
	Replace the residual-chlorine sensor				○	When the calibration alarm is activated, When measurement value is unusual
	Replace both meshes of bottom (beads support) and top (for beads trap) in residual-chlorine cell	○				
Conductivity sensor (optional)	Replace the conductivity sensor				○	When the calibration alarm is activated, When measurement value is unusual
pH sensor	Replace the pH sensor		○			When the calibration alarm is activated, When measurement value is unusual

The maintenance cycle in the table is shown when using the device in the normal operating conditions. Depending on the operating conditions, the optimum maintenance cycle may be different; observe the condition of the device after operating for a while and adjust the maintenance cycle accordingly.

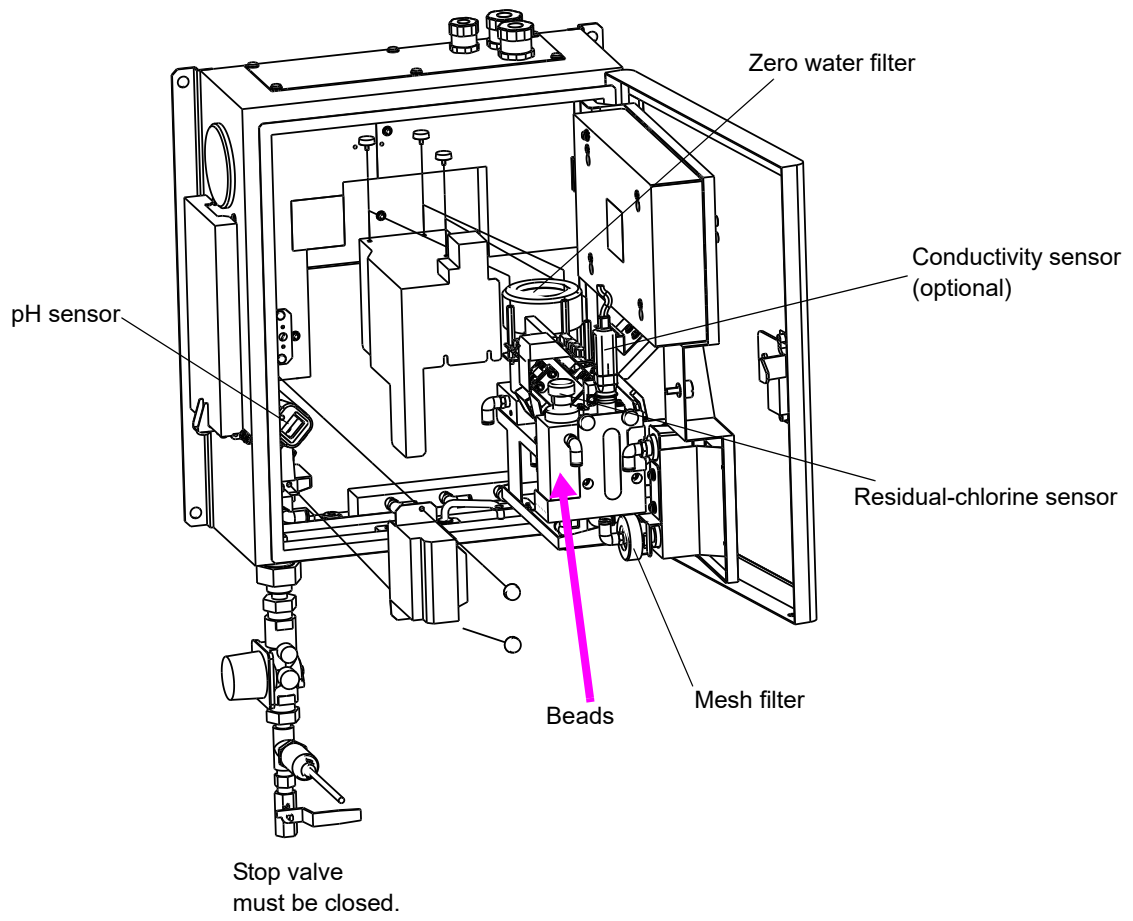

7.2 Stopping and Restarting Operation

● Stopping operation

1. Close the stop valve.

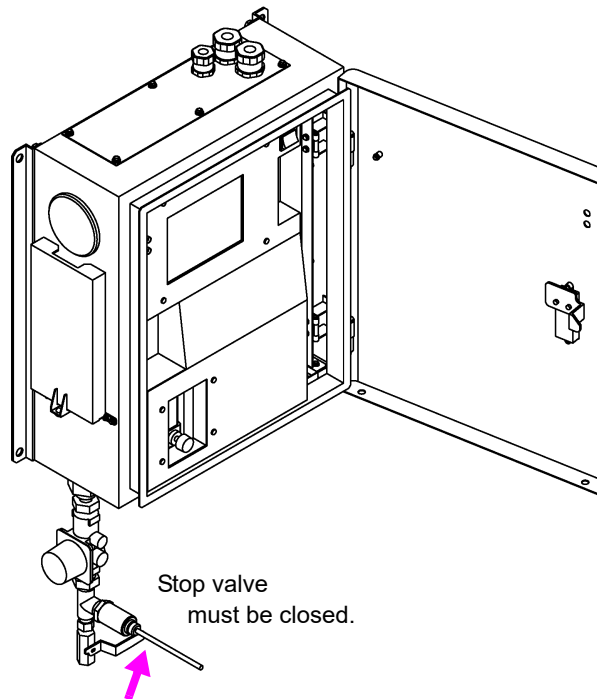

2. Start the action for the water discharge operation.

Reference

"5.11 Action" (page 105)

Tip

If water is not discharged properly, run sample water again and repeat the procedure from step .

3. Turn off the power.
4. Open the inner door of the device.

Reference

"2.1 Opening the Inner Door of the Device" (page 7)

● Restarting operation

1. Close the inner door of the device.
2. Operation starts.

Reference

"3.1 Starting the Device" (page 11)

7.3 Connection Locations for the Sensor Connectors

The following figure shows the location of the sensor connectors.

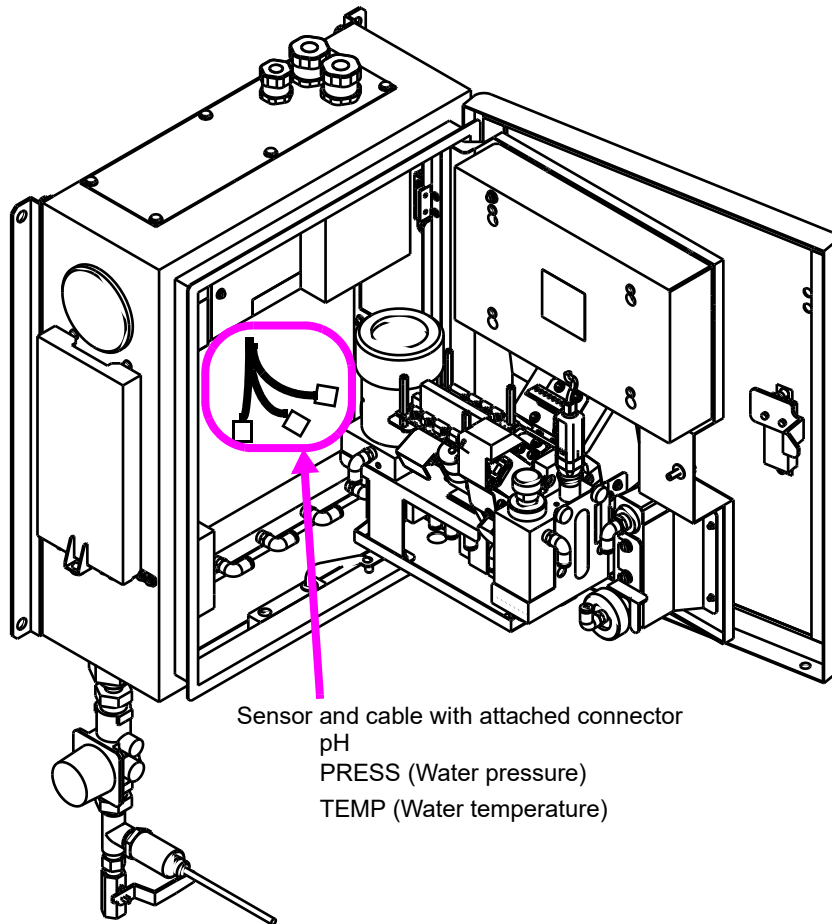

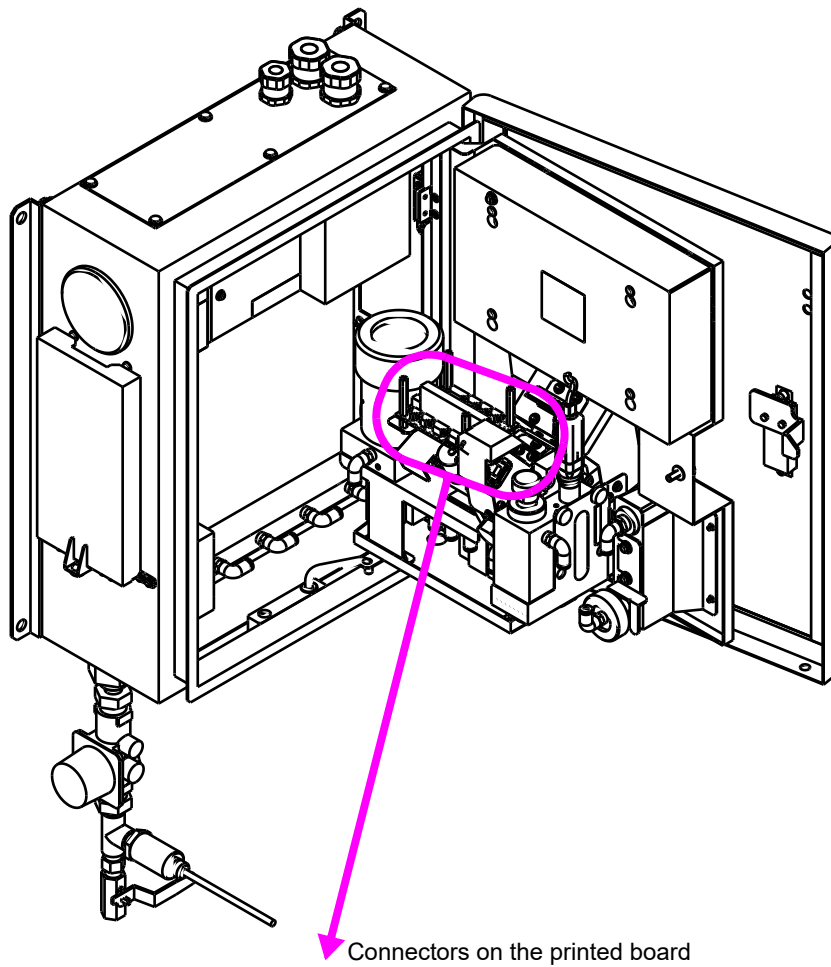

Connectors on the printed board

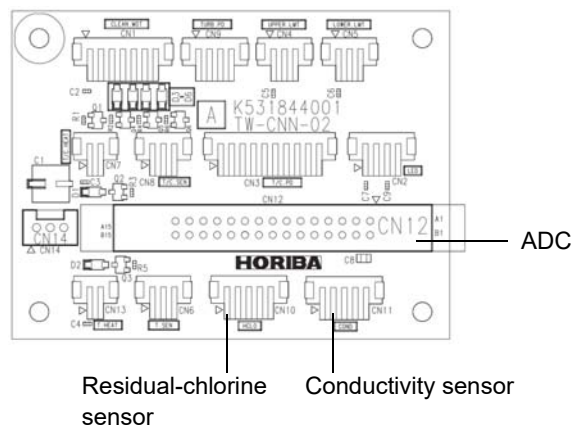

7.4 Parts Maintenance and Replacement

7.4.1 Replacing the mesh filter

1. Make sure that the stop valve is closed, and the sample water is being discharged.

Reference

"● Stopping operation" (page 137)

2. Remove the filter cap.

You do not have to remove the tubes.

3. Remove the filter stopper.

Hold a cloth under the filter holder, as water will run from the filter holder, and the filter support may also fall.

4. Pull out the mesh filter inside the filter holder and filter support.

5. Wipe any dirt off of the filter stopper with a lint-free cloth, or rinse with tap water.

6. Replace with a new mesh filter and reassemble the unit.

The direction in which you install the mesh filter and filter support is not important.

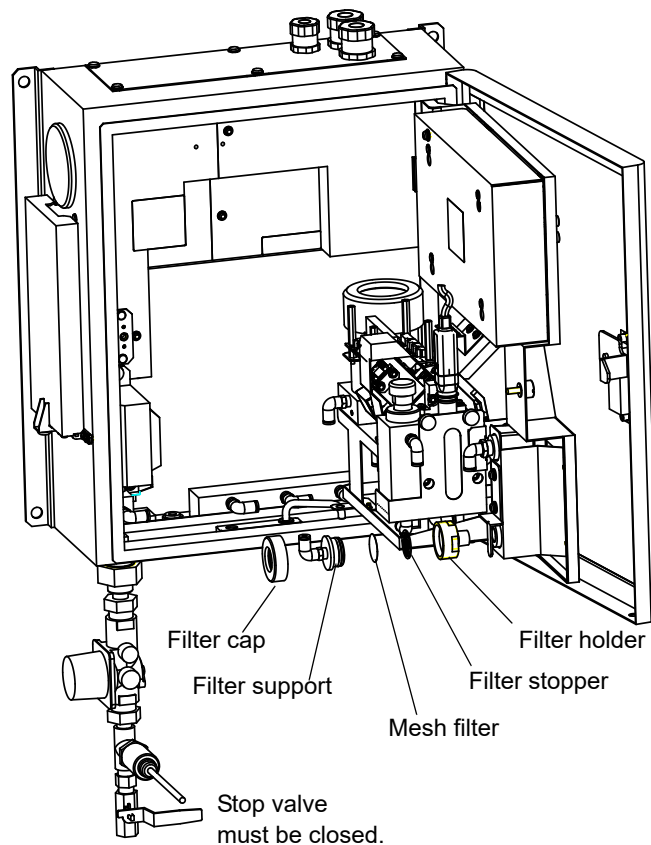

7.4.2 Replacing the filter cartridge of the zero water filter

1. Unscrew the cover of the zero water filter, and remove the filter cartridge.

Water will drip from the filter cartridge when you remove it; use a cloth to catch the water.

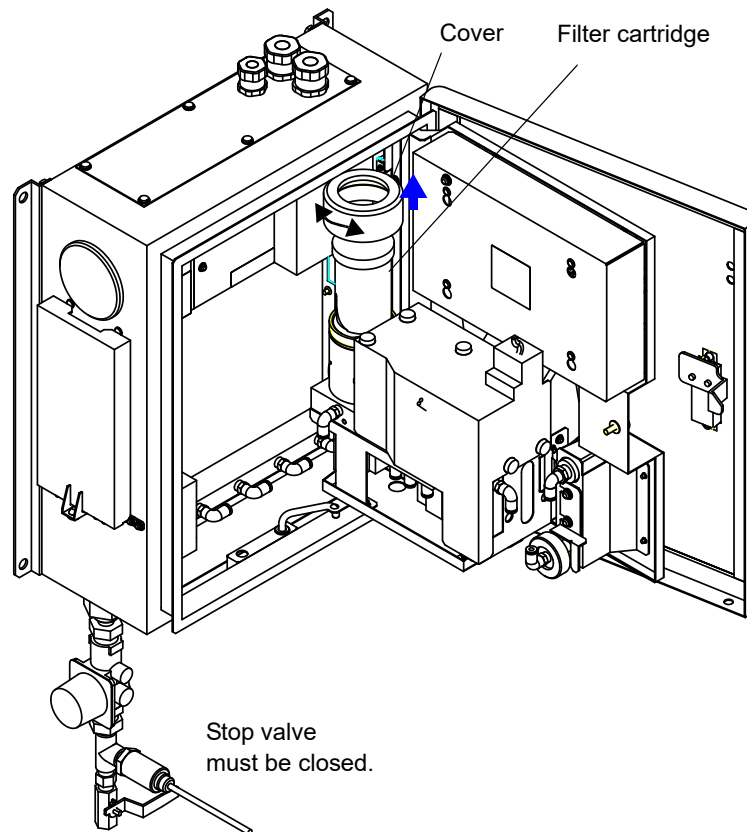

2. Insert a new filter cartridge, and screw on the cover.

Note

- Replace filter cartridge prepared only for TW-150.
 - Push the filter so that red line completely hide in the case.
-

7.4.3 Maintenance of the residual-chlorine sensor

The maintenance items and procedure are as follows.

Maintenance item	Procedure
Polish the residual-chlorine sensor	Removing the residual-chlorine sensor → Polishing the residual-chlorine sensor → Installing the residual-chlorine sensor
Replace beads	Removing the residual-chlorine sensor → Replacing beads → Installing the residual-chlorine sensor
Replace the residual-chlorine sensor	Removing the residual-chlorine sensor → New Installing the residual-chlorine sensor

● Removing the residual-chlorine sensor

1. Loosen the screws and remove the cover.

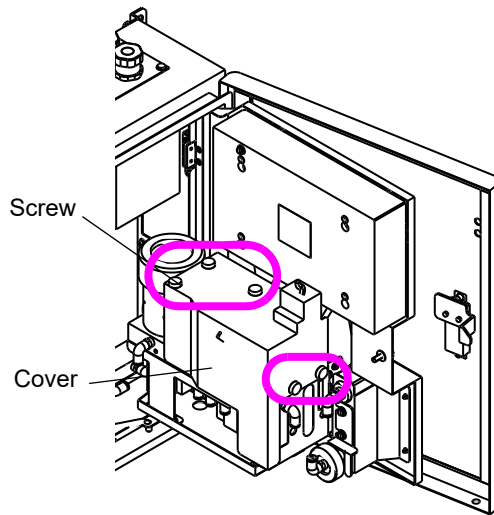

2. Remove the sensor connector.

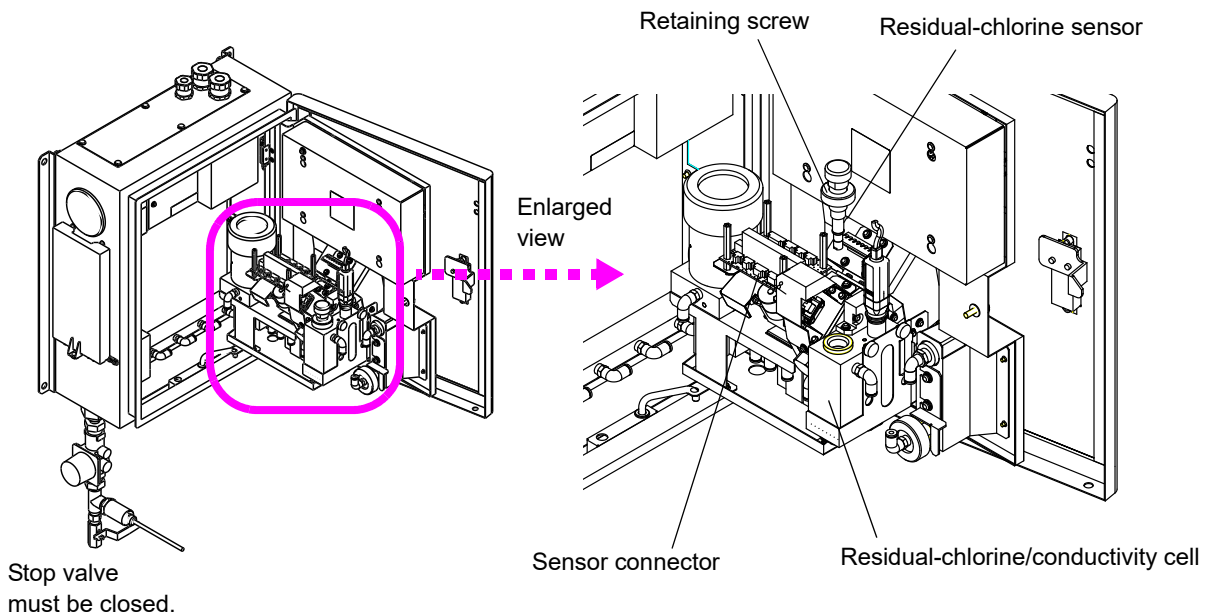

3. Loosen the sensor-retaining screw and remove the residual-chlorine sensor.

● Polishing the residual-chlorine sensor

When the sensitivity of the chlorine residual sensor declines, perform the following operation.

1. **Remove the residual-chlorine sensor from the device.**
("● Removing the residual-chlorine sensor" (page 142))
2. **Prepare the attached sandpaper.**
3. **Hold the top of residual-chlorine sensor (above reference electrode), make the tip (working electrode) of residual-chlorine sensor touched on the sand paper, and polish it about 10 times with circular orbit.**

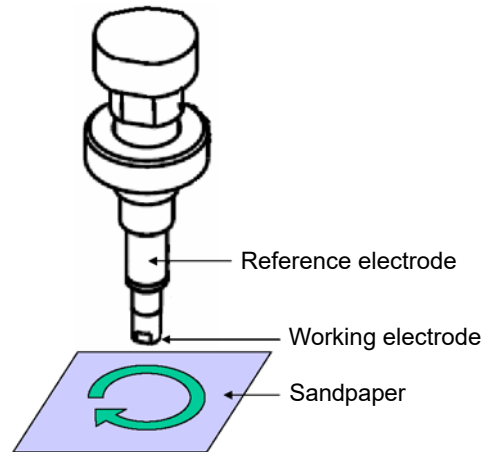

4. **After polishing, rinse the tip (working electrode) of residual-chlorine sensor using tap water, and wipe it with a lint-free cloth.**
5. **Reattach the residual-chlorine sensor.**
("● Installing the residual-chlorine sensor" (page 143))

● Replacing beads

1. **Remove the residual-chlorine sensor from the device.**
("● Removing the residual-chlorine sensor" (page 142))
2. **Replace the beads.**

Remove all beads from inside the residual-chlorine/conductivity cell using the included syringe and tube, then insert a new set of beads.

Note

Make sure to insert a full set of beads. Otherwise, the effectiveness of bead cleaning may be reduced.

3. **Reattach the residual-chlorine sensor.**
("● Installing the residual-chlorine sensor" (page 143))

● Installing the residual-chlorine sensor

1. **Fasten the residual-chlorine sensor with the retaining screw.**
2. **Connect the sensor connector.**
3. **Attach the cover and tighten the screws.**

Note

To ensure accurate measurements, after replacing the residual-chlorine sensor run sample water and operate the device for at least 2 hours before calibrating.

7.4.4 Replacing and storing the conductivity sensor (optional unit)

1. Loosen the screws and remove the cover.

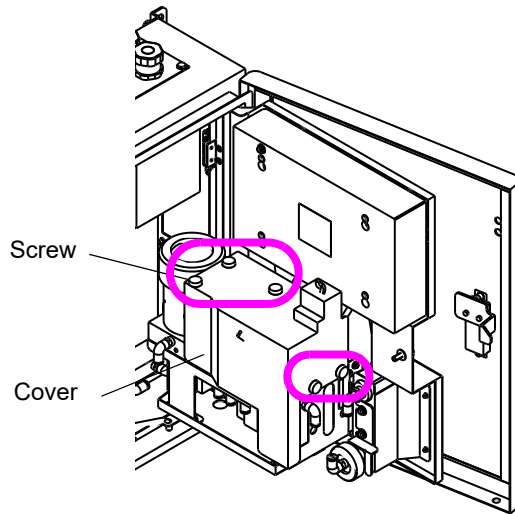

2. Remove the conductivity sensor connector.

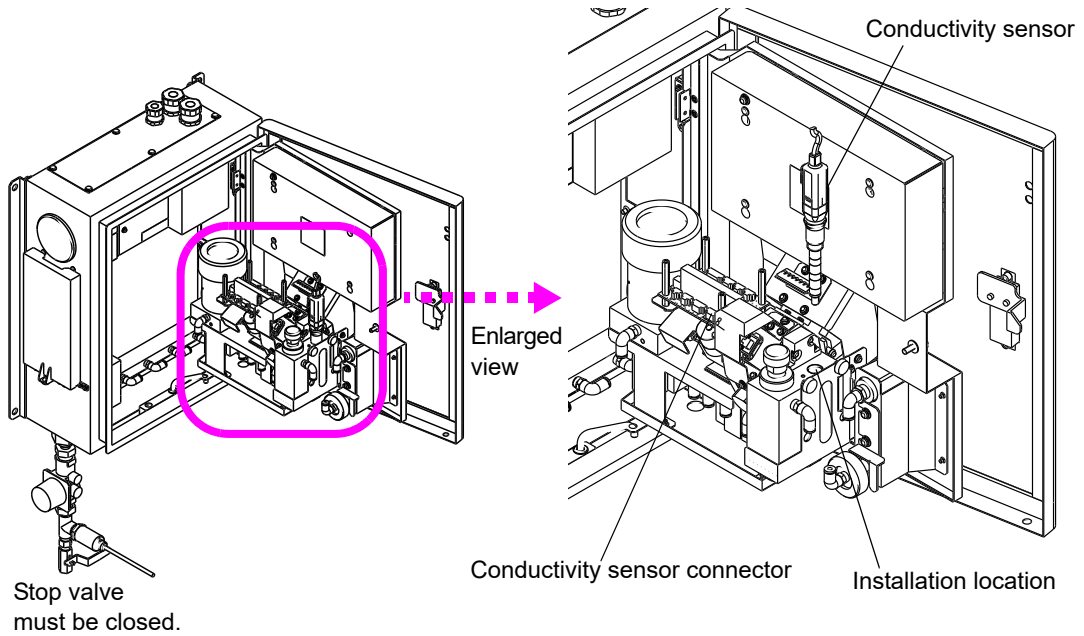

3. Rotate and remove the conductivity sensor, and insert the new one.
4. Connect the sensor connector.
5. Attach the cover and tighten the door-locking screw.

● Storing a removed conductivity sensor

Refill the attached protective cap with pure water, and attach it to the sensor.
For details, see the operating manual for the sensor.

Note

Do not dry the conductivity sensor

7.4.5 Replacing and storing the pH sensor

1. Remove the connector from the pH sensor.
2. Turn the pH sensor to the right, and pull it out.

Note

The pH sensor top is made of glass. Take care not to break it when handling.

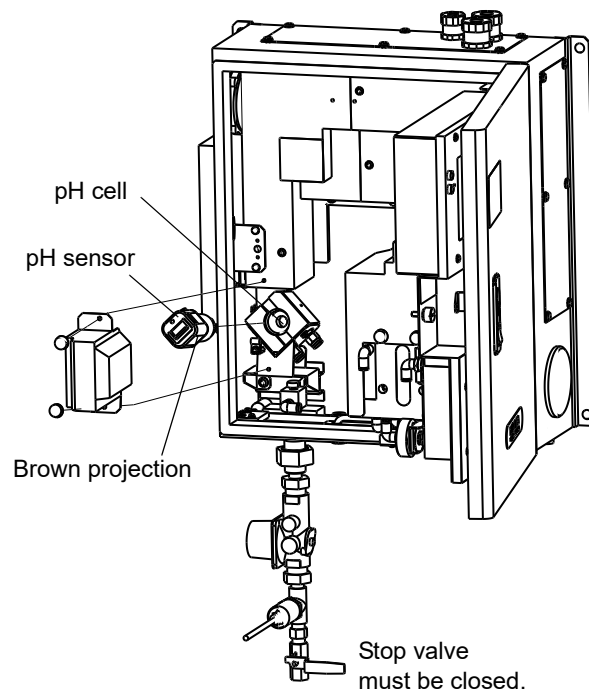

3. Remove the protective cap, liquid junction washer, rubber cap and connector cap from the new pH sensor.

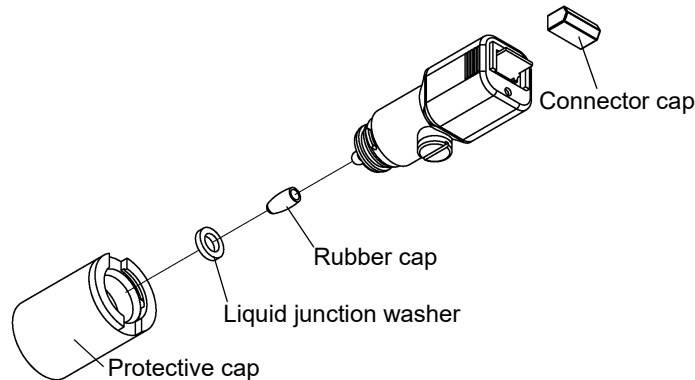

4. Push the brown protrusion on the side of the sensor into the pH cell, as shown in the following figure, and turn the sensor to the left.

Note

- The pH sensor top is made of glass. Take care not to break it when pushing the sensor in.
- Be careful not to loose the protective cap, liquid junction washer, rubber cap and connector cap as they are used to store the sensor.

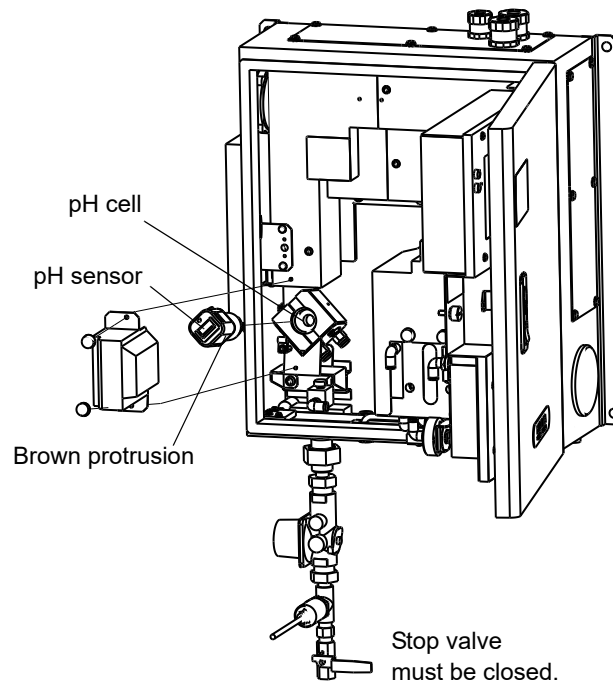

5. Connect the pH sensor to the connector.

● **Storing the removed pH sensor**

1. Soak the sponge of the protective cap in pure water.
2. Fit the cap onto the receptor glass.
3. Place the washer at the bottom of the protective cap, and attach it to the pH sensor.

For details, see the operating manual for the pH sensor.

7.5 Spare Parts

Name	Specification	Part number
Calibration solution tank	For calibration	3014039543
CF (CompactFlash) card		3014030160
Bottle for abnormal-water sampling	PP, jar, 1 L	3014039544
Residual-chlorine electrode	3440-02C	3014039554
Beads		3200063518
Conductivity sensor	9382-02C	3014039224
pH sensor	6002	3014039223
Filter cartridge	For zero water filter	3014039557
Mesh filter	For Flow Meter	3100158643
Rubber stopper	Silicon rubber stopper (#4), 2 pieces	3200091458
Syringe	Syringe 30 mL, 1 piece	3200091375
Sandpaper	1 sheet	3200091449
Dropper	Disposable, 1 piece	3200091456
Mesh filter	For Residual Chlorine	3200066663

8 TROUBLESHOOTING

8.1 Alarm List

Alarm No.	Item	Alarm Description	LED Batch alarm	Contact output Batch alarm	Analog output ALG. OUT (ALARM)	Alarm display	Alarm history
00	Common	Cell temperature adjustment abnormality	○ Lit	○	○ (All components)	○	○
01		Cell temperature adjustment warming up	● Blink	○	(WARMING UP SETTING)	○	○
02		Temperature compensation abnormality	○ Lit	○	○ (All components)	○	○
03		Cell wiper operation abnormality	○ Lit	○	○ (All components)	○	○
04		ADC communication abnormality	○ Lit *1	○	○ (All components)	○	○
05		Leak	○ Lit	○	○ (All components)	○	○
06		PIO communication abnormality	○ Lit *2	○ *2	○ (All components)*2	○	○
07		Power ON/OFF					○
08		Battery abnormality	● Blink	○		○	○
10	Turbidity	Concentration upper limit	● Blink	○		○	○
11		Concentration lower limit	● Blink	○		○	○
12		Concentration device upper limit	○ Lit	○	○ (Turbidity)	○	○
13		Concentration device lower limit	○ Lit	○	○ (Turbidity)	○	○
14		Light source abnormality	○ Lit	○	○ (Turbidity)	○	○
15		Zero calibration	● Blink	○		○	○
16		Span calibration	● Blink	○		○	○
17		Analyzer abnormality	○ Lit	○	○ (Turbidity)	○	○

Alarm No.	Item	Alarm Description	LED Batch alarm	Contact output Batch alarm	Analog output ALG. OUT (ALARM)	Alarm display	Alarm history
20	Color	Concentration upper limit	● Blink	○		○	○
21		Concentration lower limit	● Blink	○		○	○
22		Concentration device upper limit	○ Lit	○	○ (Color)	○	○
23		Concentration device lower limit	○ Lit	○	○ (Color)	○	○
24		Light source abnormality	○ Lit	○	○ (Color)	○	○
25		Zero calibration	● Blink	○		○	○
26		Span calibration	● Blink	○		○	○
27		Analyzer abnormality	○ Lit	○	○ (Color)	○	○
30		Residual chlorine	Concentration upper limit	● Blink	○		○
31	Concentration lower limit		● Blink	○		○	○
32	Concentration device upper limit		○ Lit	○	○ (Residual chlorine)	○	○
33	Concentration device lower limit		○ Lit	○	○ (Residual chlorine)	○	○
35	Zero calibration		● Blink	○		○	○
36	Span calibration		● Blink	○		○	○
37	Analyzer abnormality		○ Lit	○	○ (Residual chlorine)	○	○
40	Water pressure	Concentration upper limit	● Blink	○		○	○
41		Concentration lower limit	● Blink	○		○	○
42		Concentration device upper limit	○ Lit	○	○ (Water pressure)	○	○
43		Concentration device lower limit	○ Lit	○	○ (Water pressure)	○	○
45		Zero calibration	● Blink	○		○	○
46		Span calibration	● Blink	○		○	○
50	pH	Concentration upper limit	● Blink	○		○	○
51		Concentration lower limit	● Blink	○		○	○
52		Concentration device upper limit	○ Lit	○	○ (pH)	○	○
53		Concentration device lower limit	○ Lit	○	○ (pH)	○	○
55		Zero calibration	● Blink	○		○	○
56		Span calibration	● Blink	○		○	○

8 TROUBLESHOOTING

Alarm No.	Item	Alarm Description	LED Batch alarm	Contact output Batch alarm	Analog output ALG. OUT (ALARM)	Alarm display	Alarm history
60	Conductivity	Concentration upper limit	● Blink	○		○	○
61		Concentration lower limit	● Blink	○		○	○
62		Concentration device upper limit	○ Lit	○	○ (Conductivity)	○	○
63		Concentration device lower limit	○ Lit	○	○ (Conductivity)	○	○
65		Zero calibration	● Blink	○		○	○
66		Span calibration	● Blink	○		○	○
67		Analyzer abnormality	○ Lit	○	○ (Conductivity)	○	○
70	Water temperature	Concentration upper limit	● Blink	○		○	○
71		Concentration lower limit	● Blink	○		○	○
72		Concentration device upper limit	○ Lit	○	○ (Water temperature)	○	○
73		Concentration device lower limit	○ Lit	○	○ (Water temperature)	○	○
75		Zero calibration	● Blink	○		○	○
76		Span calibration	● Blink	○		○	○

*1 Alarm No. 04: If there is a connection failure between the ADC and internal CPU circuit boards, the LED is not lit.

*2 Alarm No. 06: If there is a connection failure between the PIO and internal CPU circuit boards, the LED is not lit.
Also the contact outputs are OFF and analog output is 0 mA.

8.2 Alarm Causes and Corrective Actions

Alarm No.	Item	Alarm description	Cause	Corrective action (*: Manufacturer service required)	Reference
00	Common	Cell temperature adjustment abnormality	Connection failure in heater temperature sensor or heater	Inspect heater temperature sensor or heater connection.*	
			Failure in temperature sensor in measurement cell	Replace heater temperature sensor.*	
			Heater disconnection	Replace heater.*	
			Internal analog circuit board failure	Replace internal analog circuit board.*	
01		Cell temperature adjustment warming up	Waiting for cell temperature adjustment to finish	This is not abnormal condition. (Cell temperature adjustment takes approximately 20 minutes to become stable.)	
02		Temperature compensation abnormality	Connection failure in residual chlorine electrode	Inspect residual chlorine electrode connection.	page 142
			Failure in residual chlorine temperature compensation sensor	Replace residual chlorine electrode.	
03		Cell wiper operation abnormality	Operation abnormality caused by foreign particles in cell	Clean turbidity/color cell, remove foreign particles.*	
	Connection failure in motor or photo sensor		Inspect motor or photo sensor connection.*		
	Cell wiper motor failure		Replace cell wiper motor*		
	Failure in detection photo sensor for cell wiper position		Replace detection photo sensor for cell wiper position.*		
04	ADC communication abnormality	Connection failure in internal analog circuit board	Inspect connection between internal analog and CPU circuit boards.*		
		Internal analog circuit board failure	Replace internal analog circuit board (TW-ADC-01).*		
05	Leak	Connection failure in inner piping	Inspect inner piping connection.*		
		Leaks in inner piping, parts	Replace inner piping or parts.*		
		Leak in wiper-axis sealing	Replace parts.*		
06	PIO communication abnormality	Connection failure in internal I/O circuit board	Inspect connection between internal I/O and CPU circuit boards.*		
		Internal I/O circuit board failure	Replace internal I/O circuit board (TW-PIO-01).*		
07	Power ON/OFF	Power disconnection caused by a blackout	This is not abnormal condition.		
08	Battery abnormality	Clock backup battery expiration	Replace clock backup battery.*		

8 TROUBLESHOOTING

Alarm No.	Item	Alarm description	Cause	Corrective action (*: Manufacturer service required)	Reference
10	Turbidity	Concentration upper limit	Air bubbles in turbidity/color cell	Perform auto cleaning.	page 105
			Sample water abnormality	Manually analyze sample water.	
			Mismatched calibration results	Perform calibration.	page 42
			Dirt in turbidity/color cell	Clean turbidity/color cell.*	
			Detector failure	Replace detector.*	
11		Concentration lower limit	Sample water abnormality	Manually analyze sample water.	
			Degradation in zero water filter	Replace filter cartridge.	page 141
			Mismatched calibration results	Perform calibration.	page 42
				Clean turbidity/color cell.*	
			Dirt in turbidity/color cell	Clean turbidity/color cell.*	
Detector failure	Replace detector.*				
12	Turbidity	Concentration device upper limit	Sample water abnormality	Manually analyze sample water.	
			Mismatched calibration results	Perform calibration.	page 42
			Dirt in turbidity/color cell	Clean turbidity/color cell.*	
			Detector failure	Replace detector.*	
			Internal analog circuit board failure	Replace internal analog circuit board (TW-ADC-01).*	
13		Concentration device lower limit	Sample water abnormality	Manually analyze sample water.	
			Degradation in zero water filter	Replace filter cartridge.	page 141
			Mismatched calibration results	Perform calibration.	page 42
				Clean turbidity/color cell.*	
			Dirt in turbidity/color cell	Clean turbidity/color cell.*	
	Detector failure		Replace detector.*		
	Internal analog circuit board failure		Replace internal analog circuit board (TW-ADC-01).*		

Alarm No.	Item	Alarm description	Cause	Corrective action (*: Manufacturer service required)	Reference
14		Light source abnormality	Degradation or failure in turbidity light source (LED)	Readjust or replace turbidity light source.*	
			Detector failure	Replace detector.*	
			Internal analog circuit board failure	Replace internal analog circuit board (TW-ADC-01).*	
			Connection failure in light source or detector	Inspect light source or detector connection.*	
15		Zero calibration	Degradation in zero water filter	Replace filter cartridge.	page 141
			Mismatching calibration solution	Replace calibration solution and reexecute calibration.	page 42
			Blockage in calibration solenoid valve	Replace calibration solenoid valve.*	
			Detector failure	Replace detector.*	
16	Turbidity	Span calibration	Mismatched calibration results	Reset calibration value and reexecute calibration.	page 42
			Mismatching calibration solution	Replace calibration solution and reexecute calibration.	
			Blockage in calibration solenoid valve	Replace calibration solenoid valve.*	
			Detector failure	Replace detector.*	
17		Analyzer abnormality	Degradation in zero water filter	Replace filter cartridge.	page 141
			Mismatched calibration results	Execute calibration.	page 42
			Dirt in turbidity/color cell	Clean turbidity/color cell.*	
			Detector failure	Replace detector.*	
			Internal analog circuit board failure	Replace internal analog circuit board (TW-ADC-01).*	
20	Color	Concentration upper limit	Air bubbles in turbidity/color cell	Perform auto cleaning.	page 105
			Sample water abnormality	Manually analyze sample water.	page 31
			Mismatched calibration results	Execute calibration.	
			Dirt in turbidity/color cell	Clean turbidity/color cell.*	
			Detector failure	Replace detector.*	

8 TROUBLESHOOTING

Alarm No.	Item	Alarm description	Cause	Corrective action (*: Manufacturer service required)	Reference
21	Color	Concentration lower limit	Sample water abnormality	Manually analyze sample water.	
			Degradation in zero water filter	Replace filter cartridge.	page 141
			Mismatched calibration results	Perform calibration.	page 31
				Clean turbidity/color cell.*	
			Dirt in turbidity/color cell	Clean turbidity/color cell.*	
Detector failure		Replace detector.*			
22		Concentration device upper limit	Sample water abnormality	Manually analyze sample water.	
			Mismatched calibration results	Perform calibration.	page 31
			Dirt in turbidity/color cell	Clean turbidity/color cell.*	
			Detector failure	Replace detector*	
			Internal analog circuit board failure	Replace internal analog circuit board (TW-ADC-01).*	
23		Concentration device lower limit	Sample water abnormality	Manually analyze sample water.	
			Degradation in zero water filter	Replace filter cartridge.	page 141
			Mismatched calibration results	Perform calibration.	page 31
				Clean turbidity/color cell.*	
			Dirt in turbidity/color cell	Clean turbidity/color cell.*	
			Detector failure	Replace detector.*	
Internal analog circuit board failure		Replace internal analog circuit board (TW-ADC-01).*			
24		Light source abnormality	Degradation or failure in turbidity light source (LED)	Readjust or replace turbidity light source.*	
			Detector failure	Replace detector.*	
	Internal analog circuit board failure		Replace internal analog circuit board (TW-ADC-01).*		
	Connection failure in light source or detector		Inspect light source or detector connection.*		

Alarm No.	Item	Alarm description	Cause	Corrective action (*: Manufacturer service required)	Reference
25	Color	Zero calibration	Degradation in zero water filter	Replace filter cartridge.	page 141
			Mismatching calibration solution	Replace calibration solution and reexecute calibration.	page 31
			Blockage in calibration solenoid valve	Replace calibration solenoid valve.*	
			Detector failure	Replace detector*	
26		Span calibration	Mismatched calibration results	Reset calibration value and reexecute calibration.	page 31
			Mismatching calibration solution	Replace calibration solution and reexecute calibration.	
			Blockage in calibration solenoid valve	Replace calibration solenoid valve.*	
			Detector failure	Replace detector*	
27	Analyzer abnormality	Degradation in zero water filter	Replace filter cartridge.	page 141	
		Mismatched calibration results	Perform calibration.	page 31	
		Dirt in turbidity/color cell	Clean turbidity/color cell.*		
		Detector failure	Replace detector.*		
		Internal analog circuit board failure	Replace internal analog circuit board (TW-ADC-01).*		
30	Residual chlorine	Concentration upper limit	Sample water abnormality	Manually analyze sample water.	
			Inappropriate flow rate	Check the flow rate.	page 11
			Mismatched calibration results	Perform calibration.	page 62
			Inappropriate applied voltage	Set appropriate applied voltage.	page 103
			Electrode failure	Polish residual-chlorine sensor or Replace residual-chlorine sensor.	page 142
			Internal analog circuit board failure	Replace internal analog circuit board (TW-ADC-01).*	
31		Concentration lower limit	Sample water abnormality	Manually analyze sample water.	
			Inappropriate flow rate	Check the flow rate.	page 11
			Mismatched calibration results	Perform calibration.	page 62
			Inappropriate applied voltage	Set appropriate applied voltage.	page 103
			Electrode failure	Polish residual chlorine sensor or Replace residual-chlorine sensor.	page 142
			Internal analog circuit board failure	Replace internal analog circuit board (TW-ADC-01).*	

8 TROUBLESHOOTING

Alarm No.	Item	Alarm description	Cause	Corrective action (*: Manufacturer service required)	Reference
32	Residual chlorine	Concentration device upper limit	Sample water abnormality	Manually analyze sample water.	
			Mismatched calibration results	Perform calibration.	page 62
			Inappropriate applied voltage	Set appropriate applied voltage.	page 103
			Electrode failure	Replace residual-chlorine sensor.	page 142
			Internal analog circuit board failure	Replace internal analog circuit board (TW-ADC-01).*	
33	Residual chlorine	Concentration device lower limit	Sample water abnormality	Manually analyze sample water	
			Mismatched calibration results	Perform calibration.	page 62
			Inappropriate applied voltage	Set appropriate applied voltage.	page 103
			Electrode failure	Replace residual-chlorine sensor.	page 142
			Internal analog circuit board failure	Replace internal analog circuit board (TW-ADC-01).*	
35	Residual chlorine	Zero calibration	Degradation in zero water filter	Replace filter cartridge.	page 141
			Mismatching calibration solution	Replace calibration solution and reexecute calibration.	page 62
			Electrode failure	Replace residual-chlorine sensor.	page 142
			Blockage in calibration solenoid valve	Replace calibration solenoid valve.*	
36	Residual chlorine	Span calibration	Mismatched calibration results	Reset calibration value and reexecute calibration.	page 62
			Mismatching calibration solution	Replace calibration solution and reexecute calibration.	
			Electrode failure	Replace residual-chlorine sensor.	page 142
			Blockage in calibration solenoid valve	Replace calibration solenoid valve.*	
37	Residual chlorine	Analyzer abnormality	Degradation in zero water filter	Replace filter cartridge.	page 141
			Mismatched calibration results	Perform calibration.	page 62
			Electrode failure	Replace residual-chlorine sensor.	page 142
			Internal analog circuit board failure	Replace internal analog circuit board (TW-ADC-01).*	

Alarm No.	Item	Alarm description	Cause	Corrective action (*: Manufacturer service required)	Reference	
40	Water pressure	Concentration upper limit	Rise in sample water pressure	Check sample water pressure.		
			Connection failure in pressure sensor connector	Inspect pressure sensor connection.*		
			Pressure sensor failure	Replace pressure sensor.*		
			Internal analog circuit board failure	Replace internal analog circuit board (TW-ADC-01).*		
41		Concentration lower limit	Drop in sample water pressure	Check sample water pressure.		
			Connection failure in pressure sensor connector	Inspect pressure sensor connection.*		
			Pressure sensor failure	Replace pressure sensor.*		
			Internal analog circuit board failure	Replace internal analog circuit board (TW-ADC-01).*		
42		Concentration device upper limit	Connection failure in pressure sensor connector	Inspect pressure sensor connection.*		
			Pressure sensor failure	Replace pressure sensor.*		
			Internal analog circuit board failure	Replace internal analog circuit board (TW-ADC-01).*		
43		Concentration device lower limit	Connection failure in pressure sensor connector	Inspect pressure sensor connection.*		
	Pressure sensor failure		Replace pressure sensor.*			
	Internal analog circuit board failure		Replace internal analog circuit board (TW-ADC-01).*			
45	Zero calibration	Mismatched calibration results	Reset calibration value and reexecute calibration.	page 71		
		Mismatching calibration pressure	Check calibration pressure and reexecute calibration.			
		Connection failure in pressure sensor connector	Inspect pressure sensor connection.*			
		Pressure sensor failure	Replace pressure sensor.*			
		Internal analog circuit board failure	Replace internal analog circuit board (TW-ADC-01).*			
46	Water pressure	Span calibration	Mismatched calibration results	Reset calibration value and reexecute calibration.	page 71	
			Mismatching calibration pressure	Check calibration pressure and reexecute calibration.		
			Connection failure in pressure sensor connector	Inspect pressure sensor connection.*		
			Pressure sensor failure	Replace pressure sensor.*		
			Internal analog circuit board failure	Replace internal analog circuit board (TW-ADC-01).*		

8 TROUBLESHOOTING

Alarm No.	Item	Alarm description	Cause	Corrective action (*: Manufacturer service required)	Reference		
50	pH	Concentration upper limit	Sample water abnormality	Manually analyze sample water.			
			Dirt in pH sensor	Clean pH sensor.			
			Connection failure in pH sensor connector	Inspect pH sensor connection.*	page 138		
			pH sensor expiration or failure	Replace pH sensor.	page 145		
			Internal analog circuit board failure	Replace internal analog circuit board (TW-ADC-01).*			
51		pH	Concentration lower limit	Sample water abnormality	Manually analyze sample water.		
				Dirt in pH sensor	Clean pH sensor.		
				Connection failure in pH sensor connector	Inspect pH sensor connection.*	page 138	
				pH sensor expiration or failure	Replace pH sensor.	page 145	
				Internal analog circuit board failure	Replace internal analog circuit board (TW-ADC-01).*		
52	pH		Concentration device upper limit	Connection failure in pH sensor connector	Inspect pH sensor connection.*	page 138	
				pH sensor expiration or failure	Replace pH sensor.	page 145	
				Internal analog circuit board failure	Replace internal analog circuit board (TW-ADC-01).*		
53			pH	Concentration device lower limit	Connection failure in pH sensor connector	Inspect pH sensor connection.*	page 138
					pH sensor expiration or failure	Replace pH sensor.	page 145
		Internal analog circuit board failure			Replace internal analog circuit board (TW-ADC-01).*		
55		pH		Zero calibration	Mismatched calibration results	Reset calibration value and reexecute calibration.	page 24
					Mismatching calibration solution	Check calibration solution and reexecute calibration.	
					Connection failure in pH sensor connector	Inspect pH sensor connection.*	page 138
					pH sensor expiration or failure	Replace pH sensor.	page 145
	Internal analog circuit board failure				Replace internal analog circuit board (TW-ADC-01).*		
56	pH			Span calibration	Mismatched calibration results	Reset calibration value and reexecute calibration.	page 24
					Mismatching calibration solution	Check calibration solution and reexecute calibration.	
			Connection failure in pH sensor connector		Inspect pH sensor connection.*	page 138	
			pH sensor expiration or failure		Replace pH sensor.	page 145	
			Internal analog circuit board failure		Replace internal analog circuit board (TW-ADC-01).*		

Alarm No.	Item	Alarm description	Cause	Corrective action (*: Manufacturer service required)	Reference		
60	Conductivity	Concentration upper limit	Sample water abnormality	Manually analyze sample water.			
			Dirt in conductivity sensor	Clean conductivity sensor.			
			Connection failure in conductivity sensor connector	Inspect conductivity sensor connection.*	page 138		
			Conductivity sensor expiration or failure	Replace conductivity sensor.	page 144		
			Internal analog circuit board failure	Replace internal analog circuit board (TW-ADC-01).*			
61		Conductivity	Concentration lower limit	Sample water abnormality	Manually analyze sample water.		
				Dirt in conductivity sensor	Clean conductivity sensor.		
				Connection failure in conductivity sensor connector	Inspect conductivity sensor connection.*	page 138	
				Conductivity sensor expiration or failure	Replace electric-conductivity sensor.	page 144	
				Internal analog circuit board failure	Replace internal analog circuit board (TW-ADC-01).*		
62	Conductivity		Concentration device upper limit	Connection failure in conductivity sensor connector	Inspect conductivity sensor connection.*	page 138	
				Conductivity sensor expiration or failure	Replace electric conductivity sensor.	page 144	
				Internal analog circuit board failure	Replace internal analog circuit board (TW-ADC-01).*		
63			Conductivity	Concentration device lower limit	Connection failure in conductivity sensor connector	Inspect conductivity sensor connection.*	page 138
					Conductivity sensor expiration or failure	Replace electric-conductivity sensor.	page 144
		Internal analog circuit board failure			Replace internal analog circuit board (TW-ADC-01).*		
65		Conductivity		Zero calibration	Mismatched calibration results	Reset calibration value and reexecute calibration.	page 53
					Mismatching calibration solution	Check calibration solution and reexecute calibration.	
					Connection failure in conductivity sensor connector	Inspect conductivity sensor connection.*	page 138
					Conductivity sensor expiration or failure	Replace electric-conductivity sensor.	page 144
	Internal analog circuit board failure				Replace internal analog circuit board (TW-ADC-01).*		

8 TROUBLESHOOTING

Alarm No.	Item	Alarm description	Cause	Corrective action (*: Manufacturer service required)	Reference
66	Conductivity	Span calibration	Mismatched calibration results	Reset calibration value and reexecute calibration.	page 53
			Mismatching calibration solution	Check calibration solution and reexecute calibration.	
			Connection failure in conductivity sensor connector	Inspect conductivity sensor connection.*	page 138
			Conductivity sensor expiration or failure	Replace electric-conductivity sensor.	page 144
			Internal analog circuit board failure	Replace internal analog circuit board (TW-ADC-01).*	
67		Analyzer abnormality	Mismatched calibration results	Perform calibration.	page 53
			Dirt in conductivity sensor	Clean conductivity sensor.	
			Conductivity sensor expiration or failure	Replace electric-conductivity sensor.	page 144
			Internal analog circuit board failure	Replace internal analog circuit board (TW-ADC-01).*	
70	Water temperature	Concentration upper limit	Sample water temperature abnormality	Check sample water temperature.	
			Connection failure in water temperature sensor connector	Inspect water temperature sensor connection.*	
			Water temperature sensor failure	Replace water temperature sensor.*	
			Internal analog circuit board failure	Replace internal analog circuit board (TW-ADC-01).*	

Alarm No.	Item	Alarm description	Cause	Corrective action (*: Manufacturer service required)	Reference
71	Water temperature	Concentration lower limit	Sample water abnormality	Check sample water temperature.	
			Connection failure in water temperature sensor connector	Inspect water temperature sensor connection.*	
			Water temperature sensor failure	Replace water temperature sensor.*	
			Internal analog circuit board failure	Replace internal analog circuit board (TW-ADC-01).*	
72		Concentration device upper limit	Connection failure in water temperature sensor connector	Inspect water temperature sensor connection.*	
			Water temperature sensor failure	Replace water temperature sensor.*	
			Internal analog circuit board failure	Replace internal analog circuit board (TW-ADC-01).*	
73		Concentration device lower limit	Connection failure in water temperature sensor connector	Inspect water temperature sensor connection.*	
			Water temperature sensor failure	Replace water temperature sensor.*	
			Internal analog circuit board failure	Replace internal analog circuit board (TW-ADC-01).*	
75		Zero calibration	Mismatched calibration results	Reset calibration value and reexecute calibration.	page 73
			Mismatching calibration temperature	Check calibration temperature and reexecute calibration.	
	Connection failure in water temperature sensor connector		Inspect water temperature sensor connection.*		
	Water temperature sensor failure		Replace water temperature sensor.*		
	Internal analog circuit board failure		Replace internal analog circuit board (TW-ADC-01).*		
76	Span calibration	Mismatched calibration results	Reset calibration value and reexecute calibration.	page 73	
		Mismatching calibration temperature	Check calibration temperature and reexecute calibration.		
		Connection failure in water temperature sensor connector	Inspect water temperature sensor connection.*		
		Water temperature sensor failure	Replace water temperature sensor.*		
		Internal analog circuit board failure	Replace internal analog circuit board (TW-ADC-01).*		

9 REFERENCE

9.1 Specifications

Product name	Water Distribution Monitor
Type	TW-150
Measurement items	(Standard configuration) turbidity, color, free residual chlorine, water pressure, pH (Optional items) conductivity, water temperature *Measurements apply to tap water described in "Table 1 (page 164)".
Measurement Method	See "Table 2 (page 164)".
Measurement range	See "Table 2 (page 164)".
Repeatability	See "Table 2 (page 164)".
Display system	LCD display 320 × 240 dot backlit change to five graphic liquid-crystal display (touch panel type) Up to seven items including five items from standard configuration (turbidity, color, free residual chlorine, water pressure, pH) and optional items (conductivity, water temperature) can be displayed at the same time.
Calibration method	See "Table 2 (page 164)".
Automatic zero calibration	(Turbidity, color, free residual chlorine) Calibration method: Filtrate sample water Calibration start: Interior...started by internal timer Exterior...started by external contact input Calibration cycle: 5 hours to 9999 hours (user setting) Calibration time: Approx. 15 minutes
Automatic cleaning	(Turbidity, color) Cleaning method: Cell window cleaning using wiper Cleaning start: Interior...started by internal timer Exterior...started by external contact input Cleaning interval: 5 to 9999 minutes (user setting) (Free residual chlorine) Continuous cleaning using beads
Automatic draining	Draining start: Interior...started by internal timer Draining interval: 5 to 9999 minutes (user setting)
Sample water condition	Temperature: 0°C to 40°C (do not freeze) Pressure: 0.1 MPa to 0.75 MPa Conductivity: 10 mS/m or higher Analyzing unit input rate (flow rate): 50 mL/min to 100 mL/min <ul style="list-style-type: none"> ● In test operation, flush the meter thoroughly before running water. ● Make sure to set up a bypass for piping to the meter. ● If sample water may freeze, take measures to insulate the unit from cold and to retain heat. ● Sample Water measured with this device cannot be distributed.
Ambient temperature, humidity	Ambient temperature: 0°C to 40°C Ambient humidity: 85% or lower
Analog output	Type: Measurement values: Number of outputs corresponds to number of measurement values (up to seven values including five values of the standard configuration) Specifications: 4 mA to 20 mA DC, insulated output (non-insulated between items) Maximum load resistance: 600 Ω

Contact output	<p>Types: Power failure, batch alarm, maintenance</p> <p>Contents: Power failure...occurs when the power is turned off Batch alarm...cell temperature adjustment abnormality, temperature compensation abnormality, cell wiper abnormality, internal communication abnormality, leak, battery abnormality, concentration upper limit concentration lower limit, concentration device upper limit, concentration device lower limit, light source abnormality zero calibration, span calibration, analyzer abnormality</p> <p>Maintenance...when the system enters maintenance or calibration mode</p> <p>Specifications: No-voltage contact output, a contact interface Contact rating: 125 V AC 0.3 A, 30 V DC 1 A (at resistance load) Each output is an independent COM interface.</p>
Contact input	<p>Type: Cleaning start, zero calibration start, alarm check setting, abnormal water sampling</p> <p>Contents: Cleaning start...started by closed contact input Zero calibration start...started by closed contact input Alarm check setting...started by closed contact input Abnormal water sampling... started by closed contact input</p> <p>Specifications: No-voltage contact input (open collector connection is possible), insulated input ON resistance: maximum 100 Ω Open voltage: 24 V DC Short-circuit current: maximum 13 mA</p>
Communication	<p>Interface: RS-232C compatible</p> <p>Communication speed: 19200 bps</p>
Function	<p>Integrating function for flow rate used in the system (counting type)</p> <p>Internal leak detecting function</p>
Data memory	<p>Measurement data is stored on system, and can be transferred to a Compact Flash card (CF Card).</p> <p>Data saving interval: 1 minute or 1 hour</p> <p>Data Saving Frequency: 1 minute: Saves at every 0 second of the minute 1 hour: Saves at every 0 second of the hour</p> <p>Data memory time: 1 minute interval...for approx. 10 days 1 hour interval...for approx. 1 year</p> <p>The latest data will be stored.</p>
Wiring connector	<p>Wiring inlet</p> <p>Compliant cable: 12.5 mm dia. to 14.5 mm dia.</p> <p>Power source: 4.5 mm dia. to 6 mm dia.</p>
Pipe connector	<p>Sample inlet: Rc1/4</p> <p>Condensate outlet: Rc1/8</p> <p>Drain: Rc1/4</p> <p>Condensate outlet (internal): 6 mm dia. hose nipple</p> <p>Air opening: Rc1/8</p> <p>Condensate outlet (for detection): 6 mm dia. hose nipple (Rc1/8)</p> <p>Calibration inlet: Rc1/8</p>
Installation	<p>Designed for indoor installation.</p> <p>* For outdoor installation, a case is required (option).</p>
Main wetted material	C3604, SUS304, SUS316L, PP, acrylic, FKM, PEEK, PPO, PTFE, PVC, PFA, POM, EPDM, BK7, Pyrex, PET, PBT, NBR
Power supply	90 V to 264 V AC: 50/60 Hz
Power consumption	100 V to 240 V AC: Maximum 120 VA
Weight	Approx. 18 kg
Dimensions	350 (W) \times 160 (D) \times 420 (H) (unit: mm)
Paint color	Munsell 5PB 8/1

Installation environment	<ul style="list-style-type: none"> ● Flat and stable location with minimum vibrations or shocks ● No dust, mist or corrosive gas in the air ● Under atmospheric pressure ● No direct sunlight ● Good ventilation ● Altitude 2000 m or lower
--------------------------	---------------------------------------------------------------------------------------------------------------------------------------------------------------------------------------------------------------------------------------------------------------------------------------------------------

Table 1 Water quality standard

No.	Measurement item	Acceptable range
1	Turbidity	2 degree or less
2	Color	5 degree or less
3	pH	pH 5.8 to pH 8.6

This standard is defined in Japanese drinking water test method as of 2017.

Table 2 Measurement item specifications

No.	Measurement item	Measurement system	Measurement range	Repeatability	Calibration method
1	Turbidity	90 degree light scattering method	0 to 2 NTU 0 to 5 NTU 0 to 10 NTU	±2.5% of full scale	Formazine standard solution*1
2	Color	Transmitted light absorbance method	0 to 10 TCU 0 to 20 TCU	±5.0% of full scale	Standard color solution*2
3	Free residual chlorine (FRC)	Polarographic method	0 to 5 mg/L	±2.5% of full scale	DPD colorimetric method
4	Water pressure	Semiconductor detection method	0 to 1 MPa 0 to 10 Bar	±1.0% of full scale	Standard pressure gauge
5	pH	Glass electrode method	pH 2 to pH 12	±0.1 pH	pH standard solution
6	Conductivity (optional)	AC 2-Electrode	0 to 500 µS/cm 0 to 1000 µS/cm	±2.0% of full scale	KCl standard solution
7	Water temperature (optional)	Thermistor method	0 to 50°C	±0.5°C	Standard thermometer

*1,*2: Refer to page 162 for correct measurement.

9.2 Piping Flow

● Standard

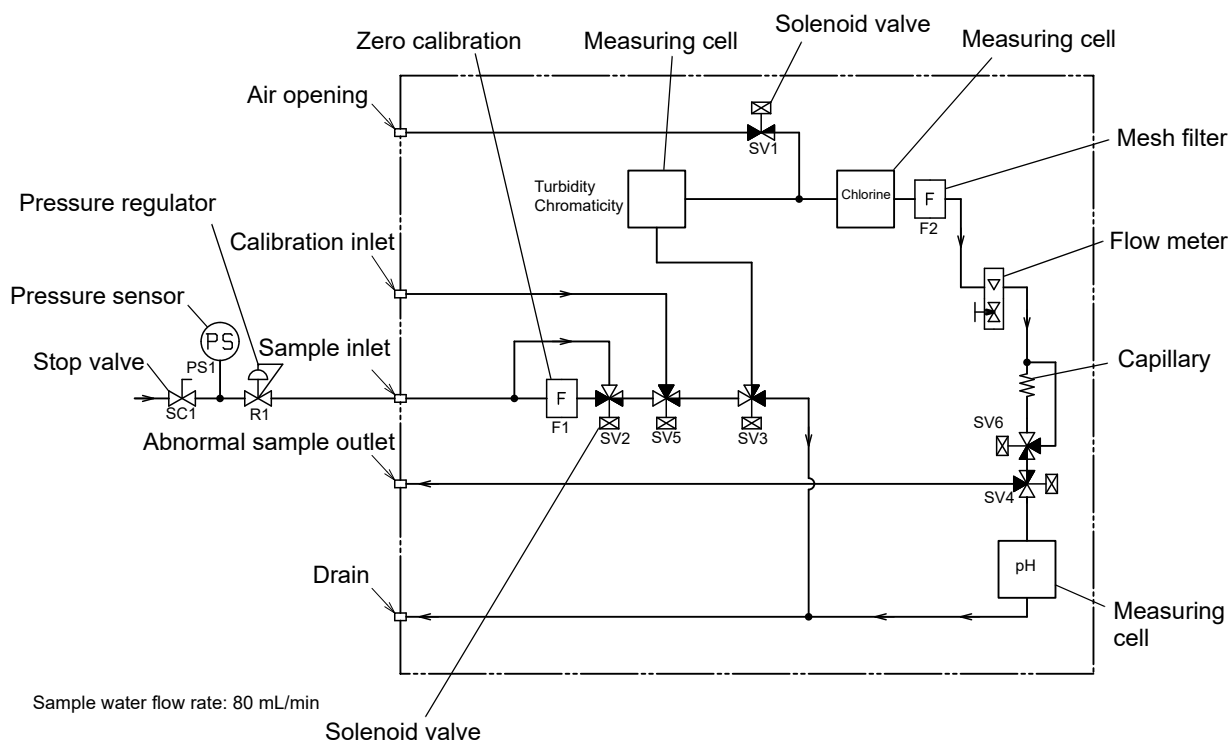

● Including optional items

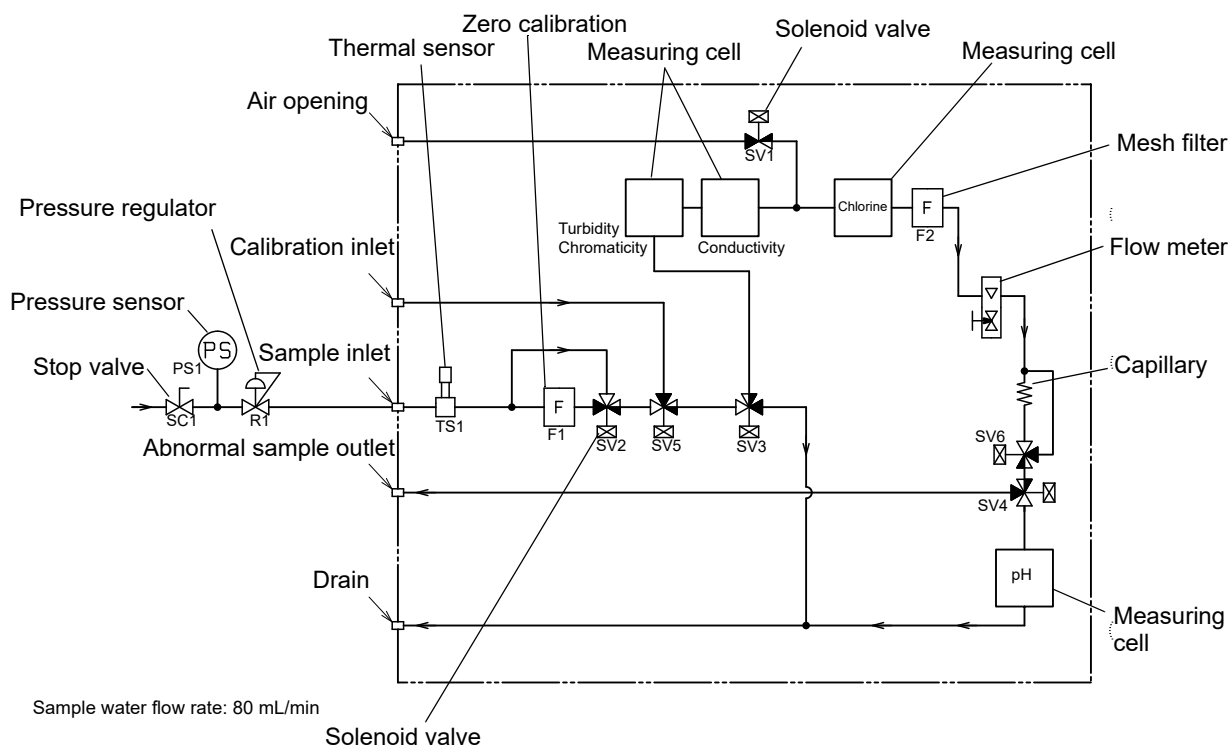

9.3 Turbidity Measurement

TW-150 operates using 90-degree light scattering method. Turbidity is calculated by measuring the scattered light caused by the particles present in the water.

When light of constant intensity is passed through the turbid water layer, turbid particles in the water will cause the light to scatter, which further increases the concentration of scattered light.

The thickness of the water layer is proportional to the density (concentration) of the turbid particles present in the water.

The light used in TW-150 has a wavelength of 870 nm, and is compliant to ISO 7027-1:2016.

9.4 Color Measurement

The transmitted light measurement method is used in TW-150. This method measures the level of brownish-yellow in yellow-like colors shown in dissolution and colloidal materials contained in water at a wavelength of 375 nm using absorptiometry.

● Evaluating the color turbidity coefficient

In sample water measurement, read measured color value X_0 when the turbidity coefficient is set to 0.000, and read measured color value X_1 when the turbidity coefficient is set to 1.000.

Then, measure the sample water using a color meter other than that in this device and evaluate X' .

$$\text{Turbidity coefficient} = \frac{X' - X_0}{X_1 - X_0}$$

Reference

See "5.10.3 Correcting color using turbidity (page 102)".

This instrument is calibrated with the span calibration standard solution described above in page 31 before sending for shipping inspection. Depending on the turbidity of the sample, measurement result may deviate from the TCU*1 manually analyzed value if default factory setting is used*2. In order to adjust the measured value of this device to the TCU measured value obtained through manual analysis, substitute the manually analyzed value as X' . In addition, since this instrument doesn't measure after filtration, deviations in measurement value obtained by manual analysis may occur if there is a change in sample properties. Perform readjustment according to the above procedure if deviations are present.

*1: TCU (True Color Unit): "True chromaticity" which is obtained by measuring the chromaticity after filtration.

*2: For manual analysis, turbidity components are removed before measuring. However, TW-150 is not equipped with a filtration feature. Instead it is equipped with turbidity compensation feature. Turbidity compensation feature is disabled for default factory setting.

9.5 Residual Chlorine Measurement

● Residual chlorine

Residual chlorine is active chlorine remaining in water from the result of tap and pool water disinfection or chlorine treatment for sterilization and deodorization in the food industry. Active chlorine is used for industrial and household disinfectant or bleach.

In water, chlorine (Cl_2), hypochlorous acid (HClO) and hypochlorite (ClO^-) are balanced according to a pH value and the compound formed from these three is called residual chlorine. In Japan, the Waterworks Law requires it to disinfect tap water and maintain residual chlorine in tap water.

● Measurement principle

As shown in Fig. 1, when gold or platinum is a cathode (working electrode) and silver/silver chloride is an anode (reference electrode) and voltage is applied between these electrodes, in the cathode, the following reduction reaction occurs in an electrode soaked in residual chlorine solution and a current flows in the external circuit.

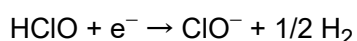

In the anode, the following oxidation reaction occurs.



This current is proportional to the amount of residual chlorine in solution, so you can measure the concentration of residual chlorine in sample water by measuring this current. This measurement method is called the polarographic method and allows simple measurement of residual chlorine differing from residual chlorine measurement methods using reagents which require complicated preparation.

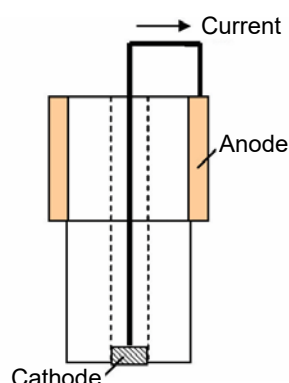

Fig. 1 Residual chlorine electrode

● Temperature compensation

The current generated in the residual chlorine electrode varies depending on the residual chlorine solution temperature. Compound movement is activated as the residual chlorine solution temperature gets higher. The reaction in the cathode is also activated and the current value is estimated high as a result. Temperature compensation means to compensate the current change in this temperature.

● pH influence

Residual chlorine is a compound that the abundance ratio of HClO and ClO^- changes depending on pH in the solution. There is almost only HClO around pH 5 and ClO^- around pH 9. The amount of HClO , the reactive factor on the cathode side changes depending on pH in the measuring solution, and the measuring current also changes in response. Therefore in residual chlorine electrode calibration, making calibration solution close to the pH in the measuring sample water is necessary.

- **Electrode cleaning**

This system adopts bead cleaning to maintain the electrode surface and measurement stable.

9.6 pH Measurement

- **pH measurement and temperature**

The temperature of the solution being inspected is an important parameter in the accurate measurement of pH. There are many possible sources of errors during measurement, such as the state of the solution junction potential, asymmetric potential, and standard solution pH concentration, but all of these items contain factors that change with the temperature. The best way to minimize these potential causes of errors is to keep the temperature of the pH standard solution uniform at the time of calibration.

- **Liquid junction potential**

“Liquid junction potential” is the electric potential that occurs to a greater or lesser degree at the liquid junction. The size of the electric potential differs depending on the type of solution, temperature of the solution, and the structure of the liquid junction.

When solutions of different compositions come in contact, ion diffusion occurs on the contact surface between the two solutions. The ions are of various sizes, so a difference occurs in the diffusion transfer speed.

As diffusion proceeds, a difference in charges occurs on the contact surface of the two solutions, giving rise to a difference in potential. This potential works to reduce the transfer speed of fast ions and increase the speed of slow ions, ultimately achieving a state of equilibrium when the transfer speed of the positive and negative ions on the contact surface of the two solutions is equal. In this state of equilibrium, the potential at the contact surface between the two solutions is called the “liquid junction potential.” A large liquid junction potential means very inaccurate measurement.

- **Asymmetric potential**

The glass electrode is immersed in a pH 7 standard solution. When the electrode is immersed in the pH 7 solution, both the internal and external sides of the electrode membrane are supposed to take on a pH of 7, making the potential 0. In actuality, however, a potential does occur. This potential is called an “asymmetric potential.” The size of an asymmetric potential differs depending on any stress that may have occurred during the processing of the glass and the shape and compositions of the glass. Asymmetric potential also changes depending on the degree of contamination of the standard solution and the state of the glass membrane. Also, if the electrode membrane dries out, a large asymmetric potential will occur, giving rise to measurement errors.

- **Temperature compensation**

The electromotive force generated by the glass electrode changes depending on the temperature of the solution. “Temperature compensation” is what is used to compensate for the change in electromotive forces caused by temperature. There is absolutely no relation between the change in pH caused by the temperature of the solution and temperature compensation. This is often misunderstood. When pH is to be measured, the temperature of the solution when the pH is measured must be recorded along with that pH value, even if a meter that has automatic temperature compensation is used. If the solution temperature is not recorded, the results of the pH measurement are relatively meaningless.

● Types of pH standard solutions

When measuring pH, the meter must be calibrated using a standard solution. There are several kinds of standard solutions. For normal measurement, two standard solutions (with a pH of 7 and 9) are sufficient to accurately calibrate the meter.

pH 1.68 standard solution: Oxalate	0.05 mol/L tetra-potassium oxalate aqueous solution
pH 4.00 standard solution: Phthalate	0.05 mol/L potassium hydrogen phthalate aqueous solution
pH 6.86 standard solution: Neutral phosphate	0.025 mol/L potassium dihydrogen phosphate, 0.025 mol/L sodium dihydrogen phosphate aqueous solution
pH 9.18 standard solution: Borate	0.01 mol/L tetra-sodium boric acid (boric sand) aqueous solution
pH 12.45 standard solution: Saturated calcium hydroxide solution	Saturated hydrogenated calcium solution

9.7 Conductivity Measurement (Optional)

“Conductivity” is an index that expresses the ease with which electric current flows through a material. Conductors are categorized either as “electron conductors,” such as metals and other substances which use free electrons to conduct electricity, or “ion conductors,” such as electrolytic solution or fused salt, which use ions to conduct electricity. This section deals with the kind of conductivity that pertains to ions, especially the conductivity of electrolytic solution that uses water as the solvent. As shown in Fig. 2, two pole plates with an area A (expressed in m^2) are positioned parallel to each other, separated by distance l (expressed in m), then solution is poured into the cell until full and alternating current is run between the plates.

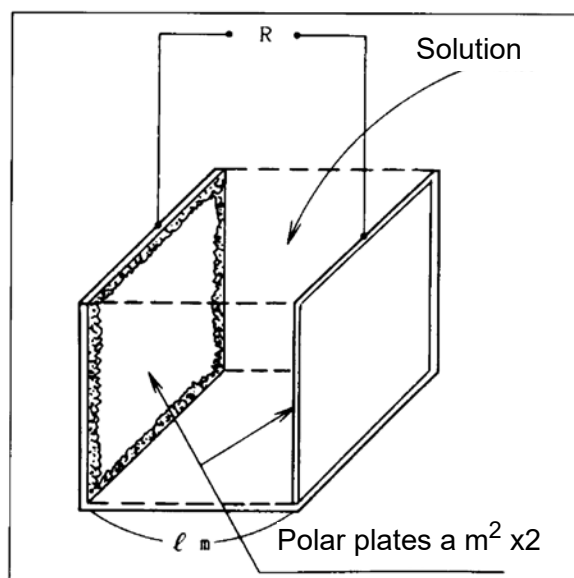

Fig. 2 Conductivity cell imitative

Each positive and negative ion in the solution will migrate toward the oppositely charged pole. The result is that current flows through the solution by means of ion conductivity. When this occurs, resistance R (expressed in Ω), is in inverse proportion to the area A (expressed in m^2) of the pole plates, as is the case with metal and other conductors, and is proportional to the distance l (expressed in m) between the two pole plates. These relationships are expressed by equation 1, below.

$$R = r \times l / a = rJ \quad (\text{Equation 1})$$

R : Resistance(Ω)

r : Specific resistance($\Omega \cdot m$)

a : Pole plate area(m^2)

l : distance between pole plates(m)

J : Cell constant(m^{-1})

Specific resistance (expressed in $\Omega \cdot m$) is an index that indicates the difficulty with which current flows and is a constant determined according to the solution. The inverse of r (expressed in $\Omega \cdot m$), which is L (and is equal to $1/r$), is called the "specific conductivity" and is widely used as an index to express the ease with which current flows. Specific conductivity L is generally referred to as simply "conductivity" and is expressed in units of S/m .

Inserting conductivity L (expressed in S/m) into equation 1 results in equation 2, below.

$$R = J/L \quad (\text{Equation 2})$$

As is clear from equation 2, when a conductivity cell having a cell constant J of $1 m^{-1}$ is used l in other words, when a conductivity cell having two pole plates that each have an area A of $1 m^2$ and are positioned parallel to each other such that the distance l between the two plates is $1 m$ is used l the inverse of the resistance R of the solution (expressed in Ω) between both pole plates is the conductivity. Conductivity is defined in this way, but it changes according to the temperature of the solution. The conductivity of a solution is generally expressed as the value when the solution is $25^\circ C$.

9.8 Evaluating Coefficients

When it is decided that there is an obvious existence of the linear function relationship between the measured concentration $X_{i,j} (i=1, 2, cn)$ and the corresponding manually-analyzed value $Y_{i,j} (i=1, 2, cn)$, the calibration curve (regression expression) is expressed by

$$Y = a + bX$$

Gradient b and Y-intercept a to the X-axis of this regression line are expressed by the least-square method using the measurement value as follows:

$$a = \bar{Y} - b\bar{X}$$

$$b = \frac{\sum(X_i - \bar{X})(Y_i - \bar{Y})}{\sum(X_i - \bar{X})^2} = \frac{n\sum X_i Y_i - (\sum X_i)(\sum Y_i)}{n\sum X_i^2 - (\sum X_i)^2}$$

a and b are rounded to one digit larger than the effective digits of the measurement value.

HORIBA Advanced Techno
<http://www.horiba-adt.jp>

Headquarters
31, Miyanonishi-cho, Kisshoin Minami-ku, Kyoto, 601-8306
TEL:+81-75-321-7184 FAX:+81-75-321-7291
