

Feature Article

In-situ Monitoring of Hazardous Ammonia in Ambient Air: Optimizing HORIBA's APNA-370 with a New NH₃ Converter

Wilma TRAVNICEK, Stefan KARWISCH,
Grischa P. FEUERSÄNGER

The following article contains the modification of a NO_x-analyzer (APNA-370) for monitoring of hazardous ammonia in ambient air at agricultural sites. HORIBA's APNA-370 was originally designed to determine NO_x/NO/NO₂ in ambient air, using the reduced pressure Chemiluminescence (CLD) method with a cross flow modulation (according to EN 14211). With the implementation of an additional converter, ammonia is transformed into nitrogen monoxide at an efficiency rate of 95 %. Therefore the modified NO_x-analyzer is suitable for quantitative determination of ambient ammonia. The Hessen Agency for Environment and Geology (HLUG) used the method of ammonia permeation, which has been proven to produce a reliable span gas. The evaluation of the permeation method has revealed an error range of approximately 1 %. Currently a type approval for a NH₃-analyzer does not exist in Europe. Therefore we related to the next relevant criteria. The instrument was validated according to the conforming standards of the German (VDI 4202-1/4203-3) and European (EN 14211) type approval test.

Introduction

Legal Requirements in Germany

The World Health Organisation (WHO) defined an orientation value of 10 µg NH₃/m³ for the assessment of sensitive ecosystems.^[1] In Germany during licensing processes of agrarian facilities the authorities check if the total NH₃ exposure of sensitive ecosystems lies below this value. The total exposure is the sum of the initial pollution level and the additional load caused by the intended facility. The initial pollution level can be determined by a standard value of 7 µg/m³ that is the maximum ambient air level in the neighboring states (Netherlands, Denmark, Great Britain). Although this approach allows an additional load of 3 µg/m³^[2] more precise is the use of NH₃ data of ambient air monitoring stations. Unfortunately the number of NH₃ datasets is small due to a missing monitoring obligation in Germany.

Another reason for monitoring of ammonia in ambient air is the implementation of the Goteborg protocol that

entered into force in 2005.^[3] This protocol sets limits on emissions of sulfur dioxide (SO₂), Non-Methane Volatile Organic Compounds (NMVOC), Ammonia (NH₃) and Nitrogen Oxides (NO_x) in 2010. In the EU directive 2001/81/EF (NEC) the countries are committed to the same obligations. Aim is the control of the acidification, eutrophication, and ground-level ozone which are still problematic in spite of the emission reduction success.^[4] The Goteborg Protocol and the NEC-directive are in an amendment process in which the regulations will be tightened.

Source and Sinks for ammonia

Main source for NH₃ in the atmosphere is agriculture especially the intensive animal husbandry and fertilization. A substantial amount is emitted by the traffic sector. The NH₃ main sink is the wet and dry deposition. Anthropogenic nitrogen contamination disturbs the nutrient balance of the ecosystem and results in an acidification of soil. Ammonia and other gaseous

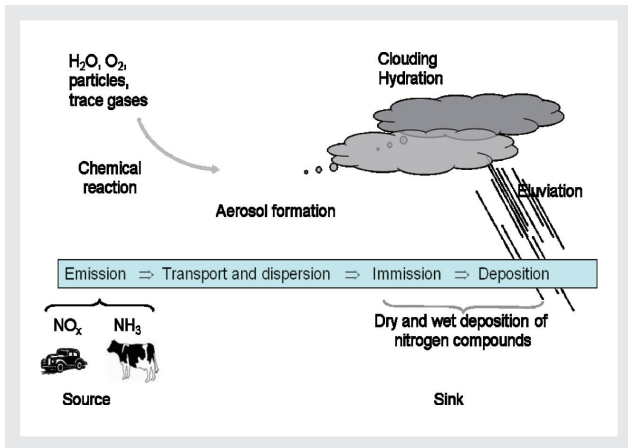

Figure 1 Atmospheric ammonia cycle.^[5]

compounds such as SO_2 or NO_x compose to secondary aerosols that contribute significant to the background level of particles (PM_{10}^{*1} , $\text{PM}_{2.5}^{*2}$). Indirectly NH_3 acts as a greenhouse gas. It is converted partly to nitrous oxide that is a greenhouse gas. Figure 1 displays schematically the ammonia cycle in the atmosphere.^[5]

*1: PM_{10} : Particulate matter with a aerodynamic diameter equal or less $10 \mu\text{m}$

*2: $\text{PM}_{2.5}$: Particulate matter with a aerodynamic diameter equal or less $2.5 \mu\text{m}$

Annual Ammonia Emissions in Germany

In Germany the ammonia emissions amount to 597 kt

(2009) and stagnated during the last decade (Figure 2).^[6] Due to the reduction of other acid pollutants such as SO_2 the NH_3 -emissions become more important. Figure 3 shows the annual agrarian ammonia emissions of dairy cows taken from the ammonia cadastre of the Umweltbundesamt (UBA) in Germany. Hot spots are the regions Vechta and Cloppenburg in Lower Saxony and Münsterland in North Rhine-Westphalia. In the neighboring Netherlands a lot of stables for factory farming are installed, too. Their emissions are transported through the atmosphere and contribute to the NH_3 -pollution in Germany.

The data sets of the emission inventories are based on estimations. At present only few ambient air measurements exist in Germany due to the fact that no legal obligation for measuring ammonia exists. Most of them are done with discontinuously methods such as passive samplers or denuders. The NH_3 data base could be improved with ambient air measurements with a high time resolution.

Materials and Methods

Measurement Principle

The molecules of a gas sample containing Nitrogen Monoxide (NO) and Nitrogen Dioxide (NO_2) react with supplied Ozone (O_3). Part of the NO is oxidized to NO_2 . The newly generated NO_2 is partly in an activated or excited state (NO_2^*). It emits light, when it returns to its

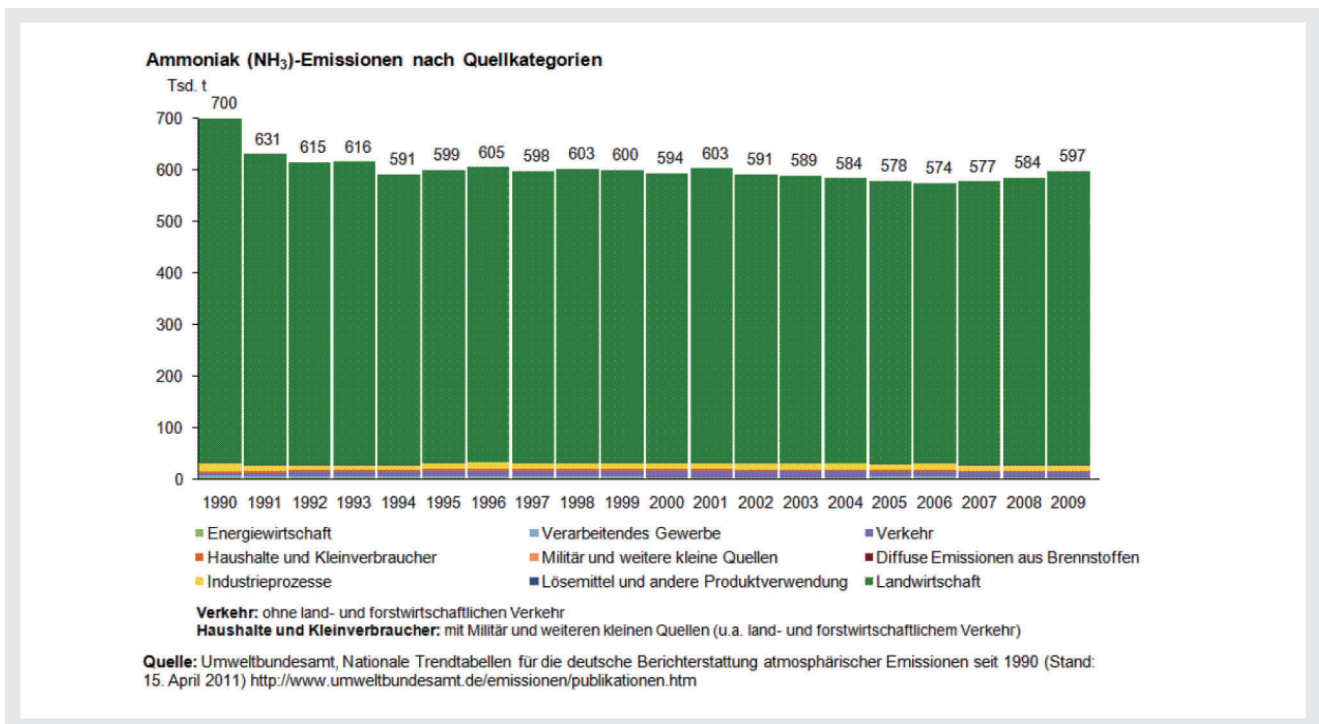

Figure 2 Ammonia emissions in Germany divided by sources.^[6]

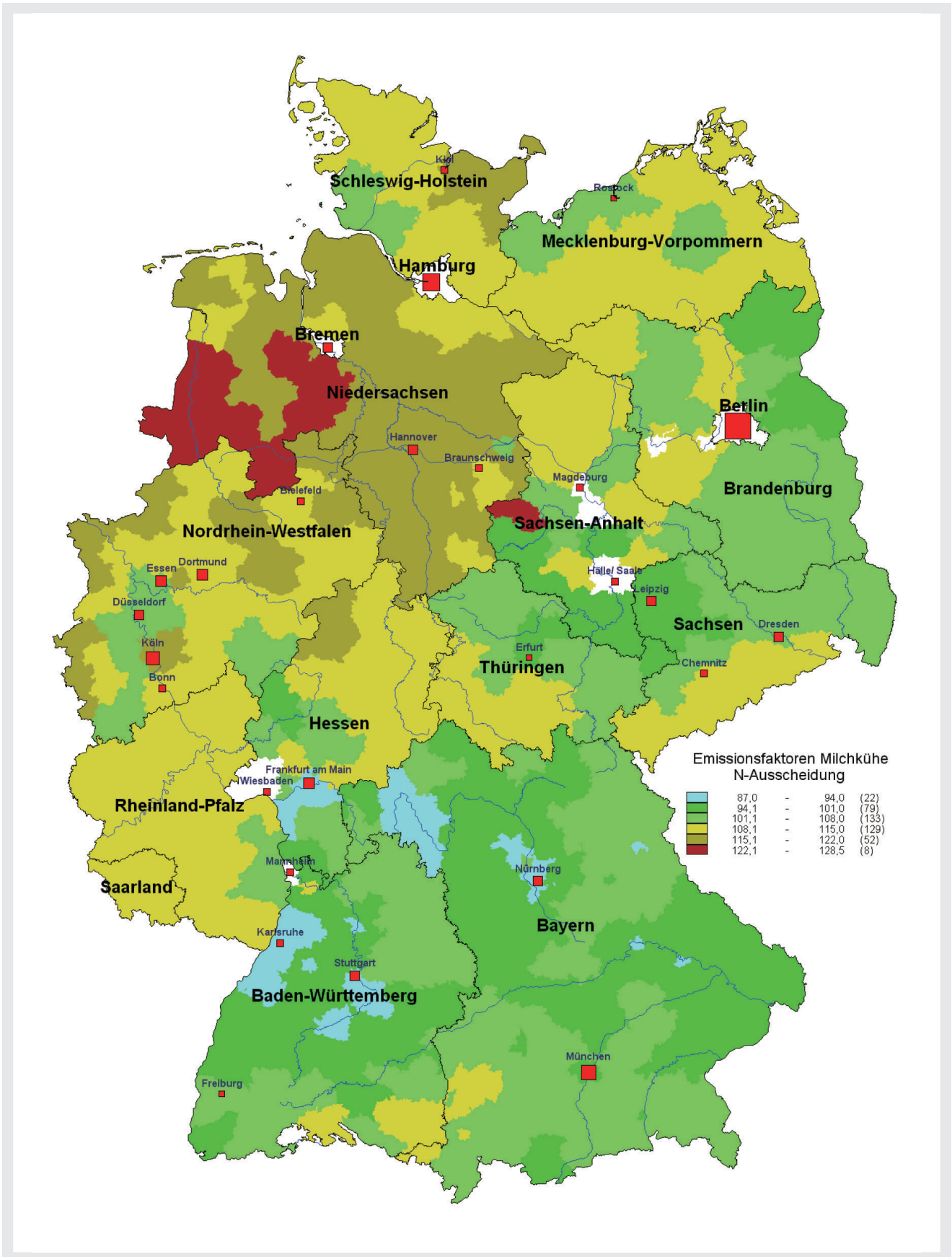
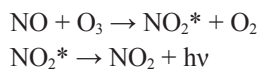

Figure 3 German ammonia inventory of emissions of dairy cows, Umweltbundesamt.^[7]

original, lower energy level. This phenomenon is called chemiluminescence (CLD).



This reaction is extremely fast and involves only NO. Coexisting gases in the sample are not affected at all. If the nitrogen monoxide is contained at low concentrations, the quantity of luminescence is proportionally low. Measuring nitrogen monoxide concentrations with this reaction is known as the CLD.^[8] For measuring the ammonia concentration in the sample, NH₃ is oxidized to NO by a converter in the NH₃-measurement device (NH₃-converter). So the ammonia content is measured indirectly via the nitrogen monoxide determination, which is the original function of HORIBA's APNA-370 (Air Pollution Nitrogen Analyzer for NO_x). The sample gas passes a catalyst (Figure 4) that oxidises ammonia and reduces NO_x to NO. Afterwards this NO portion is analysed by HORIBA's APNA-370 as NO_y (NO + NO₂ + NH₃). Another portion passes merely the NO₂-converter and is reduced to nitrogen monoxide (Figure 4). This NO amount is also measured by APNA-370 as NO_x (NO + NO₂). HORIBA's APNA-370 analyses the NO concentrations in two lines and calculates the NH₃ concentration that is the difference between both channels (NH₃= NO_y - NO_x).

Experimental Setup

The basic instrument HORIBA's APNA 370-NH₃ was developed by Junji KATO.^[9] First tests yielded that the sensitivity was very low and the response time very high. Therefore the system was completely revised. In a first step the electronically devices were rearranged in order to shorten the way of sample flow. Redundant parts were removed and tube diameters changed. The permeation oven (calibration unit) was placed in the converter unit.

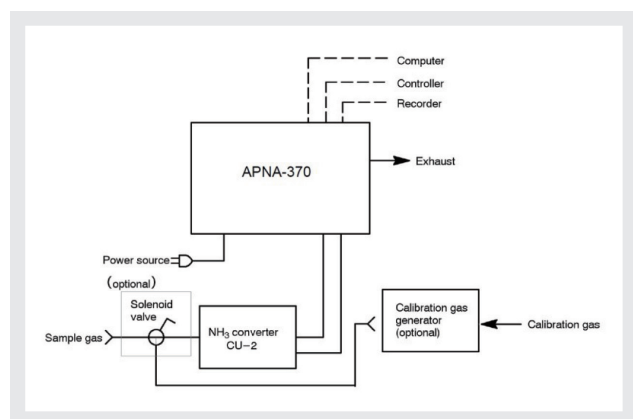

Figure 4 Flow Scheme of the NH₃-Converter Unit.

HORIBA's APNA 370 was not changed except of the removal of the calibration unit. Figure 5 gives an interior view on the converter unit.

In a second step every part and material used was overhauled and if necessary replaced by materials more suitable. A lot of parts consist of Polytetrafluoroethylene (PTFE). Unfortunately, this material strongly adsorbs ammonia. Better results are achieved with modified Perfluoroalkoxy Polymer (MFA) and Perfluoroalkoxy polymer (PFA) in second place that are copolymers of Tetrafluoroethylene and Perfluoroalkoxyvinylether. They have similar properties compared to PTFE. However the surface structure is less polar and smoother because of the ether groups.^{[10], [11]} Therefore less wall effects of ammonia can be observed while using MFA instead of PTFE.

Essential is the quality of the thermal NH₃-converter who oxidises NH₃ to NO. It should have a high efficiency for ammonia (>98 %) and should be operated at low temperature <600 °C due to a side reaction of nitrogen and oxygen to NO. The originally installed stainless steel helix converter has to be operated at 870 °C with an efficiency of 95 %. The stainless steel wears off after a while; it becomes porous and leaky. Since this moment the measured results are incorrect. Unfortunately this is a stealthy process, the exact date cannot be determined. Better results are achieved with a quartz glass pipe packed with stainless steel tubes (Figure 5). The efficiency is still 95 % by an operation temperature at 870 °C. Although the system remains air tight and produces reliable results. The low converter efficiency can be compensated by calibration in case it stays constant.

The stability of the system can be checked with an

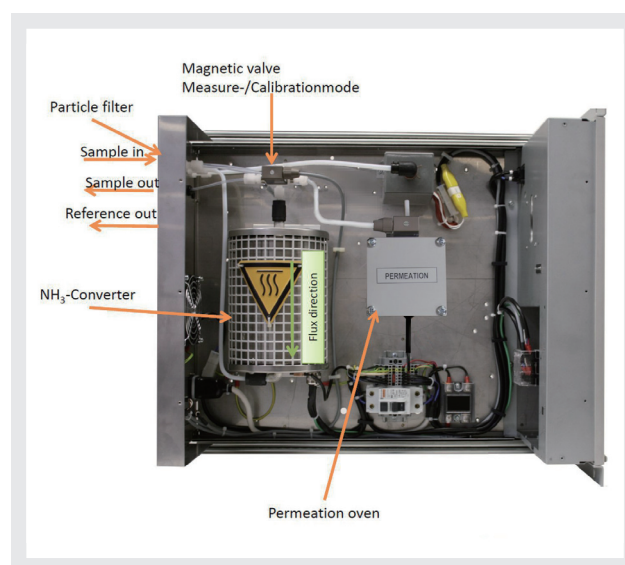

Figure 5 Interior View of the NH₃-Converter Unit.



Figure 6 Catalyst glass pipe close-up view placed in the oven. The glass pipe is filled with 9 tubes of stainless steel (7301 SS, 1.4301). Each tube has a diameter of 3 mm with void of 2 mm.

internal standard. For this purpose, a NO₂ permeation tube is installed in a heated oven in the NH₃-converter unit. The analyzer can conduct an automated daily zero and span gas control (e.g. every 23 hours^{*3}). NO₂ instead of NH₃ is used because NH₃ is a calculated value; the physical measurands are NO_x and NO_y (in this case represented by NO₂). Instrument drifts can be determined by a mismatch of the NO_x/NO_y-ratio and a NH₃-concentration different zero.

*3: Minimum requirement according to DIN EN 14211^[12]

Span gas Production

For accurate measurements the calibration of the analyzer is required. HLUg established and validated a calibration standard for NH₃ in their lab. The method of static injection^{*4}, standard method of HLUg for gaseous and liquid components, failed due to strong adsorption effects. The permeation method^{*5} (adding pure ammonia from a permeation tube to a constant carrier gas) produces a repeatable span gas. The validation of the permeation method results in a relative extended measuring uncertainty of approximately 1 %.

*4: DIN EN ISO 6144^[13], VDI 3490-14^[14], VDI 2100-4^[15]

*5: ISO 6145-10^[16], VDI 3490-9^[17], VDI 2100-4^[15]

Results and Discussion

Validation

General

Type approval tests give the user the security that the measuring equipment is suitable for the use in automated ambient air monitoring network.^[19] The test procedure is divided in two parts - the requirements on the construction and the evaluation of the performance characteristics.^{[20], [21]} The modified instrument was validated according to the regulations of the German and European type approval test procedures.^[12, 20, 21] For NH₃ no specific criteria are defined therefore the existing requirements for NO₂ are adopted. The analyzer meets all requirements on the construction such as a telemetric data transmission, the transmission of operation and error states or the possibility of an automatically function control. The validation includes a large number of system parameters. In the main the modified device passes the criteria. This article focuses on the most important.

Detection limit and measurement uncertainty

The detection limit is defined as the 3-fold standard deviation with a maximal value of 3 µg/m³.^[20] The actual detection limit is 2 µg/m³. Therefore the requirements are fulfilled and the detection limit is sufficient for the measuring task. The data quality objectives request a relative expanded uncertainty of 15 % for inorganic components (e.g. NO₂) and 25 % for other compounds such as particles or benzene^[22]. The uncertainty of the APNA 370 NH₃ amounts to 19.9 %. The criteria for NO₂ cannot be met yet; although the less strict requirements for benzene can be fulfilled.

Lack of fit

The lack of fit of linearity of the calibration function was tested. In the range of 0-300 ppbv NH₃ the detector is linear (Figure 7). The relative residuals of the linear regression function meet the criteria.

Response time

The response time is the time needed for the measured signal to reach 90 % of the nominal value. It may differ 5 % of the average determination; an average time of 3 min results in a response time of 9 s.^[20] The instrument has a response time of 30 min; this result does not meet the

requirements. However this is a clear performance improvement.

Drift

The temporal change of the measured values at zero point shall not exceed 3 µg/m³ (2.13 ppbv) during 24 hours.^[20] The trend diagram (Figure 8) shows already a drift behavior although the requirements are passed except of the running-in phase. Figure 9 displays the absolute differences from the nominal value (zero) with the limits.

Interference

The interference of the device to the components NO₂, SO₂, and water moisture was tested. The results are seen in Table 1. The analyzer shows interferences to SO₂ in the region of 5 %. This discrepancy can be negligent because the SO₂-concentration of ambient air decreased strongly in the last years. The Hessian annual average for SO₂ is amounted to 6 µg/m³ in 2007.^[23] The recovery rate of a sample gas with a water content of 50 % is located at 13 %.

Field Measurements

Since 2004 respectively 2009 the Hessian ambient air monitoring network measures ammonia at three rural sites (Linden (2004), Spessart (2004), and Witzenhausen (2009)). The NH₃-pollution is low compared to other regions in Europe. The annual average amounts to 2-3 µg/m³. Due to a close pig fattening establishment the location in Linden is most interesting. The nearby fields are under cultivation. As a result the background level is higher and high concentration peaks occur during fertilization. Figure 10 and 11 are examples for NH₃-trends at the monitoring site Linden. The blue line indicates the ammonia concentration while the red line shows the corresponding ambient air temperature.

Conclusions and Perspective

HORIBA's APNA 370 NH₃ was modified and validated according the German and European type approval tests by the Hessian Agency for Environment and Geology

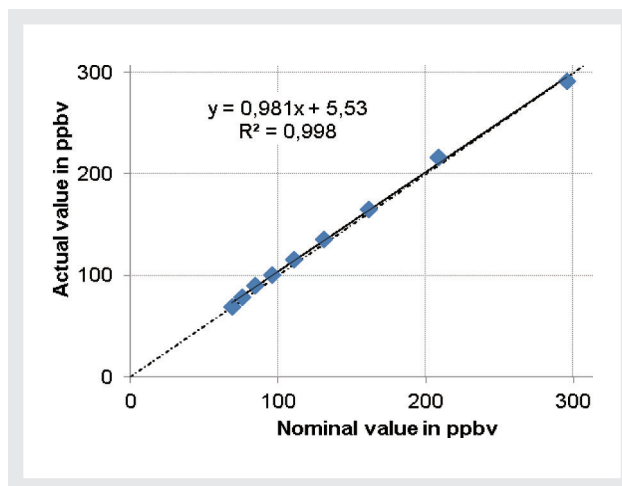

Figure 7 Lack of fit with the linear regression function

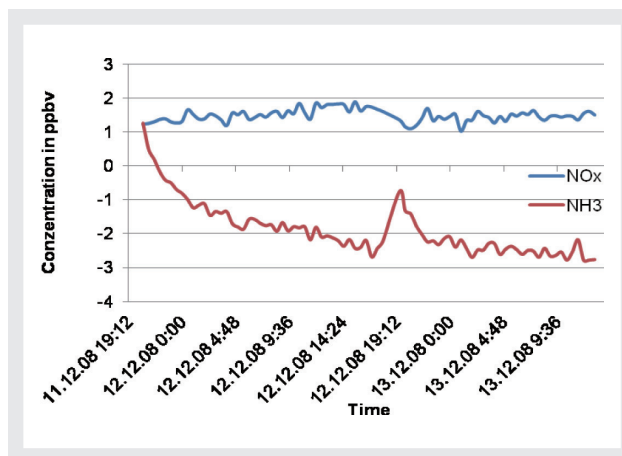

Figure 8 Zero Drift of the NH₃ and NO_x-Signals: Trend diagram

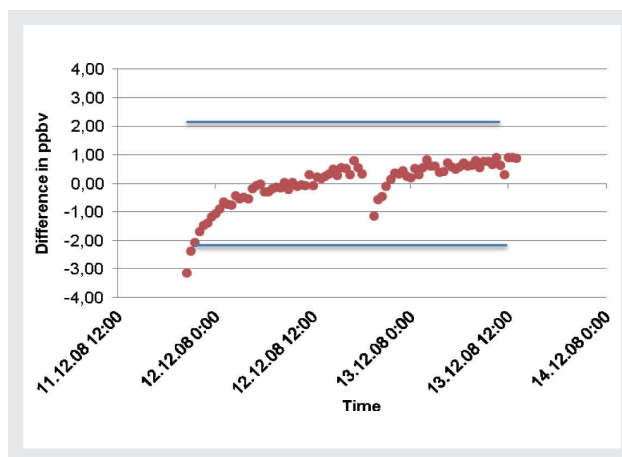

Figure 9 Zero Drift of the NH₃-Signal: Absolute differences of the nominal value

Table 1 Interferences at a test gas of 102 ppbv NH₃ (SO₂ 100 ppbv, NO₂ 100 ppbv, H₂O 50 %)

Interference	NH ₃ -Conc. ppbv	NH ₃ -Conc. interference ppbv	with Difference ppbv	Difference %
SO ₂	102	107	5	4.9
NO ₂	102	102	0	0.0
H ₂ O	102	89	-13	-13.0

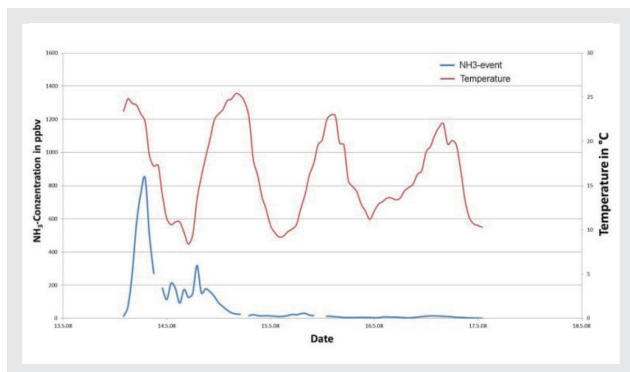

Figure 10 NH₃ trend at the ambient air monitoring site Linden, September 2007, Hessian ambient air monitoring cadastre (HLUG).^[18]

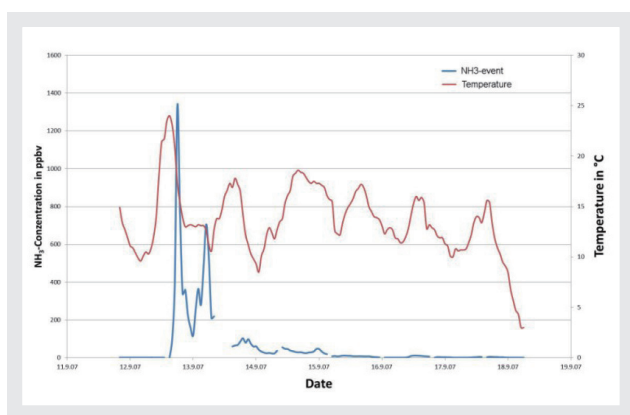

Figure 11 NH₃ trend at the ambient air monitoring site Linden, May 2008, Hessian ambient air monitoring cadastre (HLUG).^[18]

(HLUG). After modification the system fulfills most of the requirements although there is still need for improvements.

Response time: At present the analyzer cannot be used in traffic related sites due to fast concentration changes. The pollution situation at agricultural locations can be monitored with an adequate resolution (see **Field Measurements**) although NH₃-monitoring at traffic related sites becomes more important due to changes in the motor technique of diesel-engine vehicles (SCR-cat).^[24]

Drift: The criterion is met although the instrument drift should be improved.

Interference: To deal with interferences from high water moisture, you have to consider the following aspect: The unit consists of two separate, parallel installed conversion pathways. The first one is the NO_x converter operating at 230 °C and the second is the NH₃ converter running at 830-870 °C. As a conclusion and related to the temperature difference, there is a potential difference in air humidity. To avoid the cross sensitivity a molecular

sieve with less than 3 Angstrom could be installed prior the converter pathways, just like dryer. It would be the optimal pore size due to the different molecular diameters of H₂O and NH₃. This application still needs to be tested.

Converter efficiency: Currently there are theoretical thoughts about exchanging the stainless steel tubes (Figure 6) by Molybdenum oxide (MoO) or a Platinum/Rhodium grid. Tests were performed with a molybdenum oxide granulate filling. First results display an efficiency of 98 % by 450 °C. This low temperature converter reduces measuring errors due to the effect of nitrogen combustion. Platinum/Rhodium grids are used in the industrial NO production (Ostwald process). There, NH₃ is selectively oxidized to NO.

References

- [1] World Health Organisation (WHO), "Air quality guidelines for Europe", 2th Edition, *WHO Regional Publications*, European Series 91, ISBN 13563, Kopenhagen, 2000
- [2] Erste Allgemeine Verwaltungsvorschrift zum Bundes-Immissionsschutzgesetz (Technische Anleitung zur Reinhaltung der Luft - TA Luft), 24. Juli 2002, GMBL. 2002, Volume 25 - 29, 511 - 605, 2002
- [3] Protocol to abate acidification, eutrophication and groundlevel ozone, United Nations Economic Commission for Europe, convention on long-range transboundary air pollution, signed by 27 member states am 1. December 1999 in Goteborg
- [4] Directive 2001/81/EC of the European Parliament and of the Council of 23 October 2001 on national emission ceilings for certain atmospheric pollutants, THE EUROPEAN PARLIAMENT AND THE COUNCIL OF THE EUROPEAN UNION, *Official Journal L* 309, 27/11/2001 P. 0022 - 0030
- [5] Bayrisches Landesamt für Umweltschutz (BLFU), "Ammoniak und Ammonium", BayLFU 2004 - PSI / Umweltberatung Bayern, August 2004 [6] Umweltbundesamt, Umweltdaten, 2002
- [6] Umweltbundesamt, Nationale Trendtabelle für die deutsche Berichterstattung atmosphärischer Emissionen seit 1990 (15.04.2011), <http://www.umweltbundesamt.de/publikationen.htm>, retrieved 2012-07-23
- [7] Döhler, H., Eurich-Menden, B., Dämmgen, U., Osterburg, B., Lüttich, M., Bergschmidt, A., Berg, W., Brunsch, R., BMVEL/UBA-Ammoniak-Emissionsinventar der deutschen Landwirtschaft und Minderungsszenarien bis zum Jahre 2010, UBA-Forschungsbericht 299 42 245/02, UBA-FB 00249, ISSN 0722-186X, P. 109
- [8] Baumbach, G., *Luftreinhaltung*, Springer-Verlag, 1990
- [9] Kato, J., Measurement technique and its application to trace components of atmospheric gas, *HORIBA Readout* 10, 30-35, 2006
- [10] Falbe, J., Regitz, M. (issuers), *Römpf Lexikon Chemie*, 10th Edition, Volume 4, 3180f, Georg Thieme Verlag, 1998
- [11] DuPont, http://www2.dupont.com/Teflon_Industrial/en_US/tech_info/techinfo_compare.html, retrieved 2012-07-23

- [12] DIN EN 14211 “Luftqualität - Messverfahren zur Bestimmung der Konzentration von Stickstoffdioxid und Stickstoffmonoxid mit Chemilumineszenz”, Beuth Verlag, 2005
- [13] DIN EN ISO 6144, “Gasanalyse - Herstellung von Prüfgasen - Volumetrisch-statisches Verfahren”, Beuth Verlag, 2006
- [14] VDI 3490-14, “Messen von Gasen - Prüfgase - Herstellung von Prüfgasen nach der volumetrische-statischen Methode unter Verwendung von Glasbehältern”, Beuth Verlag, 1994
- [15] VDI 2100-4, “Messen gasförmiger Verbindungen in der Außenluft - Messen von Innenraumluftverunreinigungen - Gaschromatographische Bestimmung organischer Verbindungen - Kalibrierverfahren als Maßnahme zur Qualitätssicherung”, Beuth Verlag, 2004
- [16] DIN EN ISO 6145-10 “Gasanalyse - Herstellung von Kalibriergasgemischen mit Hilfe von dynamisch-volumetrischen Verfahren - Teil 10: Permeationsverfahren”, Beuth Verlag, 2008
- [17] VDI 3490-9, “Messen von Gasen - Prüfgase - Herstellung durch Permeation der Beimengung in einen Grundgasstrom”, Beuth Verlag, 1980
- [18] Hessisches Landesamt für Umwelt und Geologie (HLUG), Ambient air monitoring cadastre
- [19] VDI 4203-1, “Prüfpläne für automatische Messeinrichtungen - Grundlagen”, Beuth Verlag, 2001
- [20] VDI 4202-1 “Mindestanforderungen an automatische Immissionsmesseinrichtungen bei der Eignungsprüfung - Punktmessverfahren für gas- und partikelförmige Luftverunreinigungen”, Beuth Verlag, 2002
- [21] VDI 4203-3, “Prüfpläne für automatische Messeinrichtungen - Prüfprozeduren für Messeinrichtungen zur punktförmigen Messung von gas- und partikelförmigen Immissionen”, Beuth Verlag, 2004
- [22] Directive 2008/50/EC of the European Parliament and of the Council of 21 May 2008 on ambient air quality and cleaner air for Europe, THE EUROPEAN PARLIAMENT AND THE COUNCIL OF THE EUROPEAN UNION, *Official Journal L 152,11/061/2008*
- [23] Hessisches Landesamt für Umwelt und Geologie (HLUG), “Lufthygienischer Jahresbericht 2007, Teil 1: Kontinuierliche Messungen”, 2007
- [24] Feßmann, J., Orth, H., Angewandte Chemie und Umwelttechnik für Ingenieure, *ecomед Sicherheit*, 2th Edition, 2002



Wilma TRAVNICEK

Master of Science in Physics
 Department of Pollution Control and Radiation Protection
 Hessian Agency for Environment and Geology



Stefan KARWISCH

Teamleader Service Engineering
 Process & Environment
 HORIBA Europe GmbH



Grischa P. FEUERSÄNGER

Marketing and Project Engineering
 Process & Environment
 Office Leichlingen
 HORIBA Europe GmbH
 Dr. Rer. Nat.